

WARNING: READ THIS FIRST

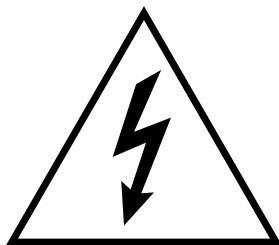

This symbol is intended to alert the user to the presence of important operating and maintenance (servicing) instructions in the literature accompanying the appliance.



This symbol is intended to alert the user to the presence of un-insulated dangerous voltage within the product's enclosure that may be of sufficient magnitude to constitute a risk of electric shock to persons.

IMPORTANT SAFETY INSTRUCTIONS

Use in countries other than the U.S.A. may require the use of a different line cord or attachment plug, or both. To reduce the risk of fire or electric shock, refer servicing to qualified service personnel. To reduce risk of fire or electric shock do not expose this product to rain or moisture.

GROUNDING INSTRUCTIONS

This product must be grounded. If it should malfunction or break down, grounding provides a path of least resistance for electric current, reducing the risk of electric shock. This product is equipped with a cord having an equipment-grounding conductor and a grounding plug. The plug must be plugged into an appropriate outlet properly installed and grounded in accordance with all local codes and ordinances.

DANGER

Improper connection of equipment grounding conductor can result in the risk of electric shock. Check with a qualified electrician or service personnel if you are in doubt as to whether the product is properly grounded. Do not modify the plug provided with this product. If it will not fit the outlet, have a proper outlet installed by a qualified technician.

CAUTION

If the 6200, ESI is rack mounted, a standard 19 inch open frame rack must be used.

USER-MAINTENANCE INSTRUCTIONS

1. The ESI should be kept clean and dust free. Periodically wipe the unit with a clean, lint free cloth. Do not use solvents or cleaners.
2. There are no user lubrication or adjustment requirements.
3. Refer all other servicing to qualified service personnel.

INSTRUCTIONS PERTAINING TO A RISK OF FIRE, ELECTRIC SHOCK, OR INJURY TO PERSONS

WARNING; When using electric products, basic precautions should always be followed, including the following:

1. Read **all** instructions before using the ESI.
2. To reduce the risk of injury, close supervision is necessary when the ESI is used near children.
3. Do not use the ESI near water — for example near a bathtub, washbowl, kitchen sink, in a wet basement, on a wet bar, or near or in a swimming pool.
4. Situate the ESI so that its location or position does not interfere with its proper ventilation.
5. The ESI should be located away from heat sources such as radiators, heat registers, fireplaces, stoves, or ovens.

6. The ESI should only be connected to a power supply of the type described in the operating instructions and as marked on the product.
7. Care should be taken so that objects do not fall and liquids are not spilled into the enclosure of the ESI through openings.
8. This ESI may be equipped with a polarized line plug (one blade wider than the other). This is a safety feature. If you are unable to insert this plug into the outlet, do not defeat the safety purpose of the plug. Contact an electrician to replace your obsolete outlet.
9. The power supply cord of the ESI should be unplugged from the outlet when left unused for a long period of time.
10. This product, in combination with an amplifier and headphones and speakers, may be capable of producing sound levels that could cause permanent hearing loss. Do not operate for a long period of time at a high volume level or at a level that is uncomfortable. If you experience any hearing loss or ringing in the ears, consult an audiologist.
11. The product should be serviced by qualified service personnel when:
 - A. The power supply cord has been damaged; or
 - B. Objects have fallen, or liquid has been spilled into the product; or
 - C. The product has been exposed to rain; or
 - D. The product has been dropped or the enclosure damaged; or
 - E. The ESI does not operate normally or exhibits a marked change in performance.
12. All servicing should be referred to qualified service personnel.

SAVE THESE INSTRUCTIONS

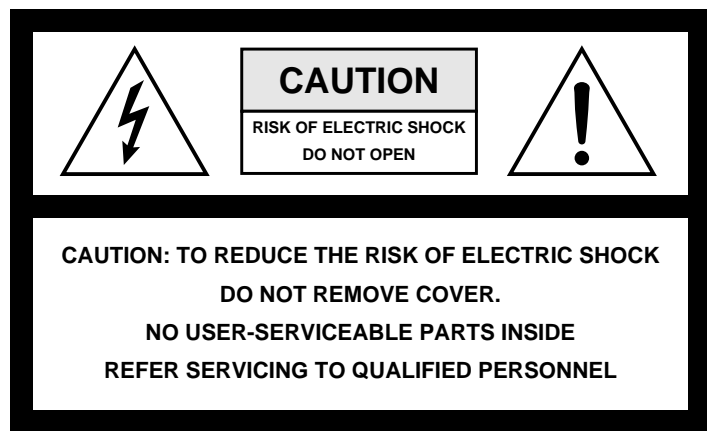

RADIO and TELEVISION INTERFERENCE

The equipment described in this manual generates and uses radio-frequency energy. If it is not installed and used properly — that is, in strict accordance with our instructions - it may cause interference with radio and television reception.

This equipment has been tested and complies with the limits for a Class A computing device in accordance with the specifications in Subpart J of Part 15 of the FCC rules. These rules are designed to provide reasonable protection against such interference in a residential installation. However, there is no guarantee that the interference will not occur in a particular installation, especially if a “rabbit ear” TV antenna is used.

If the ESI does cause interference to radio or television reception, you can try to correct the interference by using one or more of the following measures:

- Turn the television or radio antenna until the interference stops.
- Move the ESI to one side or the other of the television or radio.
- Move the ESI farther away from the television or radio.
- Plug the ESI into an outlet on a different circuit than the television or radio.
- Consider installing a rooftop antenna with a coaxial lead-in between the antenna and television set.

Contents

1	General Instructions	
	Introduction	3
	The ESI	4
	Connection Instructions	6
	Connection Diagram	7
	Connecting to an Unformatted Hard Disk	9
	Sampling Basics	10
	Definitions	11
	Additional Definitions	15
2	Controls	
	Master Volume	21
	Data Entry Control	21
	Inc/Dec Buttons	21
	Ten Key Pad	21
	Escape	21
	Enter	21
	Cursor/Page	22
	Preset Selection	22
	Save Bank	23
	Load Bank	23
	Drive Select	24
	Audition	24
	Trigger Mode	24
	Multimode	25
	Transpose	25
3	Guided Tours	
	Tour 1: Basics	29
	Tour 2: Selecting Zones	33
	Tour 3: Dynamic Processing	35
	Tour 4: Realtime Controls	42
	Tour 5: Sampling	45
	Tour 6: Digital Processing	47
	<i>A Practice Sampling Session</i>	48
	Tour 7: Managing the Bank	54
	Tour 8: On Your Own	54

The Modules

4 Master/Global

1. Master Tune	57
2. Rename Bank	57
3. Erase Bank	58
4. Effects	58
5. Export.....	59
6. Memory Available	60
7. Disk Utilities	60
0. SCSI Setup	61
1. Mount Drives	62
2. Rename Disk Bank	62
3. Erase Disk Bank	63
4. Lock Bank & Drive	63
5. Disk Status	64
6. Format Disk	65
7. Backup	67
8. Special	70
1. Recalibrate	71
2. Contrast	71
3. Headroom/Boost	72
4. Main Output Format	73
5. Software Version	73
6. View Channels	74
7. Trigger Buttons	74
8. RAM Test.....	75
9. MIDI	76
1. MIDI Mix	77
2. MIDI Globals	78
<i>Basic Channel</i>	78
<i>MIDI Mode</i>	78
<i>Continuous Controller Assignment</i>	79
3. MIDI Load Bank	81
4. MIDI Volume Pedal	81
5. MIDI Volume/Pan	82
6. Multimode Enable	82
0. Import Options	83
0. Akai Import	83
1. Emax II Import	89

5	Sample Management	
	0. Select Sample	95
	1. Load Sample	95
	2. Rename Sample	96
	3. Erase Sample	97
	4. Copy Sample	98
	5. Sample Setup	99
	6. Place Sample	101
	7. Arm Sampling	102
	8. Force Sampling	102
	9. MIDI Sample Dump	103
6	Preset Management	
	1. Load Preset	107
	2. Rename Preset	108
	3. Erase Preset	109
	4. Copy Preset	109
	5. Create Preset	110
	6. Preset Size	111
	7. Merge All Presets	111
7	Digital Processing	
	Background	114
	0. Select Sample	121
	1. Setup	121
	2. Loop	122
	3. Truncation	125
	4. Copy Region	125
	5. Cut Region	127
	6. Paste Region	128
	7. Digital Tools I	131
	0. Sample Calculator	131
	1. Taper	132
	2. Gain Change	133
	3. Reverse Section	135
	4. Stereo <-> Mono	135
	5. Left <-> Right	136
	6. DC Filter	136
	7. Sample Integrity	137
	8. Digital Tools II	138
	0. Sample Rate Convert	139
	1. Digital Tuning	140
	2. Compressor	141
	3. Parametric Equalizer	145
	4. Time Compression	146

5. Pitch Change	147
6. Transform Multiply	148
7. Doppler/Pan	149
8. Sonic Enhancer	155
9. Undo	156
8 Preset Definition	
0. Realtime Controls	161
1. Load Zone	166
2. Edit Assignment	169
3. Erase Zone	172
4. Copy Zone	173
5. Crossfade/Switch	176
6. Velocity Switch/Preset Link	183
7. Pitch Bend Range	183
8. Portamento/Attack	184
9. Effects	185
9 Dynamic Processing	
Background	189
0. Select Zone	196
1. Setup	197
2. VCA	198
3. VCF	200
4. LFO	202
5. Auxiliary Envelope	204
6. Velocity To	205
7. Keyboard Mode	207
8. Realtime Control Enable	208
9. Channel Assignment	209
10 Appendix	
Effects	215
Effects Parameters	231
Using SCSI	237
Disk Drive Compatibility	241
Keyboard Character Chart	242
ESI Menu Map	243
MIDI Key Number Chart	244
MIDI Implementation Chart	245
Specifications	246
Error Codes	247
Troubleshooting	249
Warranty	253
Index	255

1

General Instructions

Introduction	3
The ESI	4
Connection Instructions	6
Connection Diagram	7
Connecting to a Hard Disk	9
Sampling Basics	10
Definitions	11
Additional Definitions	15

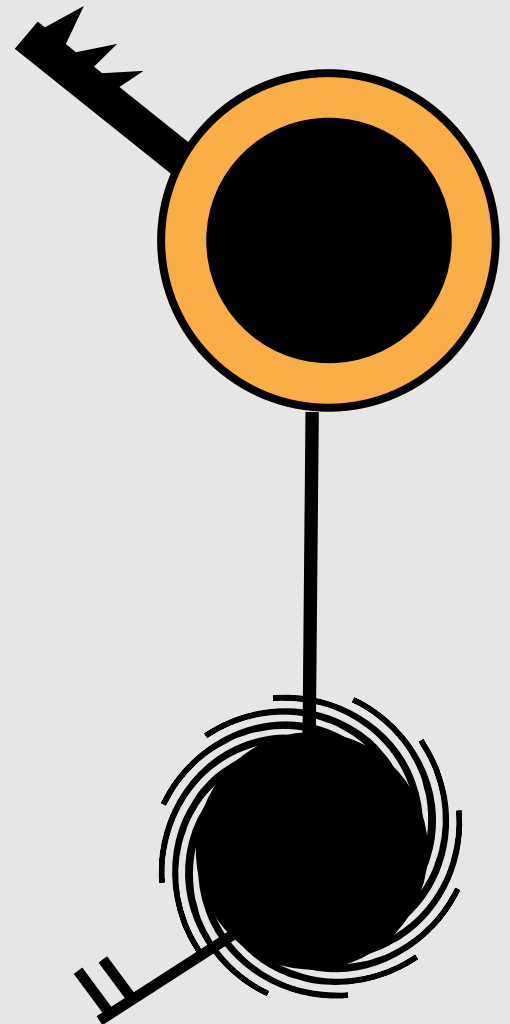

Introduction

Welcome to the ESI Digital Sampling System. Congratulations are definitely in order! The many functions of ESI are detailed in this manual by their module. Screen displays and step-by-step instructions are described for all aspects of use and operation. Sidebars are used to highlight important points or to give useful operational tips which might not be readily apparent.

If you are totally unfamiliar with samplers and synthesizers in general, you may need more information than this manual provides. We suggest that you read some of the many books and magazines on the subject of music synthesis. This will help you to get the most out of this extremely powerful instrument.

We encourage you to take a moment now to read the E-mu Systems warranty and to fill out and send in your warranty registration card. By doing so, you are assured of receiving news of all updates and manual revisions.



ESI

ESI is the very latest in the long line of high quality and affordable E-mu sampling products. ESI features 22.05 kHz and 44.1 kHz sampling rates and 16-bit resolution for CD quality sound. Sampling can be performed in either mono or true stereo. 64 channels of polyphony allow you to stack sounds or create lush sequences without fear of channel “ripoff”. The user-upgradable memory can be expanded to a maximum of 128 Mbytes using standard SIMM modules (Details and installation are available at your E-mu dealer).

The ESI has full access to the huge library of sounds available from E-mu and other sources. It is fully compatible with the legendary EIII and EIIIX libraries, and can import Emax II and Akai S1000/S1100 banks. In many cases, the ESI can import and convert programs faster than the source unit!

The advanced features of the ESI make sampling easy. Samples can be automatically truncated, normalized and placed on the keyboard as the sample is taken. ESI also contains advanced tools such as Auto Correlation, Loop Compression and Crossfade Looping which allow even the most difficult sounds to be easily looped.

Samples can be digitally spliced and mixed with other samples, and dynamically controlled from the keyboard using velocity and positional crossfading and switching functions. Advanced digital processing features such as Sample Rate Conversion, Compressor, Digital Parametric Equalizer and Digital Tuning allow you to shape raw samples more quickly and with greater precision than computer based systems.

Additional digital processing functions include: Time Compression and Expansion, which shorten or lengthen the time of samples without changing the pitch; and Doppler/Pan, which allows you to move samples forward and backwards in space as well as from side to side.

The Sonic Enhancer adds brilliance and cut to a sample, helping it to stand out in a mix.

The ESI contains 19 different filter types for each of its 64 channels. The digital filters are very “analog sounding” and implement the following filter types:

- 12, 24, or 36 dB/octave Lowpass filters with Resonance
- 2nd & 4th order Highpass filters with Resonance
- 2nd & 4th order Bandpass filters with Resonance
- Contrary Bandpass filter
- Three types of Swept EQ filters
- Three Phasers and one Flanger filter with Resonance
- Two morphing Vocal Formant filters
- Bottom Feeder
- Original ESI-32 24 dB/octave Lowpass filter

Modulation sources include three AHDSR envelope generators and a multi-wave LFO per channel, as well as full MIDI modulation control over virtually every parameter.

The ESI's unique Trigger Mode allows up to ten different samples to be triggered from the front panel without connecting a keyboard, making it an ideal tool for DJ's.

The ESI is 16 part multi-timbral which means you can create complex sequences and sound effects.

Four polyphonic audio outputs with integral submix returns allow you to process certain sounds separately and return them to the main outputs without using up precious mixer channels. The Turbo option card adds four additional submix outputs plus an Effects main output.

The ESI can access up to 999 samples per bank arranged in up to 256 presets. The integral 3.5" floppy disk drive provides a convenient means of storing and loading banks. A built-in SCSI interface provides access to external high density media such as hard disks, magneto-optical disks or CD ROM.

A digital interface, available on the “Turbo” option, facilitates the transfer of stereo digital audio between digital recorders, mixers, etc.

The Turbo option card also contains two stereo 24-bit digital effects processors which add Reverb, Delay, Flanging and Distortion effects to the ESI. Over 70 effects are implemented which can be applied on a per MIDI channel basis or by keyboard “Zone”. Each preset can have its own effect program when ESI is in Omni or Poly mode.

In developing ESI, we retained the logical and easy-to-use interface of the industry-proven EIIIIX and enhanced it with our state-of-the-art G-chip and H-chip hardware. The G-chip allows smooth sample transposition over a wide range while the H-chips retain the warm character of analog filters.

ESI is an extremely powerful and reliable, seventh generation instrument. We at E-mu Systems sincerely hope it will help you realize and further your musical dreams.

Connecting to a Mixer

Main Outputs: The ESI has provisions for a variety of output connection schemes. The most common hookup is probably using the main stereo outputs. Output level is -10 dBm (approximately 1-2 volts RMS). Output impedance is 1K ohm.

★ **Tip:** Inserting a standard mono plug halfway into either of the sub output jacks allows you to sum into the main outputs without a special cable. This is a handy feature for those times when you run out of mixer channels.

Submix Outputs/Mix In: In addition to the main stereo outputs, the ESI has an additional pair of submix outputs which can be used when individual processing on specific instruments is desired. Any combination of channels can be programmed to appear at the submix output pair. Any keyboard zone (key range) can also be assigned to the submix pair using the Output Channel function in the Dynamic Processing module. MIDI channels can be assigned to the submix pair using the Multimode Mix function in the Master/Global module.

★ **Tip:** The submix outputs use a “plug sensing” scheme which re-routes the signal to the main outputs if a plug is not inserted.

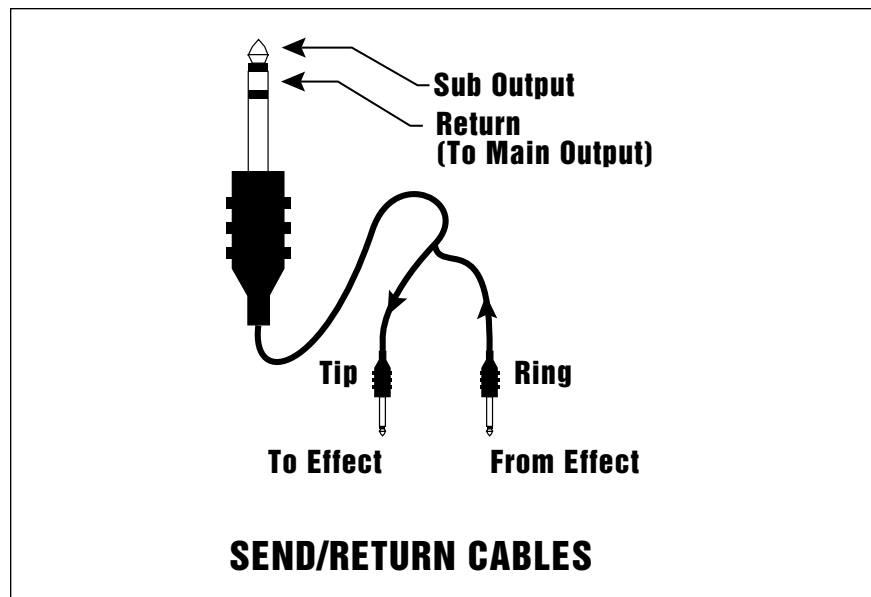

The Submix Outputs are stereo jacks with -10 dBm outputs on the tip of the jack. Output impedance is 1K ohm. The ring of each submix jack is a return input to the main outputs. By using a special cable shown above, specific presets or MIDI channels can be externally processed and then returned to the main mix.

Stereo Headphone Output: The headphone output is located on the left side of the front panel and is capable of driving all types of stereo headphones. The output level is controlled by the master volume control.

Turbo Option Outputs: The optional Turbo card contains three additional output channel pairs: FX, Sub 2 and Sub 3. The stereo outputs are accessed using a stereo plug adapter cable. The FX output is a duplicate of the main outputs run through the effects processors. When MIDI channels or Zones are programmed to “Main,” they appear at both the FX and Main outputs. Submix outputs 2 and 3 incorporate “plug sensing” which reroutes signals to the FX outputs if a plug is not inserted into the submix jack.

Connection Diagram

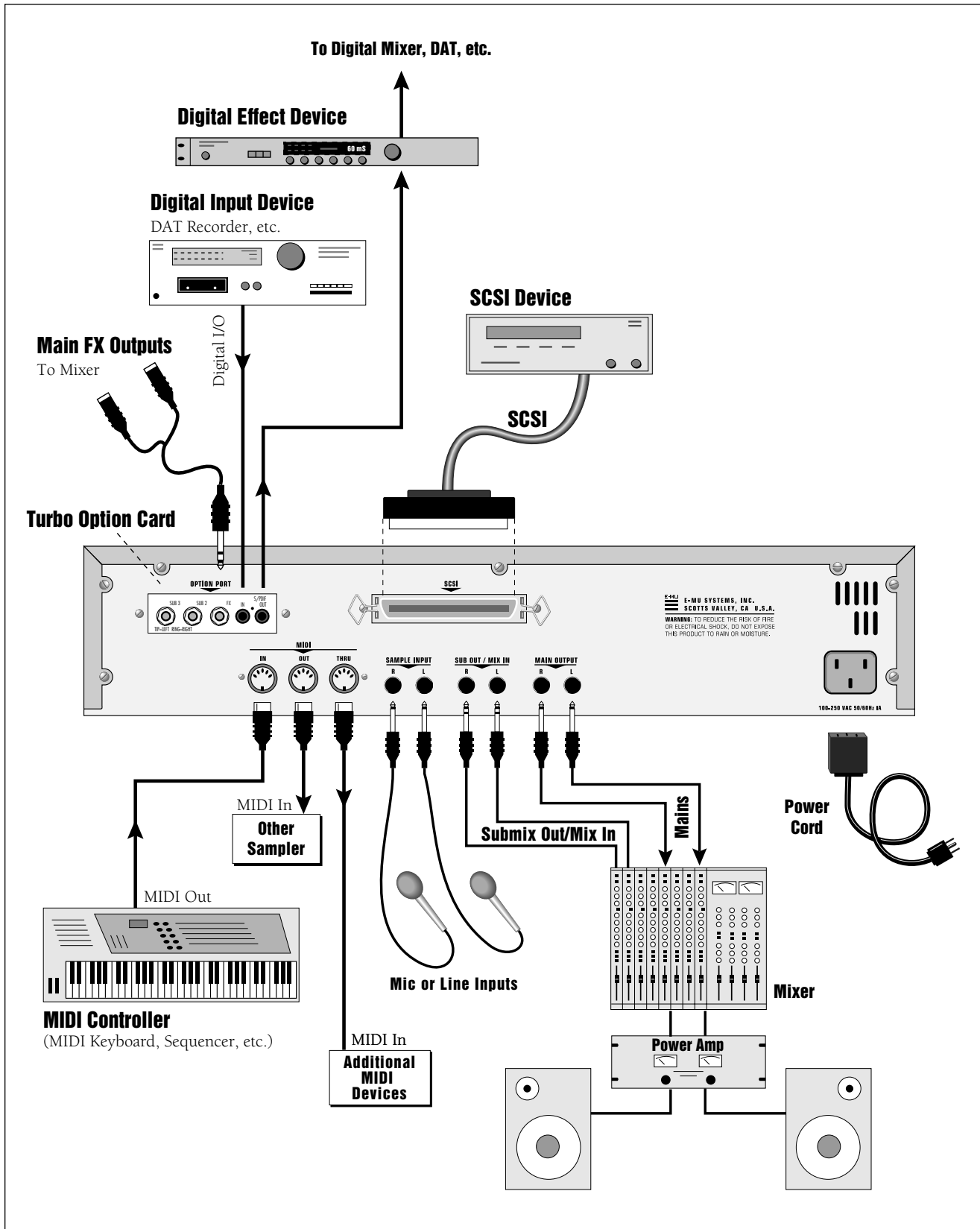

Sample Inputs

The two sample input jacks accept any low to high level input (microphone to line level). Input impedance is 10K. The gain of the sample input preamplifier is controlled from the setup screen in the Sample Management module. When in the Sample Management module the sample inputs can be monitored from the main outputs or the headphone jack.

MIDI Connection

ESI provides a MIDI IN, a MIDI OUT and a MIDI THRU port.

- The **MIDI IN** port connects to the MIDI OUT port of an external MIDI controller which could be a keyboard, a sequencer, MIDI drum kit or whatever. Note that the ESI can only respond to information that your controller transmits. If your MIDI keyboard does not have velocity and pressure sensitivity, the ESI will not respond to velocity and pressure.
- **MIDI OUT** can be connected to another MIDI instrument or computer. The MIDI OUT jack is used to transmit MIDI sample dump information (transfers sample data).
- **MIDI THRU** simply re-transmits any information received at the MIDI IN port. Use cords that have been designed specifically for MIDI. While regular 5 pin DIN cords may work, they are not shielded correctly for MIDI use and may cause ground loops between equipment.

! Caution: *Only use cords designed specifically for MIDI.*

Footpedal and Footswitch Connection

Control pedals and footswitches can be connected if your MIDI keyboard has inputs for them (most do). The MIDI keyboard translates the controller movements into MIDI data which is received by ESI. Controller data is sent over MIDI on a particular *continuous controller* number assigned by your MIDI keyboard. ESI must be set to receive the data using the same continuous controller number.

For more information, see MIDI Globals on page 78.

! Caution: *If you plan on having the ESI Turbo Option Kit installed, please use only low-profile SIMMs when adding RAM to your ESI-4000.*

110V / 220V Operation

The ESI may be used in either 110 volt or 220 volt environments at either 50 Hz or 60 Hz. No change of voltage settings is required.

ESI automatically switches itself for 110 or 220 volt operation.

Digital I/O (Turbo option)

The optional Turbo card contains a digital interface which allows ESI to transfer digital audio back and forth with other digital devices equipped with S/PDIF digital I/O. Keeping the signal in the digital domain is desirable to keep the signal to noise level as high as possible.

The digital input allows you to sample directly from a DAT recorder or other digital device. The digital output reflects the data at the stereo outputs of the ESI. See the Sample Management module and Main Output Format (located under Special in the Master/Global menu) for more information.

★ **Tip:** *If you plan on expanding the memory beyond 4 MB, a mass storage device is almost a necessity. When dealing with large banks of up to 128 MB, a floppy disk drive simply doesn't cut it, even for back-up. A hard disk is an absolute must! Furthermore, the extremely useful "Undo" function will not work without a hard drive attached.*

! **Caution:** *NEVER connect or disconnect the SCSI cable while power is applied to either the ESI or the SCSI device. Doing so may cause serious damage to both units!*

★ **Tip:** *Use the "Mount Drives" utility (Master/Global, Disk Utilities, 1) whenever an external SCSI device does not appear in the list of available devices.*

SCSI

The SCSI connector is a high-speed parallel interface which is used to connect the ESI with internal or external mass storage devices such as hard disks or magneto-optical discs. The SCSI port can be used to link the ESI with an external computer for extremely fast file transfers. The ESI also supports SMDI (SCSI Musical Data Interchange protocol) which allows transfer of samples over SCSI.

For more information on SCSI installation, see, "Using SCSI" in the Appendix of this manual. Also refer to the manual that accompanies your external SCSI device.

Following are step-by-step instructions on how to connect the ESI to a SCSI hard disk or other SCSI storage device.

Connecting the ESI to an External, Unformatted Hard Disk

Important: Make sure that all power to the ESI and the SCSI device is turned OFF.

1. **Position the SCSI device and the ESI in a stable location.** Hard disk drives are particularly susceptible to shock and vibration. Make sure that you position your hard disk where it won't be bumped or moved while in use.
2. **Connect the SCSI device to your ESI** using a quality SCSI cable. Make sure that the connectors are firmly mated and that the wire "keepers" are locked in place.

NOTE: *There are two type of SCSI cables in common use: the 50-pin Centronics type and the 25-pin DB connector type. ESI uses the Centronics type connector. If your external SCSI device uses the DB connector you can use an adaptor cable to eliminate the mismatch.*

3. **Set the SCSI ID of your external SCSI device to any number other than 5 or 0.** (5 is the default ID of the ESI, 0 is used by the floppy drive). Consult the operation manual of your SCSI device for this procedure.
4. **Turn on the external SCSI device.**
5. **Apply power to the ESI.**
6. **Make sure the hard disk really is unformatted or contains information you no longer want.** Formatting a hard disk *erases all the data* on it. Press the Load button. If the display reads, "No Valid Drives" the drive isn't formatted. Continue on to step eight.
7. **Format the hard disk.** Press the Master/Global button, select Disk Utilities (7), then Format (6). The display should read, "FORMAT DISK". Use the Data Entry Control to select your hard disk, then press ENTER. The display asks, "Are You Sure?" Press the Inc/Yes button to confirm. Formatting takes a few minutes. Time to take a break.

Sampling Basics

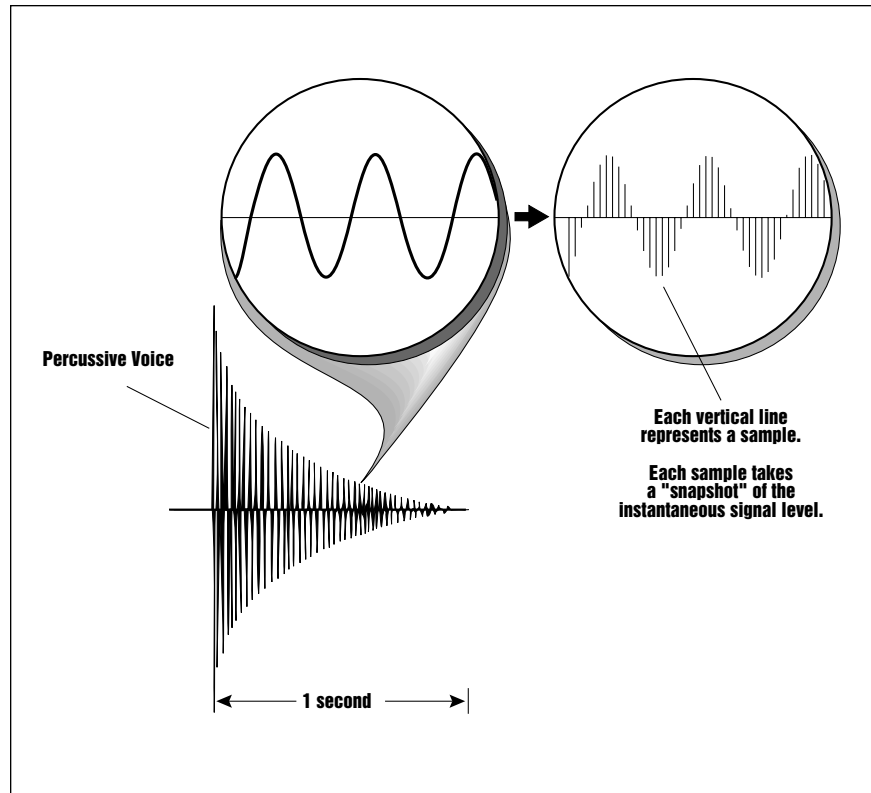

DIGITAL SAMPLING *The signal is repeatedly measured at a high rate and the measurements are stored in digital memory. Upon playback, the measurements are converted back into voltages to reconstruct the original waveform.*

Throughout this manual we will use the terms and concepts described and defined below. Read through this section carefully, even if you don't retain it all. You can refer back periodically as you read through the manual until you understand the basics and definitions.

The ESI is conceptually like a tape recorder. However, the recording process is very different since the ESI digitally records into its computer memory. Sounds for the ESI can be loaded via removable-media hard disk, magneto-optical disk, CD-ROM using the SCSI interface; or through the S/PDIF Digital interface; or even through the MIDI interface using MIDI Sample Dump.

Computers can accept information only in the form of numbers, so the ESI accepts audio signals coded into binary numbers. Samplers work by examining (sampling) the incoming signal level at a very high rate (44,100 times a second for compact discs), and sequentially recording these different levels in memory. Once stored, these samples may be played back (in the proper sequence, of course) to reconstruct the original signal. For instance, if a two-second sound was being sampled at 44.1 kHz, it would require (2 X 44,100) or 88,200 samples to be recorded. As you might imagine, shorter sounds require fewer samples.

A sound can be manipulated once it has been recorded. Playing back the samples in reverse order from which they were stored plays the sound backwards. Playing back the samples at a faster rate than the rate at which they were stored raises the pitch. Playing back at a slower rate lowers the pitch, much like a tape recorder's variable speed control.

Definitions

How the ESI Organizes Sounds

Sure, you're anxious to start coaxing wonderful sounds from the instrument—but the following is a necessary part of learning how to play the ESI. It is important to understand how the ESI organizes sounds in order to make best use of the instrument in the shortest possible time. Many terms will be introduced now that show up later in the manual.

You can think of the ESI as resembling a collection of sound-organizing modules, all contained within an the ESI bank. Pathways indicate how information flows within the ESI. Let's take a closer look at what makes up this information, and how it is transferred from one section of the instrument to another. We'll start with individual samples, then work our way through the system.

The Sample

Loading in any sound in mono or stereo creates a sample. A sample is the raw material with which the ESI works. The total available sampling time can be divided up any way you like—one long sample, lots of short samples, a few medium samples, or any combination thereof.

The term sample commonly means two different things:

1. A digital recording of a complete sound, or
2. Each snapshot of the sound that makes up the complete sample.
Confusing? You bet! In this manual, we'll assume sample means the complete recorded sound unless indicated otherwise.

You can modify a raw sample in several ways:

- **Transposition:** A sample can be transposed up or down in pitch to cover a particular range of the keyboard. By doing this, it is not necessary to record a sample for every key.
- **Digital Processing:** In the ESI, Digital Processing might consist of Looping a sample (allowing even short samples to play indefinitely), Truncating (cutting off unneeded parts of a sample, thus saving memory), or any of a number of digital processes that actually change the raw sample data.
- **Dynamic Processing:** Just as synthesizers include signal processors (filter, voltage-controlled amplifier, envelope generators, LFO, and so on) to modify the sounds produced by the synth's oscillators, the ESI includes similar modules for modifying the sound of samples or combinations of samples.

The Preset

As mentioned above, a sample can be assigned to a single note on the keyboard, or transposed polyphonically to cover a wider keyboard range. A **preset is one entire keyboard setup**. The process of assigning, and optionally transposing, samples to specific ranges of the keyboard is called making a preset. Making a preset is a three-step process:

1. **Create the preset and give it a number and name.** The bank can hold up to 256 Presets (000-255).
2. **Place samples to different keyboard ranges.** For example, with five samples you could assign each sample to cover one octave of a five octave keyboard. A sample can be assigned more than once within a given preset, and assigned to more than one preset.
3. **Choose from a number of available options that further define the preset.** Some examples are: assigning samples to partially or fully overlap other samples, thus producing doubling effects, or assigning dynamic control to individual samples in a preset. You can modify zone parameters, and set up MIDI and dynamic processing parameters.

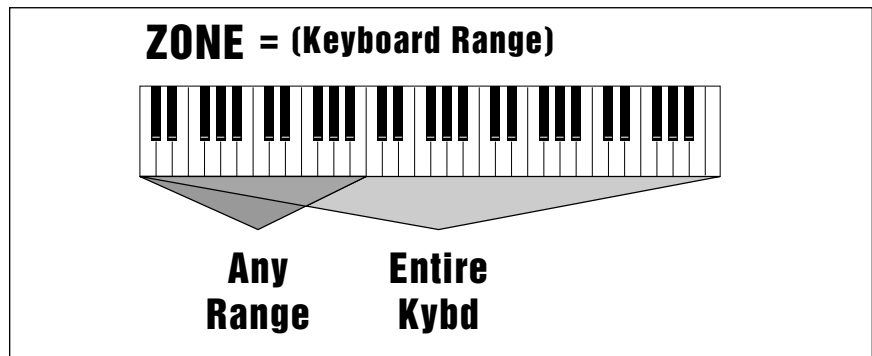

The Zone

A particular range of the keyboard is called a zone. This zone can include one or more samples and the zone's boundaries need not be the same as the boundaries of the samples contained in the zone. Zones free you from having to think about where the actual samples are assigned. You just select a range of keyboard (a zone) and go!

As an example, suppose you wanted to set the velocity response for the entire keyboard. You would first select the zone range by playing the lowest and highest keys when prompted by the ESI. Next you would set the velocity response (in the Dynamic Processing module). Done.

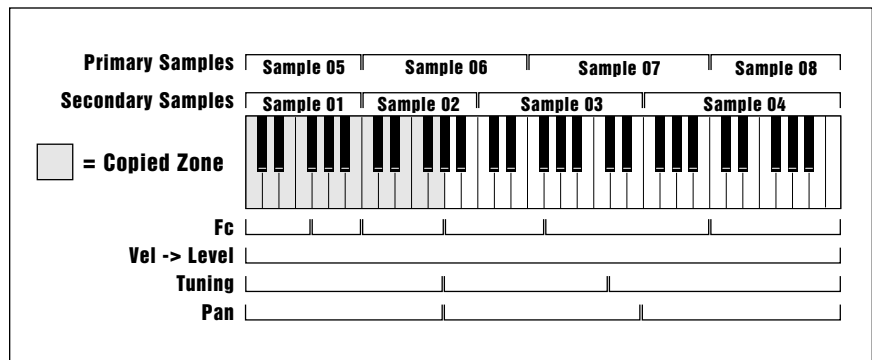

Now, suppose you wanted just the lower half of the keyboard to have increased velocity response. You would simply select a zone for the lower half of the keyboard, then change the velocity settings as desired.

When you copy a zone, the appropriate samples will be picked up along with the Dynamic Processing parameters.

The Bank

The memory bank contains samples, zones and presets. Everything. Consider the bank as the central storehouse for all of the ESI's data. Although the memory is volatile, meaning that the data disappears when you turn off power, all bank data can be saved permanently to the hard disk drive or other media to keep a record of your work.

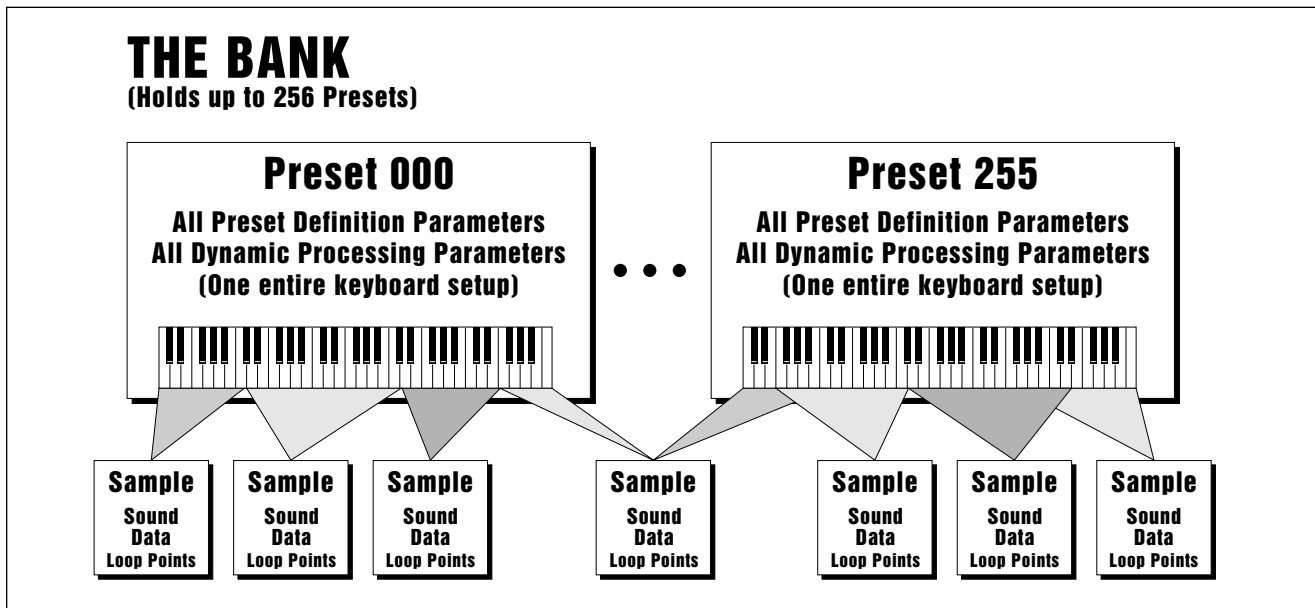

THE BANK All the data loaded into the ESI is called the **Bank**. Each individual keyboard setup is called a **Preset**. Individual **Samples** can be shared among presets.

The Internal Drive

A disk drive is a memory storage device that stores banks of data. The standard ESI has a built-in floppy disk drive which can be used to load and store bank data. However, other types of drives, as described later, can connect to the ESI to provide sound storage.

- **Floppy Disk Drive (Drive 0):** The floppy disk drive accommodates 3.5", double-sided, high-density (1.4 MB) floppy disks. The floppy drive on the ESI is used mainly as a convenient way to load and save small sound banks. When a bank size larger than 2 MB is used, (which requires 2 disks) the floppy disk becomes impractical for backing-up sound data.
- **Iomega 100 MB Zip Drive:** The ESI is also available with an internal 100 MB Zip removable disk drive in place of the floppy disk drive. Treat the internal Zip with care, just as you would any other hard disk drive. **To use:** simply insert a disk into the drive with the label side up.
To eject the disk: press the button on the right.

★ **Tip:** Use the "Mount Drives" utility (Master/Global, Disk Utilities, 1) whenever an external SCSI device does not appear in the list of available devices.

★ **Tip:** *The ESI can only load floppy disks which were created on the ESI. It can load hard disk data created on the EIII, EIIIX, Emax II or the Akai S1000/S1100.*

★ **Tip:** *Use the "Mount Drives" utility whenever an external SCSI device does not appear in the list of available devices.*

External Drives

The ESI has a SCSI (Small Computer Systems Interface) connector on the rear panel. This interface is commonly used in the computer industry, so that many devices made to work with computers—particularly mass storage devices—will also work with the ESI. Here are some of the types of mass storage devices that can plug into the ESI's SCSI connector.

- **Hard Disk Drive:** A hard disk provides the advantages of much higher memory capacity and far faster access time. Transferring data to and from the ESI is quite straightforward. However, you cannot remove a hard disk and replace it with another one—the disk is a permanent part of the drive. There are three main cautions involved with hard disks:
 1. Hard disks are sensitive to extreme mechanical shocks. If your hard disk falls off a keyboard stand, chances are the hard disk will be damaged.
 2. Make sure power is not interrupted when you write data to the hard disk.
 3. Hard disks have reached a very high level of reliability. However, they can fail from time to time (as can any part of a computer), so any data should be backed up periodically and regularly on some other medium.
- **Removable-media Hard Disk Drives:** These are similar to normal hard disk drives except that the disk itself can be removed and replaced with another disk. Disk densities can range from 44 Mbytes to over 270 Mbytes per platter. Removable-media hard disk drives allow you to build a sound library of unlimited size and are quite handy for transferring sounds between machines. They're also perfect for backups.
- **CD-ROM Drive:** A CD-ROM is a playback-only (data cannot be written to it) mass storage memory device whose capacity is approximately 660 Megabytes. Many high-quality and low cost CD-ROM libraries are available from several companies (E-mu Systems, Inc., Northstar, Sound Ideas, Q-Up Arts). These can be loaded into the bank as easily as you would load from a hard disk.
- **Magneto-Optical Drive:** Basically a read/writable CD, these high speed, high density storage devices are currently the hottest thing around for storing large amounts of sound data. Typically a magneto-optical drive can hold upwards of 300 Mb per side and the removable cartridges can be used over and over. Disk access time is comparable to a normal hard disk, and is sometimes even faster!
Advantages: High-speed, high-density, reliable, removable.
Disadvantage: High cost (although prices are dropping fast).

Additional Definitions

The Primary and Secondary Layers

An ESI key provides for two channels. These contain the primary and secondary layers. For example, the primary layer might be a sample of a guitar note and the secondary layer a detuned version of the same guitar note. When played together, you hear chorusing. Also, a preset contains information about how the keyboard dynamics affect the primary and secondary layers. As an example, the primary layer could be a sample of a drum hit played softly, and the secondary of a drum hit played loudly. Thus, playing the keyboard softly would play the primary layer, and playing the keyboard more forcefully would play the secondary layer.

The Current Preset

When you load a bank, a preset will be ready to play and the display will show the preset number. This is the current preset. If you select another preset, or create a preset, that will become the current preset.

The Current Sample

When a bank is first loaded, the current sample defaults to Sample 001. Whenever you record, load, or select a sample, it becomes the current sample. Thereafter, when you load a bank, the default sample is the current sample at the time you last saved that bank. For example, if sample 029 was the current sample the last time you saved the bank, then the next time you load the bank the current sample defaults to sample 029. You can always hear the current sample by pressing the audition button or entering the Digital Processing module.

Modules

A module controls a particular set of functions in the ESI. There are six main modules: Master/Global, Preset Management, Preset Definition, Sample Management, Digital Processing and Dynamic Processing.

★ **Tip:** *If a module is already active and you are finished with one submodule, you do not need to re-activate the module - just key in the new submodule number.*

- **Activating a Module and the Module Identifier:** To work with a module, you must first activate it. Press the button associated with the desired module. The display will then show the Module Identifier and invite you to select a submodule.
- **Submodule:** Each module contains several numbered submodules that set controls for additional functions. There are two ways to select a submodule within the module. You can move the Data Entry Control until the display shows the desired submodule, then press ENTER. As you work with the ESI, though, you will start to memorize the submodule numbers and will probably find it faster to simply key in the appropriate submodule number using the numeric keypad. When using the keypad, it is not necessary to press ENTER. Pressing either the module button or the Escape button will return you to the preset selection screen.

Saving

The bank only retains data for as long as the ESI is plugged in and turned on. Of course, we don't expect you to leave the thing on all the time, which brings us to the subject of saving data.

Pressing the SAVE button on the Control Panel shuttles all the bank data (samples and presets) to the drive of your choice. A hard disk permanently stores data so that even after turning off the ESI, the disk will contain a record of your work.

IF YOU DO NOT SAVE A BANK, ALL BANK DATA WILL BE LOST WHEN YOU TURN OFF THE MACHINE.

Do not wait until the end of a session to save. Save your work periodically in case of power failure or some other unforeseen circumstance that might erase the bank's memory. Floppy disks and hard disks are not infallible. All hard disk banks should be backed up periodically to another hard disk or other media. Should you improve the preset or sample later, you can always replace the original with the revised version. And if something goes wrong, the original will still be available to save you the ordeal of starting from scratch. Whenever you have done enough work that you would hate to lose it, back it up!

Since the disk contains a record of the bank data, loading the disk back into the bank transfers all the sample and preset data into the bank. This will replace the existing bank data, if any.

Default

A default setting is what we've judged to be a useful initial setting, and remains in effect until you change it. For example, if you create a new preset, portamento will default to 0 seconds (off). Had it defaulted to some higher value, all new presets would have portamento applied.

The Cursor

The cursor is that small flashing line on the display. It sits under the number or letter that will be altered if you enter data. Entering a new value will overwrite the number or letter above the cursor, whereupon the cursor will move on to the next number or letter (if applicable). If the ESI is expecting a two or three-digit number, in most cases you must enter all the required digits even if some of these are zeroes (called leading zeroes). For example, if the ESI is expecting a three-digit number and you want to enter 8, you would enter 008. If it is expecting a single-digit number, entering 8 would be sufficient.

Data Entry Control & Increment/Decrement Buttons

In virtually all instances where the Data Entry Control selects options, the Increment (INC/YES) and Decrement (DEC/NO) switches duplicate the Data Entry Control. Press INC/YES to increase a value, or DEC/NO to decrease.

Selecting

When the instructions say to select an option, you can use whatever method is most comfortable for you: the Data Entry Control, the Increment/Decrement buttons, the numeric keypad (if applicable) and, when naming, or selecting pitches, the keyboard keys. Some functions do not implement all these options; you can't go wrong by trying, though. If a function doesn't respond to the numeric keypad, for instance, then pressing the keypad will have no effect. Use the Data Entry Control or the INC/DEC buttons instead.

The Big Re-Cap

- A sample is a raw sound that is loaded into the bank.
- To create a new preset, make sure you have all the samples required for the preset in the bank, number and name a preset, then assign combinations of samples from the bank to specific sections of the keyboard. By specifying one or more of these samples (or portions thereof) as a zone, the zone may then be processed by the ESI's dynamic signal processors.
- After arranging a bank, it can be saved to one or more drives.
- Since loading from a hard disk fills the bank with samples and presets, you can group these samples into new presets, process the samples contained in particular zones, or alter existing presets.

2

Controls

Master Volume	21
Data Entry Control	21
INC/DEC Buttons	21
Ten Key Pad	21
Escape	21
Enter	21
Cursor/Page	22
Preset Selection	22
Load Bank	23
Save Bank	23
Drive Select	24
Audition	24
Trigger Mode	24
Multimode	25
Transpose	25

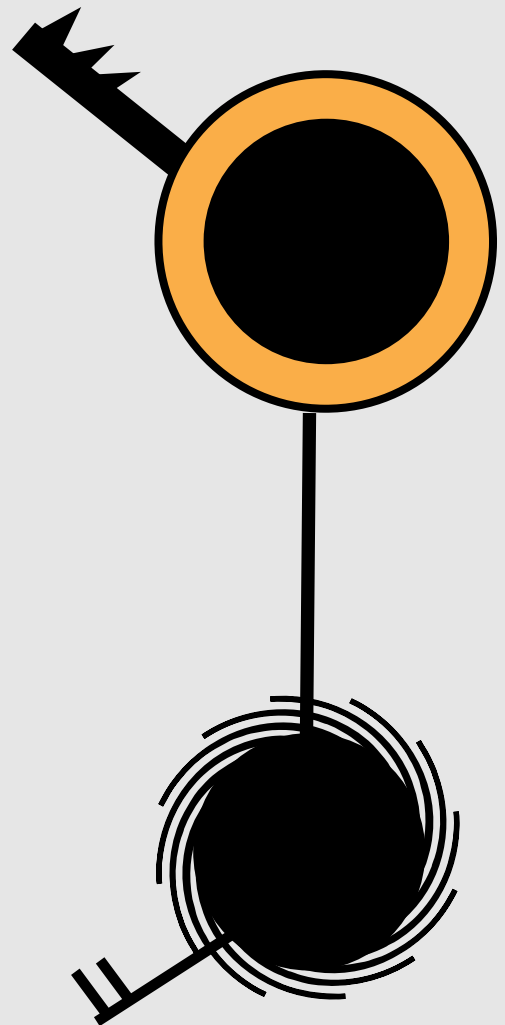

Master Volume

The Master Volume Knob controls the volume of every audio output on the ESI including the submix and headphone outputs. The master volume knob is a digital control. For maximum dynamic range it should be kept near the maximum position.

Data Entry Control

Using the Data Entry Control is the most common way to change parameter values on the ESI. Moving the control changes either the data over the flashing cursor or scrolls through options in the display.

Inc/Dec Buttons

In all ESI menus where the data entry control selects options, the Increment (INC/YES) and Decrement (DEC/NO) Buttons duplicate the function of the Data Entry Control. The increment/decrement buttons can be used when a finer degree of control is required. They can also be used for selecting Yes or No.

Ten Key Pad

The Ten Key Pad is used to enter data in precise amounts. For instance, if you wanted to jump to preset 10, enter 010 on the ten key pad and the new preset number will be instantly selected, eliminating the process of finding the number with the data entry control and then pressing Enter.

Escape

The Escape button lets you back out of a module by one menu each time the button is pressed. It can also be used anytime you do not want to execute a particular function (bail out). In the Sample Management module, pressing the Escape button terminates the sampling process.

Enter

A flashing Enter LED means that the ESI wants you to do something. Data may need to be entered, or the ESI may be waiting for you to press the Enter button to activate a particular operation. If the Enter LED is lit steadily, pressing Enter is optional. Doing so will exit you from the function and return you to the module identifier. You also have the option of going directly to another function within the module.

Cursor/Page

The Cursor is a small flashing line that appears in the display window under the data that is currently being edited. The Cursor/Page buttons are used to move the cursor around in the display. The buttons are shaped like arrows which point in the direction of movement. In many cases a particular function will have more options than will fit on a single page of the display. In this case the right and left arrow buttons become the page selects, allowing you to move through the various pages of the display.

The Cursor/Page buttons perform the following functions:

- 1. Moving the cursor.** To move the flashing cursor line in a particular direction in order to select a different function, simply press the corresponding cursor key.
- 2. Selecting the display page.** In many submodules, a single screen of the LCD cannot display all the available parameters. Arrows (<- ->) in the display indicate that there are additional screens which may be viewed by pressing the corresponding cursor button.
- 3. Selecting presets.** When no modules are selected, and the cursor is placed under the preset number, presets may be incremented or decremented by pressing the left and right cursor buttons. This method is useful for live performance - arrange your presets in the desired order, and step through them as needed.
- 4. Adding or deleting a space when naming.** A quick and easy way to add or delete a space when naming samples or presets is to use the left and right cursor keys. The up key adds a space and the down key deletes a space.
- 5. Selecting zero crossing points when editing samples.** When editing samples in the Digital Processing module, the left and right cursor buttons can be used to select points where the waveform crosses the zero axis.

★ **Tip:** *The cursor buttons can be used to select presets only when the ESI is in Omni or Poly modes.*

Preset Selection

Selecting the Current Preset

With no modules active, the display shows the **Current Preset** name and number on line 1 of the display. The blinking cursor appears under the preset number's first digit. There are five ways to change the current preset:

- 1. Enter a three-digit number with the keypad.** If you enter a number for which there is no preset, the lower display line shows the illegal preset number and says "Empty Preset." Try again.
- 2. Move the data entry control or the increment buttons.** The top display line continues to show the current preset, but the lower line will scroll through the available presets as you move the data entry control. When the lower line shows the preset that you want as the current preset, press ENTER.
- 3. Increment or decrement the Current Preset** (as displayed in the top line) with the left and right cursor buttons. This method is useful for live performance—arrange your presets in the desired order, and step through them as needed.

4. Use a MIDI footswitch to advance through the presets.
5. Use a MIDI program change command. Presets 000-127 can be accessed via a MIDI program change command. Presets 128-255 can be accessed using a MIDI bank select command, followed by a program change. *See the MIDI Implementation Chart in the Appendix.*

To see the current preset number at any time, de-activate any active module and look at the display.

Load Bank

A bank consists of presets and samples. The Load function loads this data into the ESI's memory bank from the floppy disk, hard disk or other external SCSI device.

1. Press Load.
2. If necessary, select the drive containing the bank to be loaded. The ESI defaults to the current drive. If you want to choose a different drive, place the cursor under the drive number in line two, select the appropriate drive and press ENTER.

LOAD BANK from
D1 Internal HD

Select a Bank

3. Select the bank number that contains the bank to be loaded, then press ENTER. The display will say: Loading Bank. After a few seconds, the bank will be loaded. The display will revert to the preset selection screen.

Save Bank

A bank consists of presets and samples. The Save function saves this data from the ESI's memory bank to the floppy disk, hard disk or other external SCSI device.

1. Press Save.
2. If necessary, select the drive to which the bank will be saved. The ESI saves the bank to the current drive by default. If you want to choose a different drive, place the cursor under the drive number in line two, select the appropriate drive and press ENTER.

SAVE BANK into
D1 Internal HD

Select a Drive

3. Select the number to which the bank will be saved, then press ENTER. The approximate size of the bank will be displayed on line four. Empty banks are indicated as such, along with their bank number on line three. Or, you can overwrite an existing bank.

SAVE BANK into
D1 Internal HD
B00 Stereo Grand
7.8MB in Bank

4. Press **ENTER** to save the bank. A bar graph appears in the display showing the progress of the save operation. The display reverts to the preset selection screen when the save operation is completed.

Drive Select

Use the Drive Select Button to select which storage device to use when loading or saving. The ESI may have an internal hard disk and/or several external SCSI devices connected.

1. Press **Drive Select**. The display shows:

DRIVE SELECT
D1 Sony SMO-C501

Select a Drive

! Caution: All SCSI devices are listed in the drive select screen, such as a computer or another sampler on the SCSI bus. Please note that only SCSI storage devices can be selected.

2. Use the **Data Entry Control** or **10 Key Pad** to select the desired drive, then press **ENTER**. Any subsequent Load or Save operations will now use the selected drive.

Audition

The Audition button allows you to play the currently selected sample, at its original pitch, directly from the front panel without having to connect a keyboard or other controller. (The current sample is selected in the Digital Processing module.) When you are in the Load Sample submodule, the Audition button allows you to preview samples directly off the hard disk without having to first load them.

Note: If you are auditioning from the current RAM bank you hear the audition in stereo. If you are auditioning from the disk, you hear the audition in mono.

Trigger Mode

When Trigger Mode is activated, the buttons of the ten key pad become sound trigger buttons which can access any ten notes in the current preset. This allows the ESI to be used as a stand-alone sample playback unit. In Trigger Mode, the LED next to the trigger button illuminates and all ESI functions operate normally, except that the ten key pad is now used exclusively for triggering sounds.

The Trigger Buttons are programmed in the Master/Global module, Special (8), Trigger Buttons (7).

Multimode

The Multimode Button puts the ESI into Multimode, where it can receive on up to 16 MIDI channels at once. Multimode is used for multi-timbral sequencing and when using a keyboard that can transmit on more than one MIDI channel at a time. The Multimode screen is where you assign presets to MIDI channels for multi-timbral sequencing. You can also set the volume and stereo pan position for each channel's preset.

1. Press **Multimode**. The display shows:

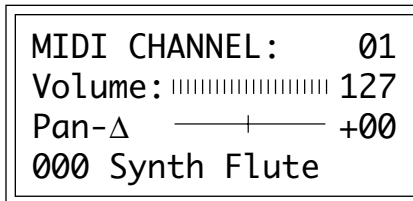

2. Use the cursor buttons to select one of the following parameters to edit. The volume, pan and preset can be programmed for each of the 16 MIDI channels. Use the data entry control or INC/DEC buttons to change the MIDI channel, Volume or Pan setting. If you do not want the ESI to respond to certain MIDI channels, set the preset for those channels to “Unassigned” which is located just below preset 000.

★ **Tip:** Setting the preset to “Unassigned” also blocks incoming preset changes on that channel.

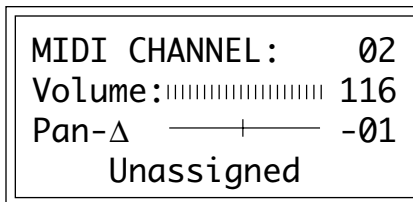

Transpose

This function transposes the entire ESI in half-step intervals up to \pm one octave. When in multimode, all channels will be transposed. When the ESI is in Transpose mode, the Transpose LED will be lit steadily. A new transposition can be selected at any time, regardless of whether or not the Transpose LED is lit.

Some applications are:

- Use one key's fingerings in a different key. Modulate to a different key without having to use different fingerings.
- Use transpose to easily reach hidden zones that lie beyond the ends of the physical keyboard.

1. Press and hold **Transpose**. Its LED flashes, and the display shows:

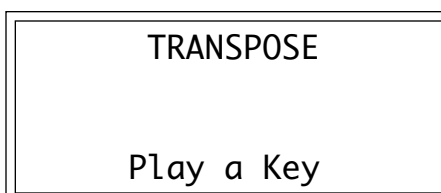

2. While holding Transpose, select the desired transposition interval. All transpositions are referenced to C2, the second C from the left hand side of the keyboard.

Some examples are:

- **To transpose down one octave, press C1.**
- **To transpose up one octave, press C3.**
- **To transpose up a fourth, press F2.**

Note that pressing keys C#3-C4, C#4-C5, or C#5-C6 will, in each case, produce the same effect as pressing keys C#2-C3.

3. While holding Transpose, check the display to confirm the transposition interval. Upward transpositions are indicated with a + symbol, downward transpositions with a - symbol. For example, if the ESI is transposed up a fifth, the display will show:

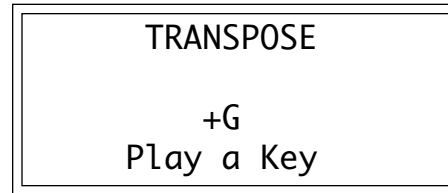

- 4. Release Transpose to retain the transposition.** The Transpose LED stays lit to remind you that the ESI is transposed.
- 5. To cancel the transposition, press and hold Transpose and press C2.** Display line three will go blank. Release Transpose and the LED should now be off.

3

Guided Tours

1. Basics	29
2. Selecting Zones	33
3. Dynamic Processing	35
4. Realtime Controls	42
5. Sampling	45
6. Digital Processing	47
7. Managing the Bank	54
8. On Your Own	54

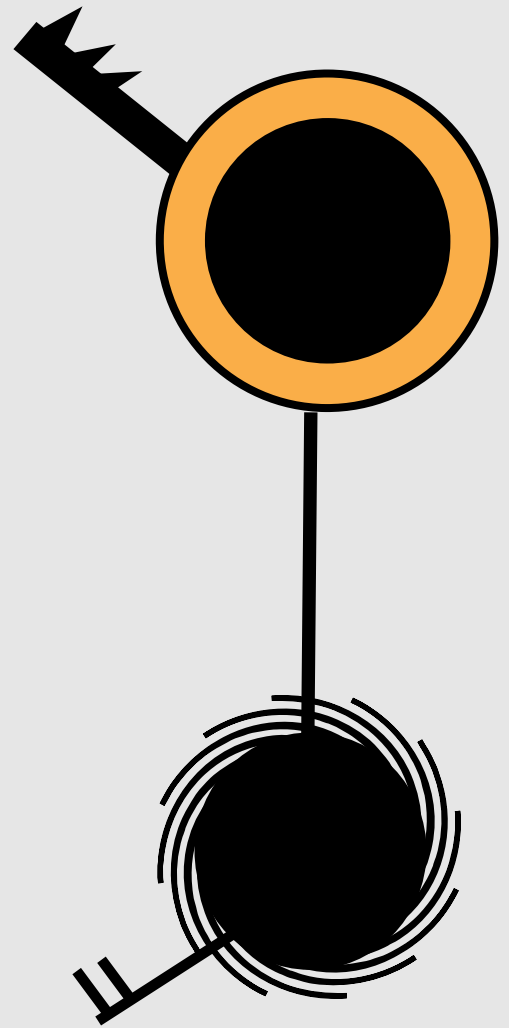

Tour 1:

The Basics

Welcome to the Guided Tours! If you have just met the ESI for the first time, we suggest that you follow these tours until you complete the Guided Tours section. This will get you up and running on the ESI in the fastest possible time. Also, you'll learn some tricks in this section that will come in handy as you play and become more familiar with the ESI. This tour covers how to:

- **Load and Save to Floppy Disks**
- **Select Different Presets within the Bank**
- **Tune the ESI to Other Instruments**
- **Transpose the Keyboard**

Loading a Bank from Floppy Disks

1. **Press the Load button.** Position the cursor under the drive number in line two. Select the floppy drive using the Data Entry Control.
2. **Insert the first floppy disk of the selected bank and press ENTER.** The display will say: Loading Bank. Remember that loading in a new bank erases the currently loaded bank, so always think twice before pressing ENTER to load the bank. (Since ESI banks can be quite large, it may require several floppy disks to hold an entire bank. Multiple floppy disks must be inserted in the proper order. That's why it's a good idea to label them numerically.)

Play the sounds from the newly loaded disks.

★ **Tip:** *ESI banks usually do not fit on a single floppy disk. To load multiple disk banks, insert the first disk, then replace it with the next disk when prompted by the ESI.*

Saving Data to a Floppy Disk

The floppy disk drive can be used to make permanent backups of your work. This can be a time consuming process, especially with large bank sizes and is best handled using a hard disk. If you do not have a hard disk installed in, or connected to your ESI, you can back up your work to floppies. In preparation, you should try to have at least five ESI formatted, double-sided, high-density, 3.5" diskettes on hand.

To Format a Floppy Disk:

Before a floppy disk can be used by the ESI, it must be formatted using the Format Disk function.

1. **Activate the Master/Global module.**
2. **Select Disk Utilities (7), Format Disk (6).**
3. **Select the floppy using the data entry control and press ENTER.** Position the cursor under the drive number in line two. The ESI will normally default to the floppy drive.
4. **Insert a floppy disk into the drive and press Yes to format.** Formatting a disk will erase all information on the disk.

Once the format is complete, the ESI asks if you want to format another disk. **Continue to format at least four more disks**

5. The display asks, "Format Another?" **Insert the next disk and press Yes** to continue formatting. After formatting the last disk, press **No**.

Saving Data to a Floppy Disk:

1. **Press the Save button. Position the cursor under the drive number in line two.** Select the floppy drive using the Data Entry Control.
2. **Insert a floppy disk and press ENTER.** The display will say, "Saving Bank". If the save requires multiple disks, the display prompts you to insert the next disk. Once the save operation is completed, the display returns to the main screen. If the save required multiple disks, make sure to label them numerically.

Using an External Hard Disk

You may connect an external hard disk, to load and save data, to the ESI external SCSI port. Before connecting any SCSI device, always make sure that power to the ESI and the external SCSI device is turned Off.

To Connect an External Hard Disk Drive

1. Turn all power Off to the ESI and the external drive.
2. **Connect the external drive to the ESI using the proper type of SCSI cable.** This will most likely be a 50-pin, male to male Centronics type. (Please read the SCSI section in this manual for important information on SCSI connections.)
3. Turn on the external SCSI device **BEFORE** the ESI.
4. Turn on the ESI.

To Format a Hard Disk Drive

Like a floppy disk, a hard disk must also be formatted before it can be used to store information.

1. **Activate the Master/Global module.**
2. **Select Disk Utilities (7), Format Disk (6).**
3. **Select the hard disk using the data entry control and press ENTER.** Your hard disk should appear in the list of available drives. If the hard disk is not listed, use Disk Utilities, 1 to Mount Drive. After Mounting, the hard disk should appear in the list of available drives. If it does not appear, turn everything Off, then read the SCSI chapter in this manual for possible solutions.
4. **Consider the consequences of your action.** Formatting the hard disk will erase everything on that disk. The display will inquire if you want to do this.
5. **Press Yes to continue the formatting procedure or No to cancel the operation and return to the Module Identifier.** Formatting a hard disk can take quite some time, depending on the size of the disk. Take a break.

Saving Data to a Hard Disk

The hard disk drive is used to make permanent backups of your work. Although you can back up your work to floppy disks, the capacity of the floppy drive is too small to be efficient. Only the hard disk (or its equivalent) should be used for sound storage.

To Save a Bank to Disk:

1. Press the Save button. Position the cursor under the drive number in line two. Select the disk drive using the data entry control. Press ENTER.
2. Use the Data entry control to select an Empty Bank. Empty banks are indicated as such, along with their bank number on line three. Saving to a non-empty bank erases the bank that was previously saved there.
3. Press ENTER to save the bank. The display will revert to the preset selection screen.

Loading a Bank from a Hard Disk

1. Press the Load button. The display says: Load Bank, and shows the name and number of the current bank.
2. Select the desired bank. Use the Data Entry Control to scroll through the available hard disk banks. Stop when you find the bank you want.
3. Press ENTER.
 - An alternate method of loading a hard disk bank is to press Load, then type in the number of the bank using the numeric keypad. The display will show the current preset number and name. The cursor will flash underneath the first digit. Start playing the keyboard and adjust the master volume Data Entry Control for a comfortable listening level.

★ **Tip:** See *Master/Global, Disk Utilities* and the *SCSI* section of this manual for important information about hard disk drives.

To check out the various presets within the bank, read on.

Selecting Different Presets

The bank you just loaded contains several presets. To call up a new current preset, use the up/down cursor buttons to position the cursor under the preset number, then use the keypad underneath the display. Note that leading zeroes must be entered for preset numbers (for example, type 0, 0 and 2, not just 2, to call up preset 002). Now type the number of the desired preset on the keypad. The entered preset number these will replace the numbers indicated by the flashing cursor.

If you enter a number for which there is no preset, the display lists the entered preset number followed by “Empty Preset.” Try again.

To scroll through the presets available in the bank, turn the Data Entry Control. The various preset names will scroll on the lower display line. When this line shows the desired preset, press ENTER to make that the current preset. This is an alternative preset selection method.

Yet another method is to use the left and right cursor buttons to increment or decrement through the presets. This method allows you to arrange your presets in the proper order, then access them sequentially with a single press of a button.

When you're ready to check out some more sounds, proceed.

★ **Tip:** Use the “Mount Drives” utility (*Master/Global, Disk Utilities, 1*) whenever an external SCSI device does not appear in the list of available devices.

Tuning the ESI to Other Instruments

Select the Master/Globals module. Choose sub-module Master Tune (1). This function demonstrates how ESI uses the Data Entry Control to adjust a parameter. Play the keyboard while adjusting the Data Entry Control to change the overall tuning.

Transposing the Keyboard

Refer to the Transpose button. While holding the transpose button, play a key on the keyboard in the lower two octaves. The second C from the bottom (C2) corresponds to normal or no transposition. All transpositions are based from this C2 key. For example, pressing the G key above C2 will transpose the keyboard up a perfect fifth. If the keyboard has been transposed, the transpose LED will stay lit. Press and hold the transpose button while pressing C2 to return to normal transposition.

Tour 2: Selecting Zones

The Current Sample & Current Zone

The ESI has two modules dedicated exclusively to processing samples within a preset: Sample Management and Digital Processing. Each sample stored in a bank can be processed by the Digital Processing module independently. Therefore, we need a way to specify the current sample, which is the individual sample to be processed.

The concept of the current sample is important. To process one sample out of a preset, select **one** sample to be the current sample, and process it.

To Identify Which Keyboard Keys Belong to Which Sample:

1. Activate the Preset Definition module.
2. Select Edit Assignment (2).

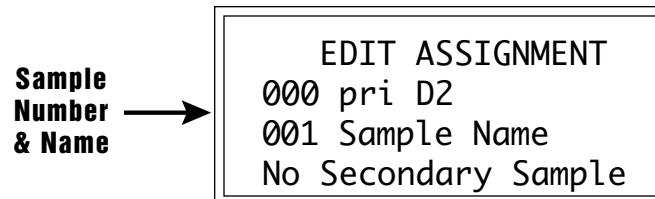

3. **Play a key on the keyboard.** Line two shows the preset number and the last key pressed. Line three shows the primary sample assigned to the key, and the fourth line shows the secondary sample, if any, assigned to the key. As you run your fingers up and down the keyboard, the primary and or secondary sample numbers will change indicating the keyboard range of those samples. You can also move the Data Entry control knob to show you the sample boundaries.
4. **Choose a zone and press ENTER.** The display now shows the range of the current zone on the upper line of the display. Don't play any keys but press ENTER again. Now the display shows something like this, where XX is the name of the key (such as D2).

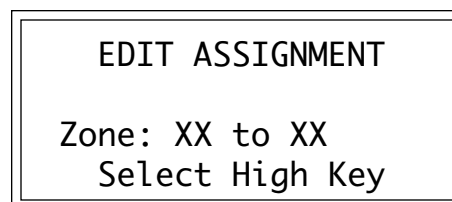

Specifying the Zone of the Dynamic Processing Module

Zones are sections of the keyboard which can be selected to apply Dynamic Processing parameters or to be copied, erased or loaded from another preset. A copied zone contains samples as well as dynamic parameters. A zone can be one key or the entire keyboard range.

Now that we know how many samples there are in the preset, and the range covered by each sample, let's specify a range of keys (defined as a "zone") to be altered by the Dynamic Processing Module. Refer to Tour 3, Dynamic Processing for information about dynamic processing. This section describes how to specify a zone to be affected, starting with the lowest key.

1. **Activate the Dynamic Processing module.**
2. **Choose Select Zone (0).**
3. **Specify the range of the zone.** The display instructs you to "Select Low Key." Press the lowest key on the keyboard, then press the ENTER button (whose LED is now flashing). The display then instructs you to "Select High Key". Press a key on the keyboard near the top of the keyboard, then press ENTER. The display now shows the current zone and prompts you to "Select a Submodule".

At this point, you can begin modifying the sounds in the bank with the Dynamic Processing module. The assigned current zone will remain as is until you either change the current zone assignment, change presets, or load another bank. If you switch between modules, the current zone remains as assigned (unless you select the Digital Processing Module, which will be a subject of a later tour).

Before proceeding, look over Dynamic Processing, 0. Select Zone to help reinforce what you've learned. Now that you know what a zone is and how to specify it, we've reached the end of this tour. Feel free to come back any time to refresh your memory. In the next tour, we'll see how to modify samples with the Dynamic Processing section.

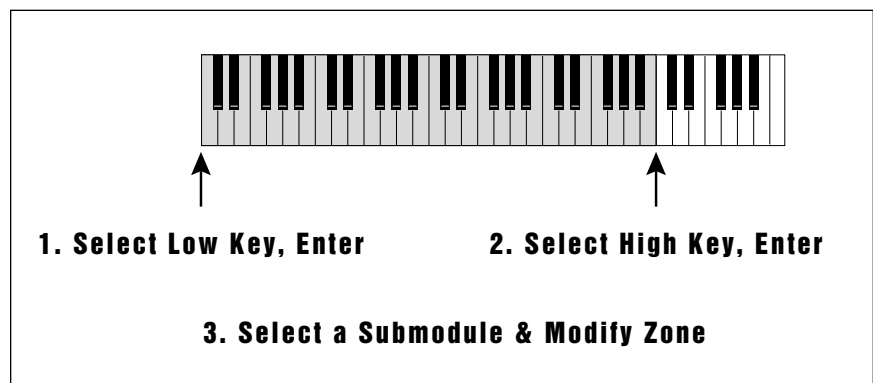

Any range of the keyboard can be a zone. Select the low and high keys which define the zone, then select the Dynamic Processing parameter to be modified.

Tour 3:

Dynamic Processing

The Dynamic Processing module consists of several interesting sound processing functions. Let's start with the Filter and VCA sections, as they are among the most important.

The VCA function contains a Voltage Controlled Amplifier that controls the amplitude envelope of a sound. The filter function contains a Voltage Controlled Filter that controls the timbre of a sound. (Note: The voltage controlled filters and amplifiers are actually implemented digitally.)

Working with the Filter

A filter is a device which allows you to remove certain components of a sound depending on its frequency. For example, a Low Pass Filter, like the one in ESI, lets the **low frequencies pass** and removes only the high frequencies.

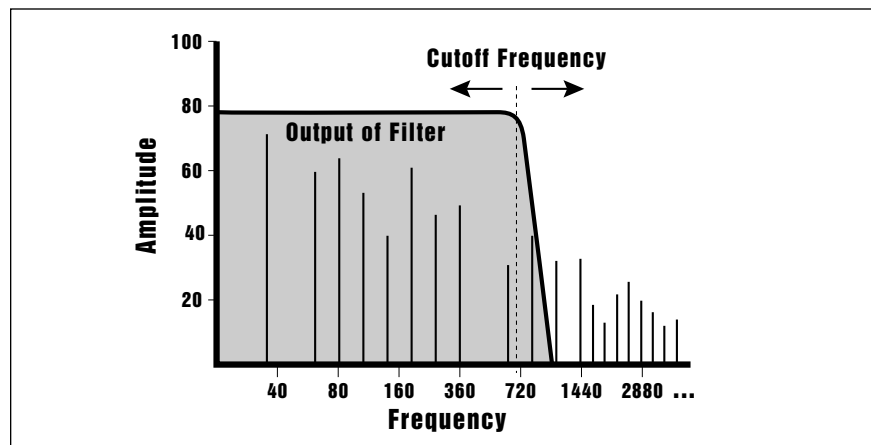

★ **Tip:** When the filter cutoff is set to 0 Hz, the sound will be completely cut off. The initial filter cutoff and all filter Fc modulators ADD algebraically to determine the actual Fc. If you are not getting sound, adjust the initial Fc or reduce the amount of modulation. Careful adjustment of the filter parameters is the secret of getting great sounds.

The point at which the frequencies begin to be cut is called the Cutoff Frequency (or Fc for short). A filter that lets only the high frequencies pass would be called a High Pass filter. Using a filter, we now have a way to control the harmonic content of a sampled sound. As it turns out, a low pass filter can simulate the response of many natural sounds.

For example, when a piano string is struck by its hammer, there are initially a lot of high frequencies present. If the same note is played softer, there will be fewer of the high frequencies generated by the string. We can simulate this effect by routing the velocity of the keyboard to control the amount of high frequencies that the low pass filter lets through. The result is expressive, natural control over the sound.

The VCF envelope generator is used to control the cutoff frequency of the low pass filter. This allows the frequency content to be varied dynamically over the course of the note. Dynamic filtering coupled with different samples makes for endless possibilities in the final sound.

Another control on the low pass filter is called Q or resonance. Turning up the Q of the filter tends to emphasize the frequencies around the cutoff frequency. In terms of sound, frequencies around the cutoff will tend to “ring” with high Q settings. If the filter is swept back and forth slowly with a high Q, various overtones will be “picked out” of the sound and amplified as the resonant peak sweeps over them. Bells and gongs are real world examples of sounds which have a high Q.

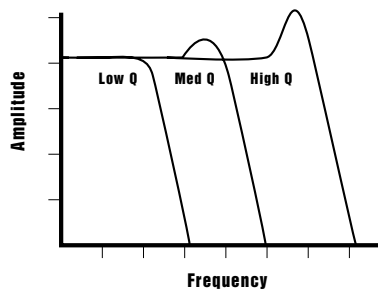

Turning up the “Q” will emphasize the frequencies around the cutoff point.

You could activate the Filter Setup function directly by keying in 3. However, let's investigate another way to select the filter function. Move the Data Entry Control to catalog the various Dynamic Processing functions. When the display shows function 3. VCF, press ENTER.

To Change the Filter Cutoff Frequency:

Increasing the cutoff frequency of a lowpass filter makes the sound brighter, decreasing the frequency makes the sound duller.

1. **Activate the Dynamic Processing module, select VCF (3), and select the 4 Pole Lowpass filter.** The display should look something like this:

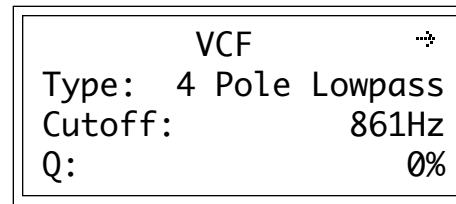

Play with the up and down cursor buttons. Note how you can move the cursor under the various parameters to be adjusted. For now, move the cursor under the Cutoff frequency on line three.

2. **Select the filter cutoff frequency.** To do this, vary the Data Entry Control. Note how the numbers to the right of cutoff change. Lower numbers mean a lower filter cutoff frequency (less high frequencies). Higher numbers mean a higher filter cutoff frequency (more high frequencies). Observe how only the notes within the current zone are affected by the Data Entry Control setting.

★ **Tip:** *Although we are changing the sounds in the bank, the sounds on the disk remain unchanged. This is because we haven't saved the bank to disk. You can fool around with the bank sounds as much as you want without having to worry about altering the original sounds on the disk.*

To Change Filter Q:

Increasing the Filter Q emphasizes the frequency at the cutoff point. See the diagram on the previous page.

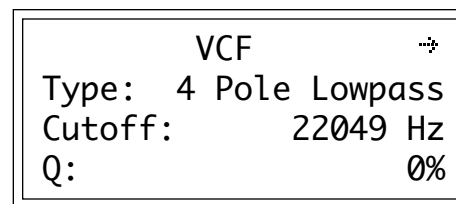

1. **Move the cursor to the Q% on line four. Vary the Q using the data entry control and note the sharpness of the sound changing.** Higher numbers give a sharper sound. Again, this affects only the range of notes covered by the current zone. In order to really hear the effect, set the Q at about 60 and proceed.
2. **Move the cursor back to Cutoff on line three. Vary the data entry control.** Note how this produces a sort of wa-wa effect. Remember, you have to re-trigger the key to hear the results of changing the Q.
3. **Set Cutoff to 200 Hz and Q to about 50.** The range of notes covered by the current zone should sound muted.

To Change the Filter Cutoff Envelope:

Enabling the envelope generator allows the envelope to control the cutoff frequency automatically.

1. Select page two by pressing the right cursor arrow.

⌂	VCF	⌂
Tracking:		+1.00
Envelope Amt:		+0%

Investigate the effects of envelope control over the filtered sound by moving the cursor to the Envelope Amount. Use the Data Entry Control to set a value of +40%. This allows the envelope to control the filter cutoff frequency.

2. Select page three by pressing the right cursor.

⌂	VCF Attack:	0.20s
Hold:		0.00s
Decay:		0.00s
Sus:99%	Rel:	0.40s

Move the cursor under the Attack time on line one and vary the Data Entry Control. With larger values, it will take more attack time for the filter frequency to go from lowest to highest cutoff frequency. Vary the various envelope parameters, and observe the effect these changes have on the sound.

To check out inverted envelopes, set the envelope parameters as follows:

⌂	VCF Attack:	0.20s
Hold:		0.00s
Decay:		0.00s
Sus:99%	Rel:	0.40s

Play and hold a chord. This is a non-inverting envelope in the sense that the envelope increases the filter cutoff frequency above the initial cutoff. To select an inverting envelope where the cutoff decreases below the initial cutoff, press the left cursor arrow.

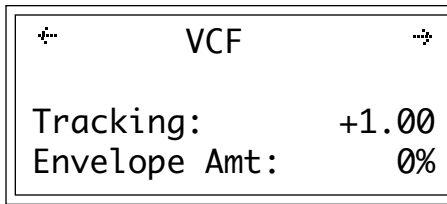

3. Move the cursor to Envelope Amount and select -40% to invert the envelope. The envelope effect is not all that noticeable when you play a chord. This is because the envelope forces the cutoff frequency in a negative direction. Since the cutoff frequency is already fairly low, it can't go that much lower. Now go back to the cutoff frequency and increase it. The effect will be far more noticeable since there will be more range available for the negative going envelope excursion.

If you feel like experimenting, play with the Tracking control to affect the way the filter frequency tracks the keyboard pitch.

4. Before proceeding with the tour, reset the filter parameters to their default settings. Set Cutoff Frequency to 22049, Q to 00, Envelope Amount to +00, and Tracking to 1.00. Set the Envelope Attack to 0.00s, Hold to 0.00s, Decay to 0.00s, Sustain to 100%, and Release to 0.49s. After entering these values, press ENTER to return to the Module Identifier.

Changing the Volume Envelope with the Voltage Controlled Amplifier



Piano

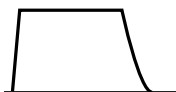

Organ

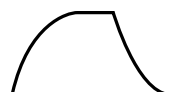

Strings

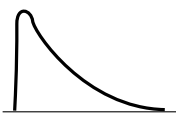

Percussion

The way the volume of a sound changes over time determines how we perceive that sound. For example, a bell struck with a hammer is instantly at full volume, then slowly dies away. A bowed violin sound fades in more slowly and dies away slowly. Using the VCA envelope generator, you can simulate different types of instrument volume envelopes by programming them appropriately.

In preparation for the following experiments, let's change the Current Zone to include the entire keyboard.

1. Select the Select Zone Submodule (0). Move the data entry control to the bottom of its travel and press ENTER. Now move the data entry control to the top of its travel and press ENTER again. You have now specified the entire keyboard as the current zone.
2. Select the VCA function (2). The display shows:

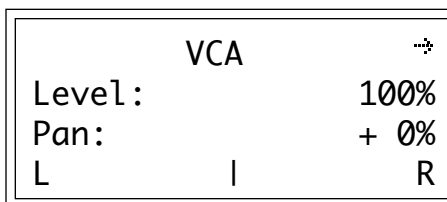

3. Select the next page of the VCA controls with the right cursor.

The generalized envelope shapes of a few types of sounds are shown above.

✦ VCA Attack:	0.20s
Hold:	0.00s
Decay:	0.30s
Sus:50%	Rel:0.60s

Move the cursor under the various envelope parameters and observe how different settings affect the sound. Before moving on, make sure you have a sound that is fairly sustained with little or no envelope attack time.

Other Dynamic Processing Options

1. **Select Dynamic Setup (1).** Note how the tuning, delay, and chorus controls affect the sound.
2. **Add some Low Frequency Oscillator effects. Select the LFO function (4).** The display shows:

✦	LFO	✦
Rate:	4.25Hz	
Shape:	triangle	
Delay:	0.00s	

If the LFO rate is different, change the rate so that it is about 4.25 Hz.

3. **Use the right cursor/page button to move to the next page of the LFO controls.** The display will show something like this:

✦	LFO	✦
Variation:	0%	
LFO->Pitch:	0%	
LFO->Cutoff	0%	

Position the cursor under each display option. Vary the Data Entry Control and observe how this affects the sound. Adding LFO to Cutoff might not sound all that noticeable. If you want a more obvious effect, bounce back to function 3. VCF and set the Cutoff to about 200 Hz and Q to about 50. This should make the LFOs effect more noticeable.

4. **Select page three of the LFO controls.** The display will show:

✦	LFO	
	LFO->Pitch:	0%
	LFO->Cutoff	0%

If the LFO settings aren't to your liking, use the left cursor/page button to change the LFO rate, delay, and variation.

The Auxiliary Envelope

1. Select 5. Auxiliary Envelope. The display shows the first page:

	AUXILIARY ENVELOPE	✦
	Dest:	off
	Envelope Amt:	0%

Move the cursor under Destination on line two, and use the Data Entry Control to scroll through the auxiliary envelope destinations. Select Pitch as the destination, then set the Envelope Amount to -50%.

2. Select the next page using the right cursor. Set the parameters so that the display looks like this:

✦	AUX Attack:	0.00s
	Hold:	0.00s
	Decay:	0.40s
	Sus:0%	Rel:1.65s

Now play the keyboard. Since we are using an inverted envelope, notes will bend up to pitch and then hold there. This is an effect common in many natural sounds.

Vary the various envelope parameters, and observe the effect these changes have on the sound.

Understanding Velocity

Velocity parameters control the volume of a preset using the force of a keystroke. This section describes how to set the velocity.

By now you probably have a pretty messy sound as a result of all these exercises. Let's start with a clean slate.

1. Press the **Load Bank** button, then **ENTER** to re-load the bank. (Feed floppies as directed.)
2. When the bank is loaded, activate the **Dynamic Processing module**. You do not need to specify the current zone. ESI sets the entire keyboard as the current zone by default!
4. Select **Velocity To (6)**. The display will look something like this:

VELOCITY TO		↔
Pitch:	+ 0%	
VCA Level:	+ 0%	
VCA Attack:	+ 0%	

Moving on to the next velocity page we see:

↔	VELOCITY TO	↔
	VCF Cutoff:	+ 0%
	VCF Q:	+ 0%
	VCF Attack:	+ 0%

Moving on to the last velocity page we see:

↔	VELOCITY TO	
	Pan:	+ 0%
	Sample Start:	+ 0%
	Auxiliary Env:	+ 0%

★ **Tip:** Remember that the velocity-to-envelope Attack setting interacts with the initial envelope Attack settings. Call up the envelope Attack parameters for the filter and VCA and see how different values interact with different velocity values.

Move the Data Entry Control to select different values, and note the effects. With positive velocity sent to the VCA, the ESI plays softer as you play softer. In other words, the ESI equates harder play with the nominal volume setting and goes down from there as you play softer.

Continue to move the cursor to the other available parameters and vary the Data Entry Control. Notice that the filter cutoff frequency lowers as you play softer. The amount downward change is dependent on the value in the display.

Filter Q is affected differently than Level or Filter Cutoff. It raises from the initial setting as you play harder. Also, note that velocity can be set to affect Q inversely. In other words, if the filter is set to a high Q setting, playing harder on the keyboard will lower the Q.

Tour 4:

Realtime Control Programming

Ever wanted to add vibrato to a grand piano? Or bend its pitch? The Realtime Control functions in the Preset Definition module can do this, and lots more.

Pitch-Bending

First, let's check out pitch-bending. Pitch-bend can be enabled or disabled for any zone within a preset. Let's have pitch bend affect only the lower half of the keyboard. Activate Dynamic Processing, 0. Select Zone. Specify the upper half of the keyboard as the current zone.

Next key in Dynamic Processing, 8. Realtime Control Enable. Use the cursor/page buttons to see a list of modulation destinations. Pitch will be set to On. Press Off, and like magic, you can now pitch-bend only the lower half of the keyboard. If modulation does not seem to be affecting a zone, make sure that modulation is enabled.

Want to change the pitch bend range? Activate the Preset Definition module, select Pitch Bend Range (7).

Modulation Wheel Destinations

The ESI offers two modulation options: Pre-programmed, which adds a constant, selectable amount of modulation, and Realtime, where the player adds in modulation by using one of the wheels or other controllers.

Each wheel on your MIDI controller can be assigned to a particular destination. For example, if the left wheel is assigned to pitch, then rotating the wheel bends pitch. If assigned to the filter, rotating the wheel varies the cutoff frequency.

Let's set up for the next part of the tour. Choose preset 01 as the current preset if it is not already selected. Activate the Dynamic Processing module and assign the entire keyboard as the current zone if necessary. Select Realtime Enable (8). Use the cursor/page buttons to select On for all of the enable options. This will make it easier to hear the results of the next series of experiments.

Now activate the Preset Definition module, 0. Realtime Controls. To make "live" playing as simple as possible, the display works somewhat differently for this module. The display shows:

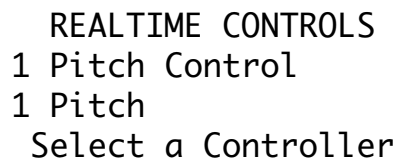

```
REALTIME CONTROLS
1 Pitch Control
1 Pitch
Select a Controller
```

Use the Data Entry Control to scroll through the available Realtime Control sources and their currently assigned destinations.

Control Sources

- | |
|--|
| 1: Pitch Control |
| 2: Mod Control |
| 3: Pressure Control |
| 4: Pedal Control |
| 5: MIDI A Control (can be assigned to any MIDI controller #) |
| 6: MIDI B Control (can be assigned to any MIDI controller #) |
| 7: Footswitch 1 (on your MIDI controller) |
| 8: Footswitch 2 (on your MIDI controller) |

Modulation Destinations

! Caution: Only one controller can be assigned to a destination. For example, if you assigned mod. control to VCF cutoff and then assigned pressure to VCF cutoff, the ESI would automatically turn off the mod. control to VCF cutoff routing.

- | | |
|------------------|-------------------|
| 0: Off | 6: LFO ->VCA |
| 1: Pitch | 7: Pan |
| 2: VCF Cutoff | 8: Attack |
| 3: VCA Level | 9: Crossfade |
| 4: LFO->Pitch | 10: VCF Note-On Q |
| 5: LFO -> Cutoff | |

Footswitch Destinations

- | | |
|-----------------|---------------------|
| 0: Off | 5: Unused 3 |
| 1: Sustain | 6: Unused A |
| 2: Cross/Switch | 7: Unused B |
| 3: Unused 1 | 8: Preset Increment |
| 4: Unused 2 | 9: Preset Decrement |

Each of the modulation destinations (0-10) can be controlled by control source via data sent over MIDI. Each of the footswitch destinations (0-9) can be controlled by sources 7 and 8. *Destinations 3-7 are from the EIII.*

You'll be happy to know that Realtime Control settings are memorized for each individual preset, so if desired, each preset can react to the Realtime controls and MIDI controllers in different ways.

Selecting a Control Source and Destination

1. Activate the Preset Definition module.
2. Select Realtime Controls (0).
3. Select Pitch Control as a control source. Move the cursor down to the next line. The display will direct you to "Select a Destination".

The left wheel should be assigned to 1: Pitch. Vary the wheel and check that the keyboard pitch is indeed affected. If sections of the keyboard are not affected, check that pitch control is enabled in the Dynamic Processing module, Realtime Enable (8) submodule.

Now try assigning the pitch control to 2: VCF Cutoff. Rotating the wheel towards you should produce a more muted sound.

If you feel adventurous, check out the other control destinations. Note that if you select a destination that is already specified for one of the other control sources, the old assignment will be de-selected and that control source will be turned off (0).

Think about it for a bit... the left wheel can control a destination, the right wheel can control a different one (as can a MIDI pedal). There are other MIDI control possibilities as well. These assignments can be different for each preset, and particular controller destinations can be disabled for different presets and samples. We're talking versatility here, so if you feel like taking the next couple of hours and checking out all the possibilities, by all means, do so!

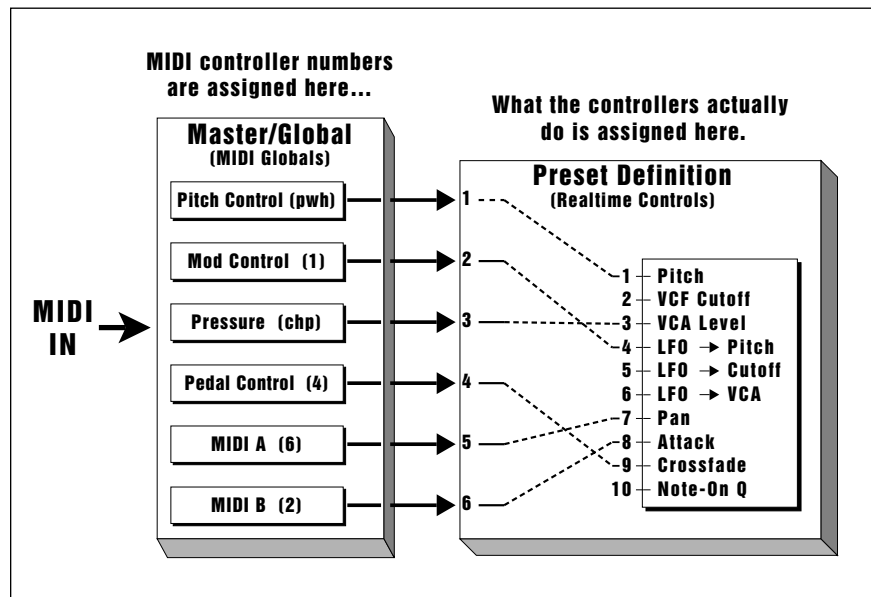

The Realtime Control screen is a digital patchbay where performance controls are routed to the various synthesizer parameters.

Oh yes, and there are footswitches too. But before experimenting with the footswitches (sources 7 and 8), we need to understand the difference between looped and unlooped sounds. Basically, a sustain looped sound is one where a portion of the sound is put into an infinite repeat loop for as long as you hold down the key. This is similar to the infinite repeat function on digital delay lines. Looping allows you to sustain a normally non-sustaining sound for as long as you like. An unlooped sound is not artificially sustained, and therefore lasts its normal length.

Keeping this in mind, refer to the Preset Definition module, 0. Realtime Controls, footswitch destinations 0-9. (Destinations 3-7 are EIII functions which were not implemented in the ESI. The numbers were retained to maintain compatibility.) Assign various functions to the footswitches. You will find that some sounds lend themselves to the sustain function better than other sounds, and we heartily encourage you to experiment.

Tour 5: Sampling

Sampling involves more than just sticking a microphone in front of something—sampling is an art. This guided tour gives you the basics, and also lays the groundwork for the guided tour of the Digital Processing Module. In preparation for this guided tour, please read section 5, Sample Management module.

Sampling

For this guided tour, simply connect a microphone (or another audio source such as a CD player) directly to either the left or right sample input.

1. **Activate the Master/Globals module.**
2. **Select 3. Erase Bank. Answer Yes to the display's query.** This clears out the memory, which gives us maximum sampling time.
3. **Activate the Sample Management Module, 5. Setup.** The display shows:

```
SETUP  AdcGain: -04 ↕  
Thresh: |  
L: on  |  
R: on  |
```

If you are sampling in mono, move the cursor to the input that you are not using and turn it off with the On/Off buttons. Otherwise, leave both channels on.

4. **Use the right cursor/page button to view the next page of the Setup section.**

```
↕  SAMPLE SETUP  ↕  
Source: analog 44100  
Length:      5.5secs  
200.8 secs Available
```

Check the available sampling time. This will vary depending on how much memory you have in your ESI.

5. **Change the source using the data entry control for analog sampling. Set the source to either Analog 22050 Hz or Analog 44100 Hz.**

6. Use the left cursor/page button to go back to the first page.

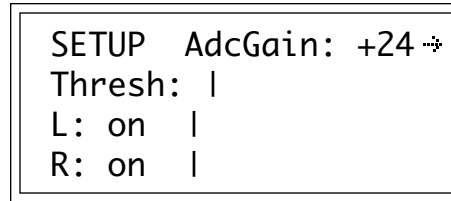

★ **Tip:** The optimum gain level setting for ESI is +00. For high-quality sampling, use an external microphone preamplifier such as the one built into your mixer. The mic preamp in the ESI, while acceptable for some applications, is not designed to be used for ultra-critical sampling.

Speaking into the microphone, you should see the VU meter move, indicating that the ESI is receiving signal. Place the cursor on line one of the display and use the Data Entry Control to adjust the input gain. Adjust the gain so that the peak bar comes close to the extreme right side without actually reaching it.

7. Go on to the third page of Sample Setup by pressing the right cursor button twice. The display shows:

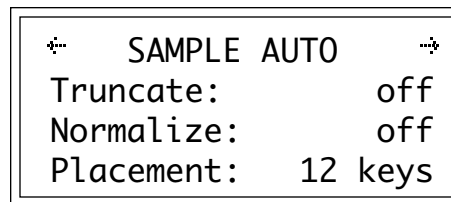

Set the automatic parameters as shown. The auto-placement parameter determines where the samples we are going to take will be automatically placed. In this case, with auto-placement set at 12 keys, the first sample will be placed on the lowest octave (C1 to B1), the next sample on the next octave up (C2 to B2), and so on.

8. Go back to the first page and set the Threshold using the data entry control. Set it up a few bars from the bottom so that the ambient room noise does not cause the ESI to trigger falsely. Press ENTER to return to the Module Identifier.

9. Select Arm Sampling (7). You're ready to sample! Speak into the microphone. As soon as the level exceeds the threshold, the display will say "Sampling." Chat away freely. If you run out of inspiration, press Escape to stop sampling.

! **Caution:** When sampling in stereo, the Threshold circuit only reads the left channel to initiate sampling.

More Sampling

Continue to experiment with sampling. Try setting a particular sample length, or using forced sampling instead of threshold-sensitive sampling, or assigning the sampled sound to other portions of the keyboard. Also, practice terminating the sampling process.

Let's try another sample. Notice that the ESI, will overwrite the existing sample unless you exit and re-enter the sample module. The new sample is automatically assigned to the next higher octave. This assignment can always be modified in the Sample Management module, 6. Place Sample.

Tour 6: Digital Processing

Saving the Sample

To save the sample as part of a preset, de-activate the Sample/Management module. Since memory was cleared prior to sampling, the ESI created a preset (00) called “Untitled Preset.” This is the preset that holds your new sample. Had you sampled into a bank with existing presets, the sample would have been stored with the current preset.

Remember, this guided tour is intended simply as an overview to give you a feel for the sampling process. Good sampling requires skill, patience, and above all, practice!

Background and Setup

Digital processing allows you loop samples stored in the bank. In this guided tour we’ll learn how to do this. First, though, we need to create a couple of samples with which we can practice.

1. **Clear the bank of memory. Use the Master/Globals module, 3. Erase Bank.**
2. **Make a sample of yourself speaking.** Following the directions in Guided Tour No. 5, select a four second sample length (Sample Management module, Setup). After setting the threshold and other parameters, arm sampling and start jabbering.
3. **Take another four second sample.** De-activate, then re-activate the module to sample. You will not have to do any setup — just hit 7. Arm Sampling, and talk away. You will then have two samples suitable for experimentation.
4. **Assign your samples to a keyboard zone.** Use 6. Place Sample.

Choosing the Current Sample

Activate the Digital Processing module. This module acts upon the current sample. To select another sample, press 0. Select Sample.

Truncating A Sample

Use the Digital Processing module, 3. Truncation, to truncate the ends off samples. Vary the Data Entry Control as you play a key in the range assigned to the current sample. Notice the start of the sample will disappear. Use this technique to get rid of silence at the start of a sample or for effects. Move the cursor using the up and down arrow keys to the End display. Use the Data Entry Control to truncate any undesired part from the end of the sample.

When you are satisfied with your truncating efforts, press ENTER. The ESI will automatically make a backup of the sample on the hard disk, (if you have one connected) in case you decide that you don’t like the truncation after all.

If desired, change the current sample (Digital Processing, 0. Select Sample) and experiment with truncating the other sample you took.

Looping A Sample

If you haven't yet done so, activate the Digital Processing Module and assign the current sample.

1. **Select 2. Loop to graphically see how looping affects a sample.** Since the loop function is on, if you play and hold a key in the current sample, it will play indefinitely.
2. **Try modifying the loop.** Adjust the Start and Length values. Note that if the length equals the full length of the sample, you will not be able to set a new start point. Reduce the length, and you should be able to adjust the start point. For practice, try looping individual words or sentence fragments.

A Practice Sampling Session

Plug a microphone into the rear panel left Sample Input jack (or through a DAT into the optional digital I/O).

1. **Erase all memory (Master/Globals, 3. Erase Bank).**
2. **Set the Sample Source for either Analog or Digital sampling (Sample Management, 5. Setup).** "Source" is located on the second page in the Setup submodule. If you are using the optional digital inputs, match the sample rate to that of your DAT recorder or the sample will play back at the wrong pitch.
3. **Set the level (Sample Management, 5. Setup).** Sing Ahhhh into the microphone. (This is an easy sound to loop.) The VU level should not quite reach the top of its range. Adjust the gain using the Data Entry Control, until a good level is attained.
4. **Set the threshold (Sample Management, 5. Setup).** This should be set about five or six bars from the left. When the input sound exceeds this level, recording will start.
5. **Select 7. Arm Sampling, to arm the sampling process.** OK, now get ready to sing Ahhhhh.
6. **Sing Ahhhhh!** When you are out of breath, press ESCAPE to stop sampling.
7. **Play the keyboard in the assigned range to hear the results.** The sound should default to the lower keyboard range, C1-B1. The original pitch of the sample should be located at G1.
8. **Truncate the silence off of the beginning and end of the sound.** Activate the Digital Processing module. The ESI will default to the only sample in the unit, which is the one you just made.
9. **Select 3, Truncation to enable the truncation function.** Adjust the start and end points by moving the Data Entry Control to remove any silence or unwanted portion of the sound. You must play the keyboard after you move the Data Entry Control in order to hear the results of the Data Entry Control change. Press ENTER to exit truncation.
10. **Activate the Digital Processing module, 2. Loop.** Now we are ready to loop the sound.

To loop, first move the Data Entry Control to make the loop length about half a second long. Next, move the start point into the sustained portion of the ahhh sound so that the ticking sound becomes softer. The idea is to loop the “hhh” portion of the “ahhh” but not the “a” part. The loop length can be adjusted so that it matches the rhythm or wavering of the sound. When you get a fairly good loop, press ENTER. The display says: “Auto Correlate? Y/N.” Press Yes. You now should have a fairly good loop. If not, adjust the start point and again Auto Correlate. It takes practice, but you’ll get it. That’s it! Feel free to play around with other digital and dynamic processors such as the filter, chorus and LFO.

Basically, these are the steps you will go through every time you have a sampling session:

- **Take the sample**
- **Truncate the sample**
- **Loop the sample, if desired**
- **Assign the sample to a keyboard position (Place Sample)**
- **Continue to refine and make presets**

Of course, you will probably develop your own order and style of sampling techniques. The purpose of this guided tour is to acquaint you with the concept of looping. There is much more to the subject than simply fooling around with looping words from a spoken sample. Please remember too that looping is a very complex process which requires a great deal of practice to achieve proficiency. The best way to fully understand looping is to experiment with a variety of signals.

Sample Placement

For sound effects or drums, try setting the Sample Auto Placement (Sample Management, 5) to white keys. This is a good way to keep your samples organized when doing rapid-fire sampling. Instead of using the Auto Sample Placement feature, you can set up your own placements before or after sampling. To place a sample, refer to Sample Management, 6. Place Sample.

- **Select the sample.**
- **Select primary or secondary layers.**
- **Select the original key.**
- **Select the low key of the range.**
- **Select the high key of the range.**

You can create a preset template by erasing the samples from a favorite preset, then saving the bank. As you take new samples, they will automatically be mapped onto the keyboard with Dynamic Processing parameters.

Time To Save?

Maybe you haven’t created any masterpieces during these experiments, but maybe you have. If you want to save a preset to disk, by all means do so.

More Magic...

Contestants, it's time to play, *The Backwards Talking Game!*

In preparation, first erase all memory (Master/Globals, Erase Bank), then take a sample of your voice speaking your name.

1. **Activate the Digital Processing Module.**
2. **Select Digital Tools I (7), Reverse (3).** The display shows:

REVERSE	secs	samples
Start:	0.00	00000
End:	1.62	35670
Size:	1.62	35670

3. **Press ENTER to reverse the sample.** The display defaults to the entire sample. Play the sample back. Hey, it's backwards! Now practice saying your name backwards until you feel that you have learned it well. Think you've got it, do you? OK, now sample yourself saying the reversed version of your name, and then of course..... reverse that! We guarantee loads of fun and maybe some surprising insights.

Cut and Paste

This exercise details how to cut portions out of a sample and paste it into another sample or even the same sample at a different location..

1. **Erase all memory using Master/Global, Erase Bank (3).**
2. **Take yet another sample of your voice.** Set the sample length to about 1.2 seconds. This time say, "Cut and Paste". Pronounce the words clearly and distinctly.
3. **Activate the Digital Processing module, Cut Region (5).** We are going to rearrange this sample phrase to say: Paste and Cut.
4. **Select the sample you just created.** Use the Data Entry Control to choose the sample, then press ENTER. The display shows:

CUT	secs	samples
Start:	0.00	00000
End:	1.00	44096
Size:	1.00	44096

The original pitch of the sample will appear on key C4, the fourth C up from the bottom.

5. **Move the cursor under End on line three.** Adjust the Data Entry Control so that only the word "cut" is heard. Press ENTER. The display will inform you that the ESI is backing up the sample, and then will return you to the module identifier.

6. **Select Paste Region (6).** Use the Data Entry Control to select the sample to which you want to paste. The display shows:

PASTE	secs	samples
Offset:	0.00	00000
Select Location		

Adjust the offset past that “t” sound of the word paste. Again use the left and right cursor keys once you get close. Press ENTER. The sample should now say, “and paste, cut”.

7. **Go back to Cut Region (5).** Cut out the word “and” using the same procedure you used for “cut”.

8. **Adjust the offset past the “t” sound of the word paste.**

9. **Back in Paste Region (6), use the left and right cursor keys to adjust the offset. Once you get close, press ENTER.** The sample should now say, “paste and cut”, although it might sound a little strange. That’s the basic technique. Practice makes perfect.

Now that you have gotten a feel for cut and paste, make up your own experiments using the various other options such as mixing and crossfading.

Gain Change & Taper

Sample your voice saying “Ahhh” for one second. This time when you sample, set the Gain so that the signal only reaches about halfway up the VU meter at its peak. Also make sure that the sample time runs out before you finish singing so that the sample is cut off prematurely. We’re intentionally creating problems so that we can fix them using Taper and Gain Change.

First, let’s boost the gain to full level using one of the digital tools, Gain Change. The term for this operation is called normalization. (Don't worry, it won't make you or your samples normal.)

1. **Activate the Digital Processing module.**

2. **Select Digital Tools I (7), Gain Change (2).** The display shows:

GAIN	secs	samples
Start:	0.00	00000
End:	1.00	44096
Size:	1.00	44096

We want to normalize the entire sample (which is already selected), so just press ENTER. The display now shows:

```

GAIN CHANGE

Amount:      +00dB
+XXdb = Normalize

```

Where XX is the amount of gain needed to achieve normalization or full level.

3. Set the amount of gain so that it matches the normalization reading. Press ENTER to accept the selection. The display shows:

```

FADE      secs  samples
Size:     1.00  44096
Type:                    Linear

```

4. We don't want a fade in this example, so simply press ENTER to affect the gain change.

The sample should now be at a higher volume. Note that you can use the Digital Processing module, Undo (9) to cancel the effects of Gain Change. Use this feature to further experiment with different Gain Change settings.

5. Select Taper (1). Now let's taper the end of the sample so that it smoothly fades out instead of ending in a thump. The display shows:

```

TAPER      secs  samples
Start:     0.00  00000
End:       1.00  44096
Size:      1.00  44096

```

6. Move the start point to about 0.70 seconds and press ENTER. The display changes to:

```

TAPER
Start Amount: 0.00db
End Amount:   -96db
Type:         Linear

```

The Start and End amounts on lines two and three are already at the correct settings. There will be no attenuation at the Start point, tapering to full attenuation at the End point of the sample.

7. Move the cursor to **Type** on line four. Select **Exp 2**, then press **ENTER**. The sample should now smoothly fade out instead of ending abruptly. And remember that Digital Processing, 9. Undo will cancel the effects of Taper. You can use this feature to further experiment with different Taper settings.

Pitch Change

Finally we're getting to the fun stuff! Pitch Change allows you to change the pitch of a sample without changing the time relationship between events.

1. Take a sample of your voice speaking... anything.
2. Activate the Digital Processing module.
3. Select Submodule 0, Select Sample. Since you may have multiple samples in memory at this point. Use the Select Sample function to pick the one you want to Pitch Change. Use the data entry knob to select the samples, then press **ENTER**. Each sample will be placed over the entire keyboard range.
4. Select Digital Tools II (8), Pitch Change (5). The display shows:

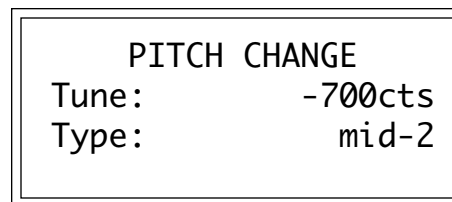

★ **Tip:** If you really want to mutate a sample, repeatedly tune the pitch up and down. Try the same thing using Time Compression.

Set the Tune control to about +700 cents (a perfect fifth up). Set the Type to mid-2. The pitch change Type is not critical, but mid-2 seems to work well for voice. Press Enter to begin the pitch change.

If you have a hard disk connected, the ESI will automatically back up your sample before processing it. If you don't like the resulting pitch change, press Digital Processing, Undo.

Tour 7: Managing the Bank

The following functions don't necessarily do terribly glamorous things, but they are exceedingly useful for managing your banks of sound data. This guided tour acquaints you with these utilities. To see how they work, load any bank from the hard disk.

Erasing A Preset

Activate the Preset Management module, 3. Erase Preset and erase preset 01. Don't worry, it will just be gone from the bank, not the disk. And we can get it back anyway by..

Loading A Preset

Refer again to the Preset Management module, 1. Load Preset. This time load preset 01. Now it's back in the bank again.

This is the basic method for creating a bank with presets from other banks. The bank can only be saved as a whole. Therefore, individual presets are loaded into the bank, and when the bank is arranged to your specifications, it is then saved to disk.

Other Bank Management Functions

The other bank management functions, including copy, rename, create, and preset size, are pretty much self-explanatory. Refer to the Preset Management module, 4. Copy Preset, 2. Rename Preset, 5. Create Preset, and 6. Preset Size. Try these various functions to get a feel for how they work.

On Your Own...

The proceeding guided tours cover only the basics. To cover every possibility of how to use the ESI would drown you in words. It's better that you just start playing! The best way to learn about the ESI is to power up and dive right in. Remember, you can experiment as much as you want on stuff in the bank. You have to actually save the bank to disk in order to alter the contents of the disk. In case you're a nervous type, you can even lock the disk (see Disk Utilities in Chapter 4, Master/Global for more information).

Try to spend some time not playing, but rather practicing, with the instrument. After you're a bit more familiar with the ESI, read the manual and delve deeply into a particular module or function. The ESI is like an audio construction set, where sounds can be captured, held, processed, mutated, sped up, slowed down... and so much more. Take advantage of all it has to offer.

The more you practice with your ESI, the more you'll be able to put your personal stamp on the music you play. And when you do play, you'll know the instrument well enough so that you are free to concentrate solely on your music.

4

Master/Global

1. Master Tune	57
2. Rename Bank	57
3. Erase Bank	58
4. Effects	58
5. Export	59
6. Memory Available	60
7. Disk Utilities	60
0. SCSI Setup	61
1. Mount Drives	62
2. Rename Disk Bank	62
3. Erase Disk Bank	63
4. Lock Bank & Drive	63
5. Disk Status	64
6. Format Disk	65
7. Backup	67
8. Special	70
1. Recalibrate	71
2. Contrast	71
3. Headroom/Boost	72
4. Main Output Format	73
5. Software Version	74
6. View Channels	74
7. Trigger Buttons	74
8. RAM Test	75
9. MIDI	76
1. MIDI Mix	77
2. MIDI Globals	78
3. MIDI Load Bank	81
4. MIDI Volume Pedal	81
5. MIDI Volume/Pan	82
6. Multimode Enable	82
0. Import Options	83
0. Akai Import	83
1. Emax II Import	89

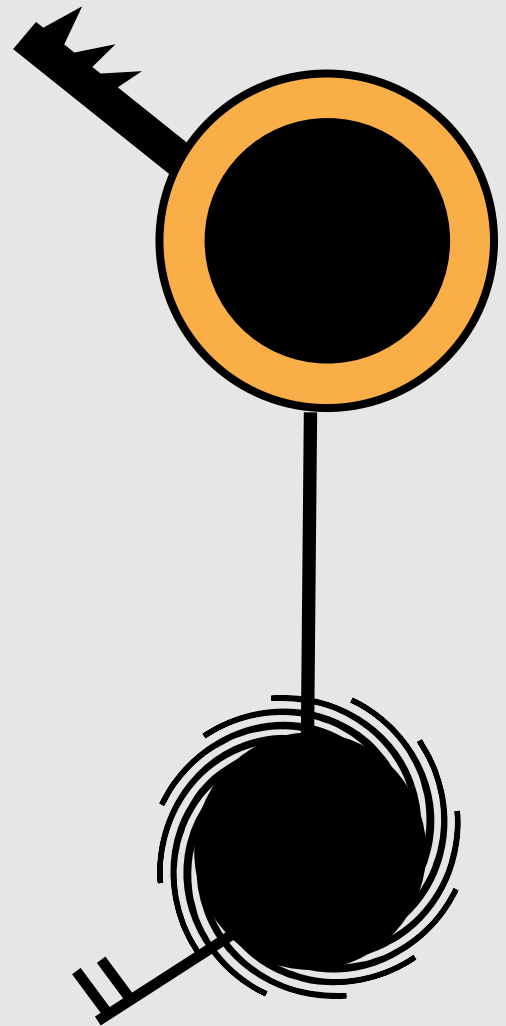

1. Master Tune

Master Tune adjusts the tuning of all the samples in the current bank, so that you can tune the ESI to other instruments.

1. **Activate Master/Global module.**
2. **Select Master Tune (1).**
3. **Select the desired tuning offset.** This is variable from -100 (one semitone below concert pitch) to +100 (one semitone above concert pitch).

MASTER TUNE
Offset: + 0.0 cents
Transpose: off
Select Tuning Offset

4. **Select the Transpose amount.** Transpose allows you to transpose the ESI without the use of a keyboard. The transpose range is \pm one octave.
5. **Press ENTER to exit the submodule.** The ESI will return to the Module Identifier.

2. Rename Bank

This submodule allows you to rename the current bank.

1. **Activate Master/Global module.**
2. **Select Rename Bank (2).**
3. **Rename the bank.** Choose the characters to be changed with the left and right cursor buttons. Select the desired characters by using the ten key pad, Data Entry Control and keyboard. You can also use the up cursor to insert spaces and the down cursor to delete spaces.

RENAME BANK
B01 Current Bank
[0-9]/Encoder/Kybd

4. **Press ENTER to exit the submodule.** The ESI will return to the Module Identifier

★ **Tip:** Use the Data Entry Control to access the complete character set. Most keyboards do not have enough keys to access all the available characters.

3. Erase Bank

Erasing a bank erases ALL the memory in the ESI, which includes all samples and presets.

1. **Activate Master/Global module.**
2. **Select Erase Bank (submodule 3).**
3. **Decide if you really want to erase the bank.** The display will inform you that you are about to erase all samples and presets in the current bank.

★ **Tip:** *After erasing the bank, the ESI will automatically create an empty bank for you.*

ERASE BANK
Erases All Presets,
and Samples!
Are You Sure? Y/N

4. **Press Yes to erase the bank or No to cancel the operation.** In either case, the ESI will return to the Module Identifier.

4. Effects

This function is available only when the Turbo Option Kit is installed in the ESI. For detailed instructions on how to use the Effects submodule, refer to the Appendix.

5. Export

Export Functions

This function allows you to save an ESI bank so that it can be read by a predecessor of the ESI. If the bank you are trying to save exceeds 8 MB, or has more than 100 presets or 100 samples, you will not be allowed to save as an EIII bank. The three export options are as follows.

- 0 **Save as v2.10 Bank:** Allows you to save 3.00 banks (this version) as 2.10 banks in order to remain compatible with older ESI's or EIV family samplers using EOS software below 3.00.
- 1 **Save as E3 Bank:** Allows you to save an ESI bank in the original EIII bank format so that it can be read by an EIII (The EIII is a predecessor of the ESI). If the bank exceeds 8 MB or has more than 100 presets or 100 samples, you will not be allowed to save as an EIII bank.
- 2 **Save as v1.04 Floppy:** Allows you to save 3.00 banks (this version) as 1.04 banks in order to remain compatible with older ESI's. Banks created in version 1.04 format must first be loaded into a v3.00 system, and then saved into v3.00 format before samples and presets can be loaded.

! Caution: *You cannot load individual presets and samples from floppy disks saved in version 1.04 software.*

► To Export a Bank:

1. **Make sure the bank you wish to export has been Saved to hard disk.**
2. **Press the Master key.** The LED illuminates and the Memory Statistics screen appears.
3. **Select the Export submodule (5).**
4. **Select one of the three options** using the Data Entry Control or by entering the number (0-2) from the numeric keypad.
5. A popup dialog box appears warning you that the resident bank will be destroyed as a result of the conversion process. (You DID save it first didn't you?) **Press Yes to continue.**

SAVE v2.10 BANK into
D0 Floppy Drive

Select a Drive

6. **Select the destination drive** for the v2.10 or EIII bank and **press Enter**. The bank will be saved. (Note: You cannot save an EIII bank to floppy disk.)
7. If you chose the Floppy Drive destination, insert the first disk and press Enter.

6. Memory Available

Memory Available shows how much of each type of memory is available, both as a percentage of available memory and in bytes. For example, if you have used up 90.0% of the available preset memory, the display will show that there is 10.0% preset memory remaining.

1. **Activate Master/Global module.**
2. **Select Memory Available (6).**
3. **Observe the display.** Line two displays the percentage and amount of preset memory available. Line three displays the percentage and amount of sample memory available. Line four inquires if you want to collect the memory.

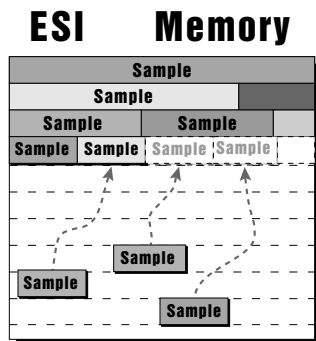

MEMORY AVAILABLE	
Preset:	99.8% 127K
Sample:	100% 32.0M
Collect Memory?	Y/N

- **Collect Memory** allows you to defragment the memory of the ESI. When samples are erased or truncated, the sample memory is left divided or fragmented until the bank is saved to disk. This may limit your sample size even though you have plenty of memory left.
4. **Press ENTER to exit the submodule.** The ESI will return to the Module Identifier.

7. Disk Utilities

Disk Utilities include several additional numbered subsections. Here are brief descriptions of each subsection. More extensive descriptions follow.

0. **SCSI Setup:** Allows you to change the ESI's SCSI ID number and configure SCSI for a Macintosh or PC on the bus.
1. **Mount Drives:** Instructs the ESI to check the SCSI bus for the presence of SCSI devices.
2. **Rename Disk Bank:** Allows you to change the name of any bank on any of the available hard drives.
3. **Erase Disk Bank:** Allows you to erase any bank from any of the available hard drives.
4. **Lock Bank and Drive:** Prevents a specific bank and/or drive from being overwritten.
5. **Disk Status:** For a hard disk drive, this function displays the amount of space that is available, and if the drive is locked or not. For floppy disks this function indicates the name and number of a bank disk, and if the disk is blank.
6. **Format Disk:** Initializes a floppy disk or a hard drive to store the ESI bank data.
7. **Backup:** Floppy disks and hard disk drives can and do fail from time to time. This function allows you to backup the hard disk contents on another hard disk or other SCSI media, and if necessary, reconstruct the hard disk from the data on the backup disk.

0. SCSI Setup

This utility allows you to change the SCSI ID number of the ESI itself (not a connected hard disk) in the event that it conflicts with a device on the SCSI bus having the same ID number.

The SCSI interface, located as a 50-pin connector on the back panel, allows the ESI to communicate with external storage devices. The ESI can support seven SCSI devices (including its internal HD if it has one). Each device on the SCSI bus has its own ID number so that it can distinguish its data from data meant for other SCSI devices. If a SCSI device is added to your system which has the same ID number as an existing device, a SCSI error would occur. To remedy this situation, the ID number on the new device will have to be changed. Consult the operation manual of the external device for information on changing the SCSI ID number.

The ESI also contains special SCSI software that allows two “master” devices (the ESI and a Macintosh, for example) to coexist on the SCSI bus. If you have a computer connected to the ESI SCSI bus, the “Ignore Host on ID” function should be set to the ID number of the computer so the ESI will not try to access the computer itself as one of its disk drives.

1. **Activate Master/Global module.**
2. **Select Disk Utilities (7), SCSI Setup (0).**
3. **Select the new SCSI ID number.**

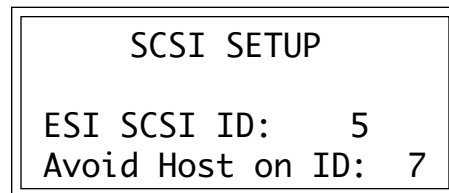

★ **Tip:** *The ID number of a Macintosh computer is set at 7.*

4. **If a computer is present on the SCSI bus set “Avoid Host on ID” to the computers SCSI ID number.** If a computer is not present on the SCSI bus, this function should be turned Off.
5. **Press ENTER to exit the submodule.** The ESI saves your choices to the System and returns to the Module Identifier.

1. Mount Drives

This utility instructs the ESI to check the SCSI bus for the presence of SCSI devices.

★ **Tip:** Use the "Mount Drives" utility whenever an external SCSI device does not appear in the list of available devices.

If a SCSI device has been powered up after the ESI, it will not appear in the list of available devices. The Mount Drives utility tells the ESI to check the SCSI bus and to add any SCSI devices that it finds to its list of available SCSI devices. Normally, if the external devices are powered up before the ESI, this will be done automatically.

1. Activate Master/Global module.
2. Select Disk Utilities (7), 1. Mount Drives (1).
3. The ESI will mount the drives, then return to the Module Identifier.

```
MOUNT DRIVES

Mounting Drives...
```

2. Rename Disk Bank

This function allows you to name your hard disk banks.

1. Activate Master/Global module.
2. Select Disk Utilities (7), Rename Disk Bank (2).
3. Select an installed drive, then press ENTER.

```
RENAME DISK BANK
D1  QUANTUM LP1055
B01 12 String
      Select a Drive
```

4. Select the bank to be renamed, then press ENTER.
5. **Rename the bank.** Choose the characters to be changed with the left and right cursor buttons. Select the desired characters by using the ten key pad, Data Entry Control and keyboard. You can also use the up cursor to insert spaces and the down cursor to delete spaces.

```
RENAME DISK BANK
D1  QUANTUM LP1055
B01 12 String
      [0-9]/Encoder/Kybd
```

6. Press ENTER to exit the submodule. The ESI will return to the Module Identifier.

3. Erase Disk Bank

With this utility, banks can be erased from any of the available drives.

! Caution: The display will advise you if you try to erase a bank or drive that is locked. Unlock the bank or drive before proceeding.

1. Activate Master/Global module.
2. Select Disk Utilities (7), Erase Bank (3).
3. If you wish to select a different drive, press the up cursor. If not, proceed to step 5.
4. Select the drive containing the bank to be erased, then press ENTER.

```
ERASE DISK BANK
D1  QUANTUM LP1055
B01 12 String
      Select a Drive
```

5. Select the bank to be erased, then press ENTER.

```
ERASE DISK BANK
D1  QUANTUM LP1055
B01 12 String
      Select a Bank
```

6. Decide if in fact you want to erase the selected bank. The display will ask if you're sure.
7. Press Yes to erase the bank or No to cancel the operation. In either case, the ESI will return to the Module Identifier.

4. Lock Bank and Drive

If you don't want to risk curious hands unintentionally erasing a bank or drive, here's a safeguard. A complete drive or any bank within that drive can be locked against inadvertent erasure or tampering, and subsequently unlocked as needed.

! Caution: When using multiple ESI's on the SCSI bus, the bank will only be locked when accessed from the ESI that locked it. Any other ESI on the bus can still erase the bank.

This function will not let you lock a floppy disk. To lock a floppy, open the write-protect window on the disk.

1. Activate Master/Global module.
2. Select Disk Utilities (7), Lock Bank/Drive (4).
3. If you want to lock a drive or change the current drive, press the up cursor button. If not, go on to step 6. The display will show the current drive and its lock status, whether on or off.

```
LOCK DRIVE:    off
D1 Current Drive

      Select a Drive
```

4. Select the drive to be locked or unlocked, then press ENTER.
5. Select whether lock is on or off, then press ENTER.
6. Select the bank to be locked or unlocked, then press ENTER.
The display will show the current bank and its lock status, whether on or off.

```

LOCK BANK:      off
D1 Selected Drive
B00 Current Bank
  Select a Bank
  
```

7. Select whether lock is on or off, then press ENTER. The ESI will return to the Module Identifier.

5. Disk Status

This function displays the amount of space that is available on a hard disk drive and if the drive is locked or not. For floppy disks, this function indicates if it is a software disk, the name and number of a bank disk, or if the disk is blank.

1. Activate Master/Global module.
2. Select Disk Utilities (7), Disk Status (5).
3. Select a drive, then press ENTER. If selecting the floppy drive, insert a disk before pressing ENTER.

```

DISK STATUS
D0 Floppy Drive

  Select a Drive
  
```

4. One of the following displays will appear:

```

DISK STATUS
D1 Main Drive
Avail: 20.7% 8.49Mb
 88 Banks  Unlocked
  
```

```

DISK STATUS
D0 Floppy Drive

Floppy Disk is Blank
  
```

5. If there is additional data about the drive, the Enter LED will be flashing. **Press ENTER to access the revision number and the type of drive.**

```
DISK STATUS
D1 Conner CFP21055
Rev 2847 Blksiz:512
Fixed Hard Disk
```

6. **To select another disk, press ENTER and return to step 3.**
7. **Press the Master/Global button to exit the submodule.**
The ESI will return to the Module Identifier.

6. Format Disk

Before a new floppy disk or hard disk can record or store any data, it first must be told how to record this data. This is called formatting. The floppy disk formatting procedure should be run on any new disk, or on recycled disks previously used with other systems (such as home computers), since these will not be formatted correctly for the ESI. Formatting a disk will not erase the bank currently in memory.

1. **Activate Master/Global module.**
2. **Select Disk Utilities (7), Format Disk (6).**
3. **Select the drive to be formatted and press ENTER.** The ESI defaults to the floppy drive.

```
FORMAT DISK
D0 Floppy Drive

Select a Drive
```

! Caution: *Although the ESI will accept standard single density diskettes, we recommend that you always use High Density diskettes. High density disks can be identified by the "HD" logo printed on the disk.*

4. **Consider the implications of your action.** Formatting a floppy or hard disk erases all information on that disk completely. The display will inquire if in fact you want to do this.
5. **Press Yes to continue the formatting procedure or No to cancel the operation and return to the Module Identifier.**
6. **If, in step 3, you selected the floppy drive, insert a high-density floppy disk, press ENTER.** Formatting takes about 60 seconds.
7. **After formatting a floppy disk, format another, if desired.** The display will ask if you want to format another floppy. To do this, press Yes, remove the current disk, insert a new disk, and press ENTER. Otherwise, press No to cancel the operation and return to the Module Identifier.

Formatting Hard Disks

This works exactly like formatting a floppy disk except when the display asks you to “Select a Drive”, you should select the hard disk instead of the floppy. If the hard disk is not listed, use Disk Utilities 1, to Mount Drive. The hard disk drive should now be listed. Formatting a hard drive takes several minutes, depending on the size of the HD.

Formatting Read/Write Optical Disks

Read/Write Optical disks are formatted in the same way as a hard disk. Use optical disk cartridges with 1024 bytes/sector. New optical disk cartridges usually come with the “low level” formatting already in place. If so, the disk will format normally. If this low level formatting has not been performed, the ESI will interrupt the formatting process and show a “SCSI Hardware Error”. If this happens, follow the procedure for Low Level formatting on the next page, then format the disk in the normal way.

Note: Optical disks always verify the data as it is written and so do not require the long verify process that occurs after formatting has been completed. You can save hours of time by ejecting the cartridge and re-booting the system after the “VERIFYING FORMAT” message appears in the ESI display (about 10 seconds).

Hard Disk Interleave

The ESI contains an internal list of recognized hard disk drives which also contains parameter information designed to optimize the interface between the ESI and the drive. Most new hard disk drives use 1:1 interleave. The Appendix contains a listing of disk drives that have been tested with the ESI. Other types will probably also work. If in doubt, the best idea is to try out the drive with the ESI before you buy it.

HD Interleave Options

There is a hidden menu when the display asks: “Are You Sure?”

Before choosing Yes or No you may choose one of the following hard disk interleave options using the numeric keypad:

	0 --- Uses the ESI's default interleave for the type of HD.
Fast	1 --- 1:1 interleave
	2 --- 2:1 interleave (this is the ESI's default setting)
	3 --- 3:1 interleave
	4 --- 4:1 interleave
	5 --- 5:1 interleave
	6 --- 6:1 interleave
Slow	7 --- 7:1 interleave
	8 --- Install File System
	9 --- Optical Disk Low Level Formatting

★ **Tip:** The recommended type of Magneto-Optical drive for the ESI uses the Sony type cartridge. Brand names include Sony, Pinnacle, PLI and Alphatronics to name a few.

! **Caution:** Be sure to use Option #8 when formatting **lomega Zip** drives. The normal formatting procedure cannot be used with Zip drives.

! **Caution:** Most hard disks now are 1:1 interleave. 1:1 is the ESI default so you probably will not need to change this.

Option #8 allows you to install the ESI file system on a pre-formatted hard disk. This option is quite handy since it saves the time of formatting. Many hard disk drive brands of now come pre-formatted.

Option #9 allows you to perform a low level format on a “virgin” optical platter (of the Sony type only). Most optical disks that you buy will already have this low level formatting, but some don't and will not be recognized by the ESI. This utility allows you to perform the function. This takes about 25 minutes, so don't do it unless absolutely necessary.

7. Backup

This module allows you to backup and restore a portion or the entire contents of the hard disk. This function makes it so easy that you really will have no excuse for not backing up all your hard disk banks. If you'd hate to lose it, BACK IT UP.

To Backup to another Hard Disk:

1. When the display asks you for the source drive (from), select the disk drive to be backed-up, then press ENTER.

! Caution: In order to use the backup function, BOTH drives must be unlocked.

```
BACKUP from
D0 Main Drive

Select a Drive
```

2. The display asks you for the destination drive (into). Select the disk drive to which the information will be saved, then press ENTER.

! Caution: A disk drive cannot be backed-up to itself.

```
BACKUP into
D0 Main Drive
D1 Removable Media

Select a Drive
```

3. Select between Automatic or Interactive backup modes.

```
BACKUP from
D0 Main Drive
D1 Removable Media
Mode: Interactive
```

- **Automatic Mode:** transfers the complete contents of the source hard disk (or just the updated banks) to the destination drive without prompting you at each bank.
- **Interactive Mode:** transfers the banks of the source hard disk drive to the destination drive, but prompts you to select each source and destination bank.

4. **Select the backup mode and press ENTER.**

5. **Select the Bank Type.** The display shows:

```

BACKUP from
D0 Main Drive
D1 Removable Media
Bank Type: All
  
```

- **All:** Copies all the banks on your hard disk.
- **Range:** Copies a selected range of disk banks.

6. **Select the bank type and press ENTER.** If you selected All or Updated as the bank type, the screen shown in step 9 will appear.

If you selected Range as the bank type the following screen will appear:

```

BACKUP Low Range:
D0 Main Drive
D1 Removable Media
13 Baby Burps
  
```

7. **Select the low bank of the range.** In this menu, you select the lowest bank in the range of banks which will be copied to the destination hard disk.

```

BACKUP High Range:
D0 Main Drive
D1 Removable Media
22 Dog Barks
  
```

8. **Select the high bank of the range.**

9. **Press ENTER when the highest bank in the range has been selected.** The following screen will appear:

```
BACKUP
D0 Main Drive
D1 Removable Media
Bank Dest: SameBank
```

- **Same Bank:** Copies the banks into the same numbered bank locations on the destination disk.
- **Empty Bank:** Copies the banks into the lowest consecutive empty bank locations on the destination disk.

10. Select the bank destination and press ENTER. The display will inquire if you are sure. Press Yes if you are, and backup will proceed. Press No to cancel the operation and return to the Module Identifier.

During the Backup procedure, the display will show the banks being copied.

To Restore:

To restore your backed-up disk, simply reverse the source and destination drives following the directions for backup.

8. Special

This section contains several additional numbered functions. Here are short descriptions of each submodule. More extensive descriptions follow.

1. **Recalibrate:** Allows you to recalibrate the action of the data and volume sliders on the front panel.
2. **Contrast:** This function allows you to adjust the contrast of the front panel LCD .
3. **Headroom/Boost:** Allows you to adjust the amount of available headroom of the ESI's D/A converters.
4. **Main Output Format:** This function adjusts the ESI for optimum performance when using either the main analog outputs or the optional digital I/O.
5. **Software Version:** States the current version of the operating system software.
6. **View Channels:** Allows you to monitor your channel usage with a bar graph of each channel's level.
7. **Trigger Buttons:** Programs the ten-key pad to trigger keyboard notes without a MIDI keyboard when the ESI is in Trigger Mode.
8. **RAM Test:** Tests the CPU and the sample memory and displays any errors. You should perform this test if you increase the amount of sample RAM in the ESI.

To Access Any of the Special Functions:

1. Activate Master/Global.
2. Select the Special (8) submodule and press ENTER.
3. Select the desired function in the submodule and press ENTER.

1. Recalibrate

With this function you can set minimum and maximum values for the volume control. If you feel that the volume control is not working correctly, it may be time to recalibrate.

1. Activate Master/Global module.
2. Select Special (8), Volume Recalibrate (1).
3. Move the volume control to the minimum position, then press ENTER.

VOLUME RECALIBRATE
Min: - 12245

Set Minimum Volume

4. Move the volume control to the maximum position, then press ENTER again.

VOLUME RECALIBRATE
Min: - 12245
Max: + 13352
Set Maximum Value

5. Check the movement of the control. Verify that the volume control operates properly. Press ENTER.
6. To save the calibration, press Yes. To cancel the calibration, press No. In either case, the ESI will return to the Module Identifier.

2. Contrast

This function allows you to change the viewing angle of the LCD so that it may be easily read from either above or below. The angle is adjustable from +7 to -8. Positive values make the display easier to read from above. Negative values make the display easier to read from below.

1. Activate Master/Global module.
2. Select Special (8), Contrast (2).
3. Select the desired contrast setting.

CONTRAST

Contrast: -2
Select Contrast

4. Press ENTER to exit the submodule. The ESI will return to the Module Identifier.

3. Headroom/Boost

Headroom is the amount of dynamic range remaining before clipping will occur. Sampling instruments are quite different from a CD player, since a sampler plays multiple channels at once. Each channel boosts the headroom requirement by 3 dB. The amount of headroom on the ESI is adjustable from 0 dB to 15 dB in 1 dB increments (with the front panel volume control set to maximum). A headroom setting of 0 dB for example, will provide the hottest output level, (and the highest signal to noise ratio) but may cause “clipping” if too many notes are played at once. The default headroom setting is 3 dB, which maintains an excellent signal to noise ratio while keeping a reasonable amount of headroom in reserve. If you hear clipping from the ESI, raise the amount of headroom. The headroom setting is retained when power is switched off.

★ **Tip:** The headroom adjustment also controls the level on the optional S/PDIF digital audio output.

1. Activate Master/Global module.
2. Select Special (8), Headroom (3).
3. Select the desired amount of headroom. The amount of remaining headroom is variable from 0 dB to 15 dB in 1 dB increments.

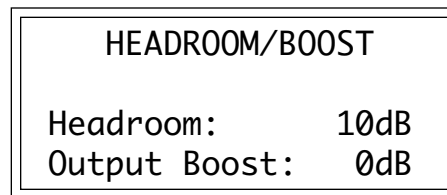

4. Press ENTER to exit the submodule. The ESI will return to the Module Identifier.

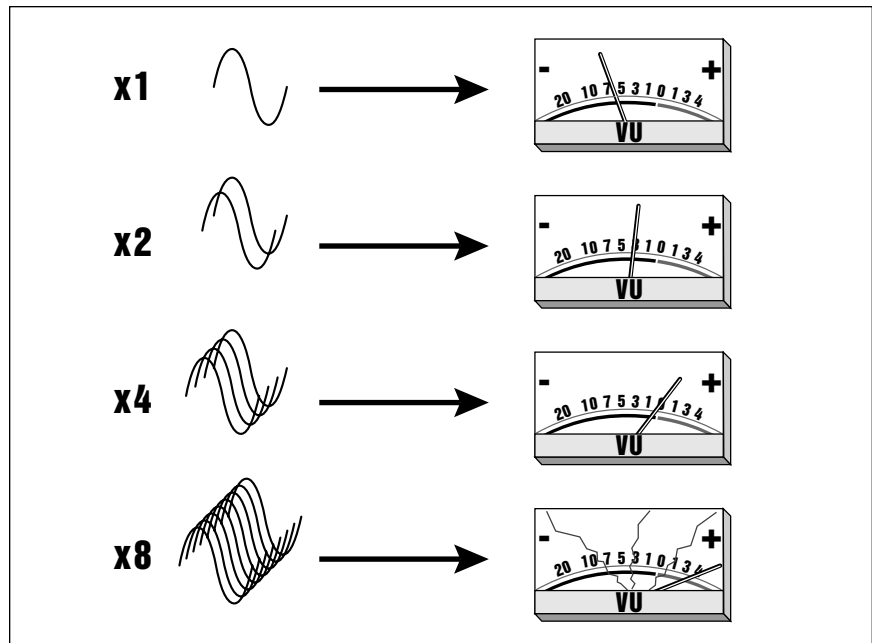

Each channel played adds +3 dB to the output level. Increase the headroom to prevent clipping.

! Caution: Be sure to set Main Output Format correctly for the type of output you are using or degraded audio performance could result.

Output Boost digitally raises the output level by +12 dB and is related to the headroom control. The +12 dB boost provides the best signal-to-noise ratio when only one or two channels are being played at a time. However, playing back too many channels with the output boosted may cause the output signal to clip. The Headroom control can be used to reduce the effect of Output Boost. (0 dB of headroom = maximum boost.) Output Boost affects both the analog and digital outputs.

1. Press the Master/Global key.
2. Select Special (8), Headroom/Boost (3).

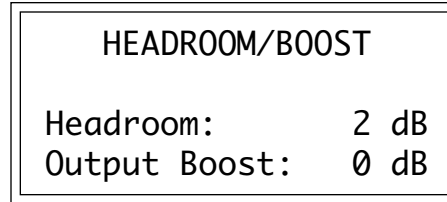

3. Set the Output Boost to +12 dB.
4. Press ENTER to exit the submodule. The ESI will return to the Module Identifier.

4. Main Output Format

The optional Turbo card adds a digital audio output for interfacing with other digital audio gear. The digital audio interface carries two channels of audio information which duplicates the audio at the main outputs. Both the analog and digital outputs are always active. Set the format to optimize the ESI's output for whatever format is being used. The Output format can be optimized for AES pro, AES consumer (S/PDIF) or analog output.

1. Activate Master/Global module.
2. Select Special (8), Output Format (4).

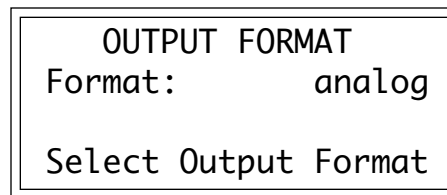

3. Set the Output to the format you are using.
4. Press ENTER to exit the submodule. The ESI will return to the Module Identifier.

5. Software Version

1. Activate Master/Global module.
2. Select Special (8), Software Version (5).

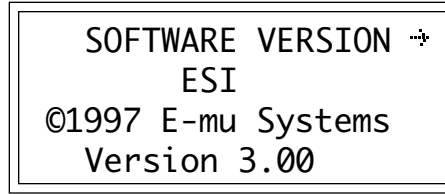

3. The display shows the disk software version.
4. Press the right cursor key to view the credits. The names of the ESI design team are listed, thank-you very much.
5. Press ENTER to exit the submodule. The ESI will return to the Module Identifier.

6. View Channel Levels

This is a channel monitor screen which enables you to see the volume envelope status of all 64 voice channels. This is a useful feature when you are playing back complex sequences and want to know how many channels you have left.

1. Activate Master/Global module.
2. Select Special (8), View Channels (6).
3. Use the left/right cursor buttons to place the cursor under the channel to be disabled.

★ **Tip:** See also, *Trigger Mode*, in the *Controls* chapter of this manual.

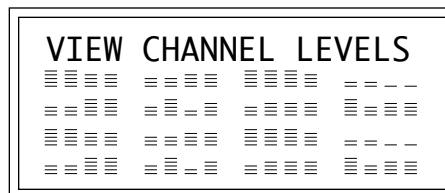

4. Press Escape to exit the submodule. The ESI will return to the Module Identifier.

7. Trigger Buttons

This function lets you assign the ten-key pad buttons to trigger specific notes directly from the ten key pad, whenever trigger mode is selected from the front panel button. When the mode is set to latch, pressing a key toggles that note on. Pressing the same key again will toggle the note off. This mode is useful when you want to trigger a looped sample (such as background ambience) and have it continue playing without having to hold the key. The trigger buttons operate on the current preset and their settings are saved with the bank.

! **Caution:** Pressing 3 or more buttons MAY cause one or more "unpressed" buttons to play.

1. **Activate Master/Global module.**
2. **Select Special (8), Trigger Buttons (7).**
3. **Use the left/right cursor keys to select the button.** Use the Data Entry Control, the INC/DEC buttons or your MIDI keyboard to select the key to be played. Play the ten key pad to hear the trigger buttons.

TRIGGER BUTTON 1 ↔	
Key:	C1
Velocity:	112
Mode:	off

4. **Set the velocity for the trigger button (1-127).** This is the velocity that will be used whenever the trigger button is pressed.
5. **Select the mode for each trigger button.** Mode “On” plays a key whenever the button is pressed. “Latch” mode holds the key on until the button is pressed again.
6. **Press ENTER to exit the submodule.** The ESI will return you to the Module Identifier.

8. RAM Test

RAM is an acronym for Random Access Memory. RAM is used to store presets and samples in the ESI's bank. There is also another block of RAM used by the ESI's main computer. This function allows you to test the memory by first filling it with numbers and then reading them back.

A RAM test should always be performed after you have updated the amount of sample memory in your ESI. The test will verify if the new RAM is working and has been correctly installed.

! Caution: *Dangerous voltages are present inside the ESI enclosure. Consult your local E-mu dealer or call E-mu customer service for information about updating RAM.*

- Use only low profile SIMMs in the ESI.

1. **Activate Master/Global module.**
2. **Select Special (8), Ram Test (8).** The following screen will appear.

<p>RAM TEST WARNING Clears Sample Memory Proceed? Y/N</p>

3. **Press Yes to begin the test. Press No, Exit, or Enter to return to the Submodule Identifier.**

4. If you pressed **Yes**, the CPU RAM test will begin and the amount of RAM in the machine will be displayed. Allow the CPU RAM test to run through several cycles (C: = cycles). **Press ENTER to proceed to the sample RAM test.**
5. The Sound RAM Fixed Test will begin. After four cycles, the Random test will begin. Allow the test to run completely through several cycles. **Press ENTER to stop the test.** Any memory errors will be displayed.
6. **Press ENTER again to exit the submodule.** The ESI will return you to the Submodule Identifier.

9. MIDI

This section contains several additional numbered functions. These MIDI global functions act on all presets in the ESI. Here are short descriptions of each submodule. More extensive descriptions follow.

1. **MIDI Mix:** Allows you to monitor and change the volume and pan settings of all 16 MIDI channels at once. It also lets you override the submix output settings made in the zone and assign them according to MIDI channel.
2. **MIDI Globals:** MIDI global commands override the MIDI settings programmed for each preset in the Preset Definition module and return us to a simpler time when MIDI settings affected all presets.
3. **MIDI Load Bank:** This feature allows a MIDI command to load banks from a hard disk.
4. **MIDI Volume Pedal:** Allows an external MIDI controller (pedal) to function like a master volume pedal.
5. **MIDI Volume/Pan:** This function automatically routes the MIDI controllers 7 and 10 to volume and pan. It also disables controllers 7 and 10 in the Preset Definition MIDI submodule.
6. **Multimode Enable:** Selects whether or not Multimode On/Off is set globally or dependent on each bank.

To Access Any of the MIDI Functions:

1. Activate Master/Global.
2. Select the MIDI Submodule (9) and press ENTER.
3. Select the desired Submodule and press ENTER.

1. MIDI Mix

The MIDI Mix screen is extremely useful in that it allows you to easily fine tune the volume and pan of each preset. In addition, it allows you to override the output channel setting programmed in the Dynamic Processing module and route each MIDI channel to the output of your choice. These volume and pan settings can also be accessed from the multimode screen, but the MIDI Mix may be more convenient for mixdown, since the volume and pan settings for all channels are visible. Any volume and pan changes made over MIDI will be reflected in the screen. (Volume = MIDI continuous controller channel #7, Pan = MIDI continuous controller channel #10)

1. **Activate Master/Global module.**

2. **Select MIDI (9), MIDI Mix (9).**

3. **Select a MIDI channel.** Use the left-right cursor buttons to scroll through the MIDI channels. Each time you press the cursor button, the cursor moves to the next channel's bar graph volume display in line two. The top line of the display shows the MIDI channel and a decimal readout of the volume setting for that channel. Use the Data Entry Control or INC/DEC buttons to change the volume levels.

★ **Tip:** You must be in Multimode in order to change channels in the MIDI Mix screens.

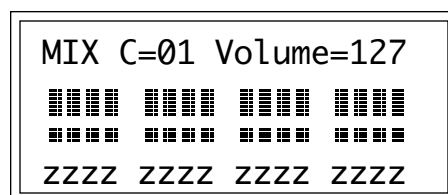

4. **Move the cursor down to line three.** The volume display on line one now changes to display the pan setting for the currently selected MIDI channel. Pan *adds* to the pan setting made in the dynamic processing zone it is NOT an absolute pan setting. Use the left-right cursor buttons to scroll through the MIDI channels.

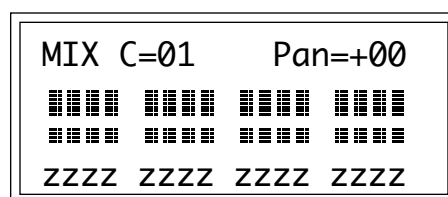

5. **Move the cursor to line four of the display.** The pan display on line one now changes to display the output channel assignment for the currently selected MIDI channel. Use the Data Entry Control or INC/DEC buttons to select the main outputs, submix outputs, or zone (z), in which the output will be determined by the zone assignments in the preset assigned to that MIDI channel. Selecting main, or sub will override the output channel selections made in the Dynamic Processing module. Use the left-right cursor buttons to scroll through the MIDI channels.

```

MIX C=01 Submix=main
||||| ||||| ||||| |||||
||||| ||||| ||||| |||||
Mzzz 111z zzzz zzzz

```

6. Press ENTER to exit the submodule. The ESI returns to the Module Identifier.

2. MIDI Globals

MIDI (Musical Instrument Digital Interface) is a universal interface which allows the exchange of musical information between various electronic instruments. The global MIDI parameters affect the entire ESI.

1. Activate Master/Global module.
2. Select MIDI (9), MIDI Globals (2). This submodule contains four pages, as selected with the cursor/page buttons.
3. Move the cursor to the parameter(s) to be adjusted, and select the desired value(s) with the Data Entry Control. The first page shows:

Omni Mode - The ESI receives MIDI data on any and all channels, but plays only the current preset.

Poly Mode - The ESI receives MIDI data only on the selected MIDI channel, and plays the current preset.

Multi Mode - (Multi LED lit) The ESI receives MIDI data on any and all channels, and plays the preset assigned to each MIDI channel in the Multi screen.

```

MIDI GLOBALS
Basic Channel: 1
MIDI Mode:     omni
Rcv Prog Change: on

```

- **Basic MIDI Channel:** This is the default channel over which the ESI will send and receive MIDI information.
 - **MIDI Mode:** In Omni mode, the ESI will receive data transmitted over any of the 16 MIDI channels. In Poly mode, the preset will receive data only over the specified channel.
 - **Receive Program Change:** When this function is turned Off, the ESI will ignore incoming MIDI program change commands. When On, the ESI responds to MIDI program changes normally.
4. Select page two by pressing the right cursor button. Pages 2 through four select which MIDI continuous controllers will be received by the ESI. The second page shows:

```

MIDI GLOBALS
Pitch Control -> pwh
Mod Control -> 1
Pressure Control->chp

```

A few of the standardized MIDI controller numbers are listed below.

- 1 - Modulation Wheel or Lever
- 2 - Breath Controller
- 4 - Foot Pedal
- 5 - Portamento Time
- 6 - Data Entry
- 7 - Volume
- 8 - Balance
- 9 - Undefined
- 10 - Pan

pwh - Pitch Wheel

chp - Channel Pressure

- **Pitch Control:** Assign the global pitch control to a MIDI continuous controller number. A continuous controller receives realtime controller information from sources that are adjustable while you play such as the pitch wheel, modulations wheel, control pedal, footswitches and control sliders. Available assignments include off, controllers 00 through 31, pwh (pitch wheel), or chp (channel pressure). Normally assigned to pwh. The normal assignment for Pitch Control would be pwh.
 - **Mod Control:** Assign the Modulation Control to a MIDI continuous controller number. The process is exactly the same as assigning a controller to Pitch Control. Normally assigned to #1.
 - **Pressure Control:** (Aftertouch) Assign keyboard mono pressure to a MIDI continuous controller number. Normally assigned to chp.
5. **Select page three by pressing the right cursor button.** The third page shows:

MIDI GLOBALS		
Pedal Control	->	3
MIDI A Control	->	4
MIDI B Control	->	5

★ **Tip:** Although the controllers have been given names such as "Pitch Control, Pedal Control" etc., any MIDI controller number can be assigned to them. For example, the modulation wheel could be assigned to the Pedal Control by setting it to continuous controller 1.

- **Pedal Control:** Assign the foot pedal to a MIDI continuous controller number. The process is the same as assigning a controller to the left wheel. Normally assigned to #4.
- **MIDI A Control:** Assign MIDI Control Source A to a MIDI continuous controller number. MIDI A is simply another control source and can be assigned to any MIDI continuous controller number desired. Follow the same procedure used for the other controllers.
- **MIDI B Control:** Assign MIDI Control Source B to a MIDI continuous controller number. This works the same way as assigning MIDI Control Source A to a MIDI continuous controller number.

★ **Tip:** Pedals and footswitches are received by ESI over MIDI. Your MIDI keyboard will probably have inputs for a pedal and footswitch. In order to receive this data, your keyboard and ESI must be set to the same continuous controller number.

EXAMPLE: Here is an example of how MIDI control sources work. Refer to the diagram on the following page. Suppose a sequencer is sending out modulation data over MIDI control number 01, and that MIDI Control Source A on the ESI controls the filter cutoff frequency. Selecting 01 for MIDI Control Source A would route the sequencer's modulation data to the ESI's filter cutoff frequency, assuming that the sequencer's MIDI Out feeds the ESI's MIDI In.

You can think of the control assignments as Patchcords. You must connect both ends for the connection to be made.

One end of the "patchcord" is connected in this submodule, and the other end is connected in the Preset Definition, Realtime Controls submodule.

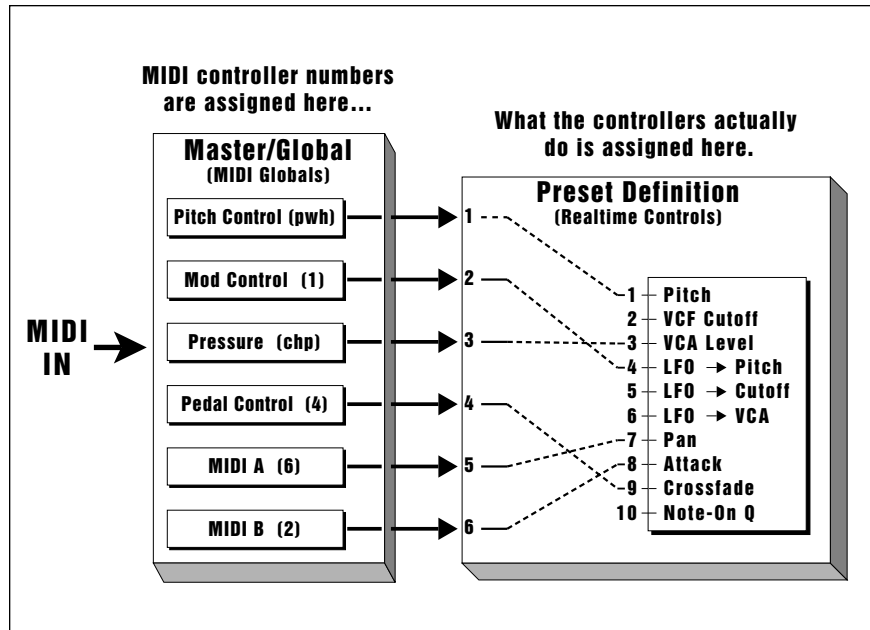

In order to use the MIDI controllers, you must assign both a source (MIDI screen) and a destination (Realtime Controls screen).

6. Select page three by pressing the right cursor button. Page four shows:

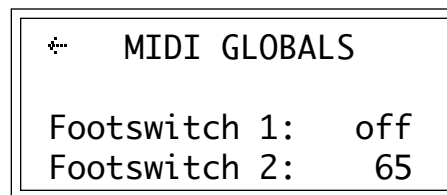

The footswitch assignments are like the other control assignments except that they control switch functions (also assigned in the Preset Definition, Realtime Control submodule) such as Sustain, Sample Cross-switch, etc.. This screen allows you to match the ESI to your MIDI controller's footswitch numbers.

A few of the standardized MIDI switch numbers are listed below.

- 64 - Sustain Switch
- 65 - Portamento Switch
- 66 - Sostenuato
- 67 - Soft Pedal
- 68 - Hold Pedal 2

- **Footswitch 1:** Assign footswitch 1 to a MIDI switch controller number. Available assignments include Off and switch controllers 64 through 79.
- **Footswitch 2:** Assign footswitch 2 to a MIDI switch controller number. The process is exactly the same as assigning a switch controller to footswitch 1.

8. Press **ENTER** to exit the submodule. The changes will be stored and the ESI will return to the Module Identifier.

3. MIDI Load Bank

This feature allows a MIDI command to load banks from the hard disk. The “Magic Preset” is a preset number which tells the ESI that the next preset change command that it receives over MIDI is the bank number to be loaded. Therefore, to load a hard disk bank over MIDI, two program change commands must be sent, the Magic Preset and the bank number. For example, if the Magic Preset is set at “085”, and the ESI receives a preset change command of 085 followed by a preset change command of 011, the ESI will load bank 011 from the hard disk. If multiple SCSI drives are connected, the ESI will load from the drive most recently accessed. The Magic Preset is user definable and can be turned off or set to any preset number from 000 to 127. MIDI Load Bank always works, regardless of MIDI Global settings.

1. Activate Master/Global module.
2. Select MIDI (9), MIDI Load Bank (3).

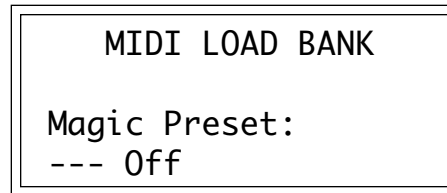

3. Select the Magic Preset or Off to disable MIDI Load Bank.
4. Press ENTER to exit the submodule. The changes will be stored and the ESI will return to the Module Identifier.

4. MIDI Volume Pedal

This command overrides any footpedal assignments made in the Preset Definition, Realtime Controllers submodule and forces the footpedal to become a volume pedal (emulating the front panel volume knob). Volume Pedal Global Override can be turned On or Off (default is Off). This setting is stored as part of the System Software and will remain in its setting after the ESI is powered down and re-booted.

1. Activate Master/Global module.
2. Select MIDI (9), Volume Pedal (4)

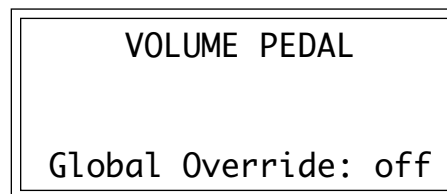

3. Select whether volume pedal global override is on or off.
4. Press ENTER to exit the submodule. The changes will be stored and the ESI will return to the Module Identifier.

5. MIDI Volume/Pan

When this function is turned On, the MIDI continuous controllers 7 and 10 will automatically be routed to volume and pan whenever the ESI is in multimode (Volume and Pan are the standard functions of controller number 7 & 10.) and their assignments in the Preset Definition submodule will be ignored. When not in multimode, MIDI controllers 7 and 10 function as programmed in the Preset Definition submodule.

When MIDI Volume/Pan is turned Off, volume and pan must be programmed for each preset in the Preset Definition MIDI submodule.

1. Activate Master/Global module.
2. Select MIDI (9), Volume/Pan (5).

```
MIDI VOLUME/PAN
Route MIDI volume &
pan to MIDI Mix in
multimode?      yes
```

3. Select whether or not you want the ESI to automatically respond to the volume and pan MIDI controllers (7 & 10) when in multimode.
4. Press ENTER to exit the submodule. The changes will be stored and the ESI will return to the Module Identifier.

6. Multimode Enable

Multimode Enable consists of two functions. “Boot in Multi” automatically turns multimode on whenever the unit is powered up. When “Use Bank State” is enabled (yes), the state of Multimode (on or off) will be saved along with the bank. Therefore, if multimode was on when the bank was saved, it will be turned on when the bank is loaded.

1. Activate Master/Global module.
2. Select MIDI (9), Multimode Enable (6).

```
MULTIMODE ENABLE

Boot in Multi:  yes
Use Bank State: yes
```

3. Select whether or not you want Multimode to be global or bank dependent, then press ENTER.
4. Press ENTER to exit the submodule. The changes will be stored and the ESI will return to the Module Identifier.

0. Import Options

This section contains the import utilities which are used to load and convert sound files from other equipment.

- **0. Akai Import:** Allows the ESI to read and convert programs and samples from the Akai S1000 and S1100 samplers.
- **1. Emax II Import:** Allows the ESI to read and convert presets and samples from the Emax II sampler.

To Access Any of the Import Functions:

1. Activate Master/Global
2. Select the Import submodule (0) and press ENTER.
3. Select the desired import function and press ENTER.

0. Akai Import

The Akai Import function allows you to import Programs, Samples or entire Volumes from the Akai S1000 (and S1100) samplers and convert them into an ESI bank. Data is imported into the ESI, from an Akai formatted SCSI device. Load time varies and may be either slightly longer or shorter than the Akai. There are a few fundamental differences between the Akai samplers and the ESI. For this reason a number of the Akai program parameters are ignored during the conversion process. In most cases, however, the converted programs and samples should sound and behave very similarly to the originals.

1. Activate Master/Global module.
2. Select, Import (0), Akai Import (0).

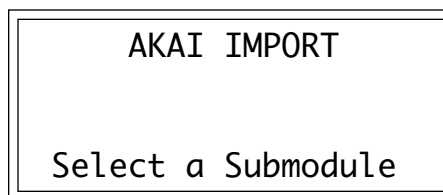

3. Select the desired import function. There are three options available. Refer to the chart below.

0. Akai SCSI Setup

Allows the ESI to specify the ID of the Akai device.

1. Akai Import Options

Contains several options related to the import process.

2. Akai Load/Convert

Allows you to browse through the Akai SCSI device, select the volume, programs or samples to import and start the import process.

An Akai SCSI device is NOT mounted and accessed like a normal ESI drive (the load and drive buttons will not access the Akai drive). Instead, it is accessed and operated using the Akai menus. Only one Akai SCSI device can be known to the ESI at any given time.

4. **Press 0 on the keypad to select Akai SCSI Setup.** This step is necessary for the ESI to recognize the Akai SCSI device. The display shows:

```
AKAI SCSI SETUP ⌂
SCSI drive ID:search
TOSHIBA CD-ROM DRIVE
Select search or ID
```

! Caution: Drive 0 cannot be used since the ESI uses this number for the floppy disk.

The setup screen is used to select the SCSI ID of the attached Akai SCSI device. The SCSI ID may be selected by using the INC/DEC buttons, or by typing the digit (1-7) directly using the ESI keypad. The default choice, “Search,” instructs the ESI to search for the first Akai device in the SCSI chain. Normally you will use “Search” unless you want to select a specific Akai device out of several on the SCSI bus. Press ENTER, to confirm your choice and return to the option select screen.

- **WARNING:** If you have an Akai S1000 or S1100 connected to the SCSI bus, you MUST enter the SCSI ID number of the Sampler (not the HD) manually. Failure to do so will cause the system to crash. Press the right cursor button for the next screen, then select the ID number of the S1000 or S1100. This ID number is remembered on power down.

5. **Press 1 to select the Import Options screen.** The following screen will appear. Press ENTER when you have selected your choices.

```
AKAI IMPORT OPTIONS ⌂
Adjust loops:      on
Full placement:   on
Combine -L/-R:    off
```

Adjust Loops

Sample looping is implemented differently on the ESI and the Akai. Because of this difference, certain sample loops may “tick” slightly or appear out of tune after being transferred from the Akai. This function will automatically repair any incorrect sample loops immediately after the samples are transferred. Be advised that the transfer may take slightly longer (up to 15% more time) with Adjust Loops turned On.

Full Placement

The Akai files may have samples placed on multiple layers in a program. The ESI only allows a primary and secondary layer in a preset. Turning the Full Placement function On instructs the ESI to create “Linked” ESI presets if an Akai preset has more than 2 layers. Velocity crossfade assignments for these links will be ignored. Any linked presets will be placed after the main presets in the preset list.

If Full Placement is set to Off, the first two samples assigned to a key will be placed in the primary and secondary positions for the key, and any subsequent samples assigned to the key will be ignored.

Combine -L/-R

When this option is set to “On”, the ESI will look within an Akai keygroup for left/right samples that can be combined into a single stereo sample. If the first 10 characters of the 12 character sample name match, and the last two characters of the two samples are ‘-L’ and ‘-R’, they are combined into an ESI stereo sample. Program parameters for the new stereo sample are taken from the left sample. The right side parameters are ignored.

When Combine -L/-R is set to “Off”, stereo samples are not combined and each sample will be placed in a separate ESI zone.

6. Select page two by pressing the right cursor.

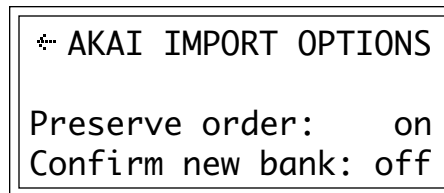

Preserve Order

When set to “On”, the ESI will attempt to map Akai program numbers to the ESI preset numbers. If extra “link” presets need to be created in order to place all samples within an Akai program, they will be placed after all the base presets.

For example, the Akai S1000 permits multiple programs to have the same program number (as a way of linking multiple sounds). If three programs are set to program number, and “Preserve Order” is On, the ESI will place the first program at preset 0 (if it not already filled), and the next two at locations 126 and 127. All three presets will be linked together so that all will sound when preset 0 is selected.

When Preserve Order is turned “Off”, presets will be placed sequentially in the lowest free preset location.

Confirm New Bank

When this function is set to On, the ESI will issue an extra prompt whenever a load operation is about to destroy the current bank.

Akai Mini-Glossary

Partition = Akai hard disks are divided into partitions of 30, 40, 50, or 60 megabytes, unlike the ESI which sees the hard disk as one continuous area.

Volume = An Akai partition can contain up to 128 Volumes. A volume is a collection of programs, equivalent to an ESI bank. Volumes are limited to a total of 64 sample, “program” and “drum setting” files.

Program = Equivalent to an ESI Preset.

Akai Load

7. **Press 2 to select the Akai Load/Convert screen.** Immediately after Load/Convert is selected, the ESI will attempt to read and verify the Akai disk using Search mode or using the SCSI ID selected in the SCSI Setup screen. If Search mode was selected, the following screen will appear:



AKAI LOAD

Searching...

★ **Tip:** The cursor buttons can be used to go back to the previous field.

If an Akai disk cannot be found, an error message will be generated indicating: “No Akai Drive Found”. If a valid Akai device is found, the following screen will appear:

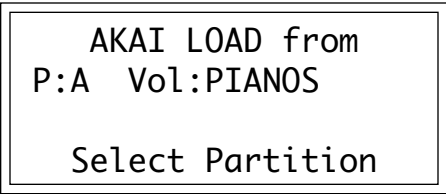

AKAI LOAD from
P:A Vol:PIANOS

Select Partition

8. Use the INC & DEC buttons to select the Partition number, then use the right cursor button to move to the next parameter (or press ENTER).

“P” stands for Partition. Akai partitions are indicated by letters A-Z. The first volume in the partition is displayed next to the partition letter.

9. Use the INC & DEC buttons or the Data Entry Control to select the Volume. When the desired Volume is located, press ENTER or use the right cursor button to move on to the next screen.

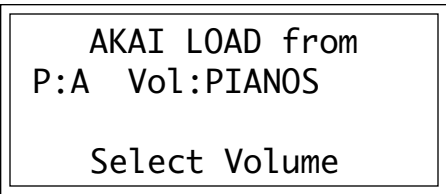

AKAI LOAD from
P:A Vol:PIANOS

Select Volume

10. Use the INC/DEC buttons or the Data Entry Control to select the Program. Press ENTER to load and convert a single program. “All” allows you to load and convert all programs in the volume. Selecting “None” allows you to load samples only.

```
AKAI LOAD from
P:A Vol:PIANOS
Program:FullGrand
Select Program
```

If “All” is selected, the following screen will appear:

```
AKAI LOAD from
P:A Vol:PIANOS
Program:**all**
Overwrite Bank? Y/N
```

! Caution: *If a converted preset NAME already exists in the current bank, two presets may be created with the same name, even though they might be different.*

Programs and samples may be loaded into a new bank (Overwrite Bank = Yes) or merged with the existing bank (No).

11. Press Yes to overwrite the current bank or No to merge the programs with the existing bank. Loading will begin immediately.

```
AKAI LOAD from
P:A Vol:PIANOS
Program:**none**
Select Program
```

If “None” is selected, the following screen will appear:

```
AKAI LOAD from
P:A Vol:PIANOS
Sample: **all**
Select Sample
```

12. Use the INC/DEC buttons or the Data Entry Control to select the Sample. Press ENTER to load and convert a single sample.

- “All” allows you to load and convert ALL samples in the volume.

If “ALL” is selected, the overwrite bank message (as above) will appear, allowing you to either overwrite the bank or merge the samples with the current bank.

As the programs or samples are being loaded, the following screen will appear to indicate the progress of the conversion.

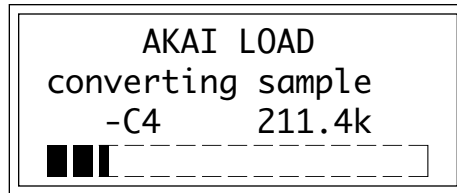

When the conversion is complete, the following screen appears.

★ **Tip:** The cursor buttons can be used to go back to the previous field.

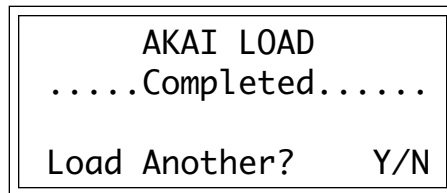

If Yes is selected, the Volume select screen will appear and a new volume, program or sample can be selected. The “Overwrite Bank?” prompt will not appear. Data will be merged with the current bank.

Important Note:

Certain Akai disks have samples and programs stored in separate volumes in order to save space on the disk. If you have an Akai disk using this format, follow these instructions.

- A. Load the volume containing the samples.
- B. Answer “Y” to “Load Another?”.
- C. Load the preset volume.

The above warning only applies to Akai banks with Samples and Programs stored in different Volumes.

13. Press No to exit the submodule. The ESI will return to the Module Identifier.

1. Emax II Import

The Emax II Import function allows you to import Presets, Samples or entire Banks from the Emax II sampler and convert them into an ESI bank. Data is imported into the ESI, from an Emax II formatted SCSI device. Load time will be approximately twice that of the Emax II. There are a few fundamental differences between the Emax II and the ESI. For this reason a few parameters are ignored during the conversion process. In most cases, however, the converted presets and samples should sound and behave very similarly to the originals.

1. **Activate Master/Global module.**
2. **Select Import (0), Emax II Import (1).**

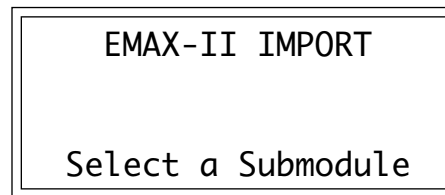

3. **Select the desired import function.** There are three options available. Refer to the chart below.

<p>0. Emax II SCSI Setup Allows the ESI to specify the ID of the Emax II device.</p> <p>1. Emax II Import Options Asks you to confirm before erasing bank data.</p> <p>2. Emax II Load Allows you to browse through the Emax II SCSI device, select the bank, presets or samples to import and start the import process.</p>

An Emax II SCSI device is NOT mounted and accessed like a normal ESI drive (the load and drive buttons will not access the Emax II drive). Instead, it is accessed and operated using the Emax II import menus. Only one Emax or Akai SCSI device can be known to the ESI at any given time.

4. **Press 0 on the keypad to select Emax II SCSI Setup.** This step is necessary for the ESI to recognize the Emax II SCSI device. The display shows:

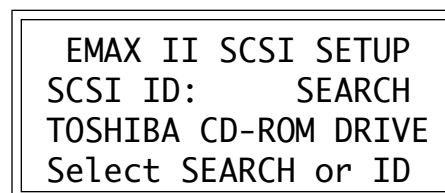

! Caution: Drive 0 cannot be used since the ESI uses this number for the floppy disk.

The setup screen is used to select the SCSI ID of the attached Emax II SCSI device. The SCSI ID may be selected by using the INC/DEC buttons, or by typing the digit (1-7) directly using the keypad. The default choice, "Search", instructs the ESI to search for the first Emax II device in the SCSI chain. Normally you will always use "Search" unless you want to select a specific Emax II device out of several on the SCSI bus. Press ENTER to confirm your choice and return to the option select screen.

- 5. Press 1 to select the Import Options screen.** The following screen will appear. When this function is set to YES, the ESI will issue an extra prompt whenever a load operation is about to destroy the current bank. Press ENTER after selecting your choice.

★ **Tip:** The cursor buttons can be used to go back to the previous field.

```
EMAX II IMPORT

Confirm new bank: Y/N
```

- 6. Press 2 to select the Emax II Load screen.** Immediately after Load is selected, the ESI will attempt to read and verify the Emax II disk using Search mode or using the SCSI ID selected in the SCSI Setup screen.

```
EMAX II LOAD from
B01 Bosendorf8M

Select Bank
```

If an Emax II disk cannot be found, an error message will be generated indicating: "No Emax Drive Found".

- 7. Use the INC/DEC buttons or the Data Entry Control to select the bank to load.** When the correct bank is displayed, press ENTER. The following screen will appear:

```
EMAX II LOAD from
B01 Bosendorf8M
*** ALL PRESETS ***
Select Preset
```

8. Press ENTER to select All Presets in the bank or use the INC/DEC buttons or the Data Entry Control to select a specific preset. Another option is “All Samples” which will only load the samples. Press ENTER. The “Overwrite Bank” warning only appears if “All Presets” or “All Samples” was selected (and “Confirm New Bank” was enabled). If a specific preset was chosen the warning will not appear and the preset (and associated samples) will be merged with the current bank.

```

EMAX II LOAD from
B01 Bosendorf8M
*** ALL PRESETS***
Overwrite Bank?  Y/N
  
```

9. Select Yes to overwrite the current bank or No to merge the data with the current bank. Loading will begin immediately.

```

EMAX II LOAD
Converting sample...
S01          647.0k
■■■|-----|
  
```

Sample Size

- Since samples do not have names in the Emax II, they are imported into the ESI with Sxx appended to the bank name, where xx is the number of the sample. Example: Bosendorf8M_002 Piano.
- Bank and preset names retain their names from Emax II.

```

EMAX II LOAD
.....Completed.....
Load Another?    Y/N
  
```

If Yes is selected, the Bank select screen will appear and a new Bank, Preset or Sample can be selected.

10. Press No to exit the submodule. The ESI will return to the Module Identifier.

5

Sample Management

0. Select Sample	95
1. Load Sample	95
2. Rename Sample	96
3. Erase Sample	97
4. Copy Sample	98
5. Sample Setup	99
6. Place Sample	101
7. Arm Sampling	102
8. Force Sampling	102
9. MIDI Sample Dump	103

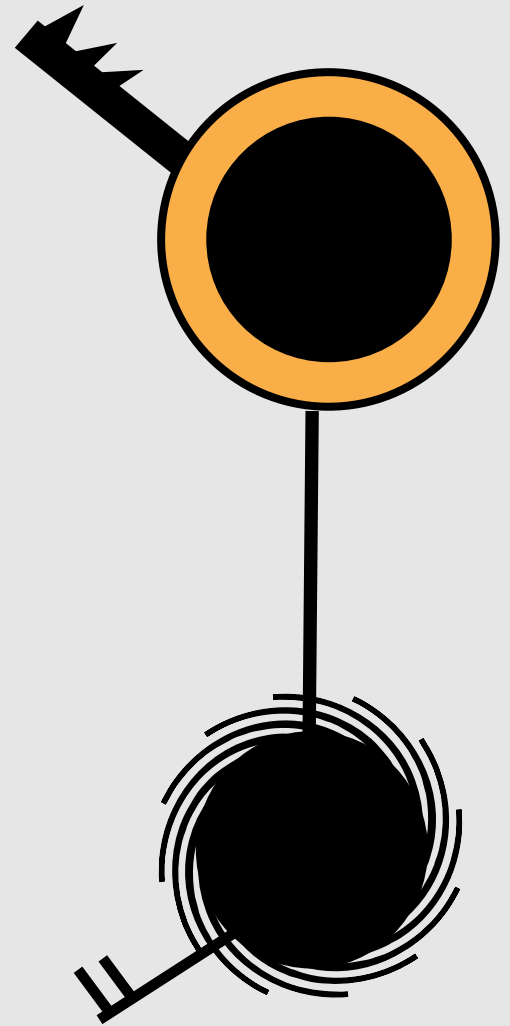

0. Select Sample

This submodule selects a sample for placing on the keyboard, or the sample into which a sound will be recorded.

1. **Activate Sample Management module.**
2. **Select the Select Sample submodule (0).**
3. **Select the desired sample and press ENTER.** As you scroll through non-empty samples, the display will show the sample number, name, sampling rate, sampling length, how many presets use the sample, and whether the sample is stereo, left, or right. And, as you scroll through the samples, they will be playable on the keyboard.

```
SELECT SAMPLE
001 Selected Sample
Stereo          44100Hz
10 Presets     5.3secs
```

1. Load Sample

Samples can be loaded individually from the floppy disk, the internal ZIP disk or external storage devices.

1. **Activate Sample Management module.**
2. **Select Load Sample (1).**
3. **If you wish to select a different drive, press the up cursor button.** If not, proceed to step five.
4. **Select the drive containing the sample to be loaded, then press ENTER.**

```
LOAD SAMPLE from
D1 100MB HD
Select a Drive
```

★ **Tip:** Pressing the Audition button from this submodule auditions the selected sample directly from the hard disk without having to first load it.

5. **Select the bank that contains the sample to be loaded, then press ENTER.**

```
LOAD SAMPLE from
D1 100MB HD
B00 Current Bank
Select a Drive
```

6. **Select the sample to be loaded, then press ENTER.** As you scroll through the samples, the display shows the names of the existing samples, whether stereo or mono, sampling rate, and sample length.

```
LOAD SAMPLE from
001 Current Sample
Stereo          44100Hz
                3.0secs
```

7. **Select the destination sample number into which the source sample will be loaded, then press ENTER.** If you try to overwrite an existing sample, you will be asked if you do want to overwrite. Enter Yes to replace the existing sample, No to cancel the operation.

```
LOAD SAMPLE into
001 Selected Sample
000 Empty Sample
Select Dest Sample
```

8. **If desired, rename the sample.** The Rename Sample screen automatically appears. Choose the characters to be changed with the left and right cursor buttons. Select the desired characters by using the ten key pad, Data Entry Control and keyboard. You can also use the up cursor to insert spaces and the down cursor to delete spaces. (See Sample Management, Rename Sample (2).)
9. **Press ENTER to exit the submodule.** The ESI will return to the Module Identifier.

2. Rename Sample

This submodule allows you to rename any sample.

1. **Activate Sample Management module.**
2. **Select Rename Sample (2).**
3. **Scroll through the samples available for renaming, then press ENTER.**

```
RENAME SAMPLE
001 Current Sample

Select a Sample
```

★ **Tip:** Use the data entry knob or increment/decrement buttons to access the full character set. Most keyboards do not have enough keys to access all available characters.

See the character chart on page 241 for a complete listing of characters.

4. **Rename the sample.** Choose the characters to be changed with the right and left cursor buttons. Select the desired characters by using the ten key pad, Data Entry Control and keyboard. You can also use the up cursor to insert spaces and the down cursor to delete spaces.

```
RENAME SAMPLE
001 Untitled Sample
[0-9]/Encoder/Kybd
```

5. Press ENTER to exit the submodule. The ESI will return to the Module Identifier.

3. Erase Sample

Individual samples can be erased from the bank, and newly created samples in memory can be erased using this function.

1. Activate Sample Management module.
2. Select Erase Sample (3).
3. Select the sample to be erased, then press ENTER.

```
ERASE SAMPLE
001 Current Sample
Select a Sample
```

4. If the sample is stereo, select whether you want to erase the left side, right side, or the entire stereo sample.

```
ERASE SAMPLE
001 Selected Sample
Side:          Stereo
Select L/R/Stereo
```

5. **Decide if you really want to erase the sample.** ESI displays a screen asking if you are sure. If you are sure you want to erase the sample, press the INC/YES button. If you are unsure or change your mind, press the DEC/NO button. ESI returns to the Module Identifier screen.

4. Copy Sample

Samples can be copied to other sample numbers within the same bank.

1. Activate Sample Management module.
2. Select Submodule 4.
3. Select the sample to be copied, then press ENTER.

```
COPY SAMPLE from
001 Current Sample

Select Source Sample
```

4. Select the destination sample number into which the source sample will be copied, then press ENTER. If you try to overwrite an existing sample, you will be asked if you do want to overwrite. Press Yes to replace the existing sample, or No to cancel the operation.

```
COPY SAMPLE to
001 Selected Sample
001 Empty Sample

Select Dest Sample
```

★ **Tip:** Use the Copy Sample function (Sample Management, 5) to paste the clipboard contents to an empty sample location.

5. **Rename the sample.** Choose the characters to be changed with the right and left cursor buttons. Select the desired characters by using the ten key pad, Data Entry Control and keyboard. You can also use the up cursor to insert spaces and the down cursor to delete spaces.
6. **Press ENTER to exit the submodule.** The ESI will return to the Module Identifier.

5. Sample Setup

Use this module to prepare the ESI for sampling. Either the analog inputs or the optional digital input can be sampled.

1. **Activate Sample module.** If you want to sample into the sample number shown on the display, you need do nothing except proceed to the next step. To sample into a different sample number, refer to Select Sample (0).
2. **Select Submodule 5.**
3. **Use the cursor buttons to select one of the following parameters to edit.** Page one displays:

★ **Tip:** The optimum gain level setting for ESI is +00. For high-quality sampling, use an external microphone preamplifier such as the one built into your mixer. The mic preamp in the ESI, while acceptable for some applications, is not designed to be used for ultra-critical sampling.

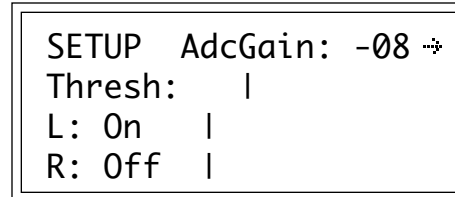

! **Caution:** When sampling in stereo, the Threshold circuit only reads the left channel to initiate sampling.

- **Gain:** Set the analog sample level with the Data Entry Control so that the left and right side meters indicate optimum sampling level. Play the sound to be sampled and observe the bar graph display. The signal level should be set so that the peak bar comes close to the extreme right side without actually reaching it. The gain is adjustable from -16 dB to +40 dB in 4 dB steps. This control has no effect on the digital input.
- **Thresh:** (Threshold) Set the sampling threshold with the Data Entry Control. If you arm sampling (Arm Sampling, 7) and the signal to be sampled exceeds the threshold, sampling will begin.
- **L:** (Left Channel) Line three shows the left input level, record status, and whether on or off. Press Yes or No to enable or disable recording into the left channel. When sampling into one channel only, turn off the other channel to conserve memory.
- **R:** (Right Channel) Line four shows the right input level, record status, and whether on or off. Press Yes or No to enable or disable recording into the right channel. When sampling into one channel only, turn off the other channel to conserve memory.

★ **Tip:** The ESI actually begins sampling just before the threshold is exceeded in order to preserve the attack transient. (Presampling times are set for 12mS at 44.1kHz and 17mS at 22050Hz)

4. **Select page two by pressing the right cursor button.** Page two shows:

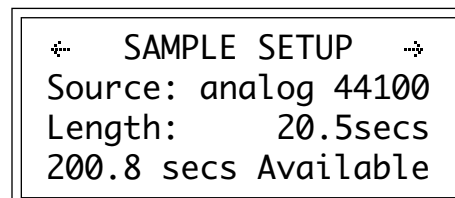

★ **Tip:** If the digital interface card is not installed in the ESI, the digital sampling options will not appear in the display.

- **Source:** Choose between 22050 Hz and 44100 Hz when using the analog inputs. When a digital interface card is installed, three more options, S/PDIF 32K, 44.1K or 48K will appear in the display. When using the digital input, the display setting should match the sample rate of the incoming digital data, otherwise the sample will play back at the wrong pitch.

- **Length:** This allows you to select the amount of sampling (recording) time. The maximum available length depends on the amount of memory available and the sampling rate.
5. **Select page three by pressing the right cursor.** Page three shows the following parameters:

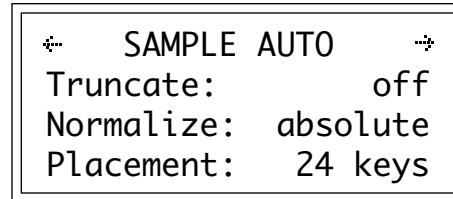

- **Auto Truncate:** automatically truncates the start, end, or both start and end as soon as the sample is taken. Selecting Off disables auto-truncation.
- **Auto Normalize:** increases the amplitude of a sound until the peak amplitude of the loudest sample reaches 100% of full scale. If either Absolute or Relative is selected this is done automatically after the sample is taken. Selecting Off disables auto-normalization. Relative increases the amplitude of stereo samples until the peak sample of either the left or right sample reaches 100% of full level. The relative amplitudes of the left or right samples remain intact. Selecting absolute will increase the amplitude of both the left and right samples to full level. When sampling in mono, selecting absolute or relative makes no difference.
- **Auto Placement:** selects the transposition range in which new samples will be placed. For example, selecting a range of 24 keys places the next sample over a 24 key range with the original pitch in the center of that range. Selecting white keys places each new sample on the next white key, which is useful for sound effects.

Sample Placement Rule - ESI keeps adding samples until the next one won't fit on a 5 octave keyboard - then it starts a new preset. The only exception is "All Keys", which creates a new preset for each sample and places the sample over the entire 88 note range.

6. **Select page four by pressing the right cursor.** Page four shows the monitor through while sampling select screen.

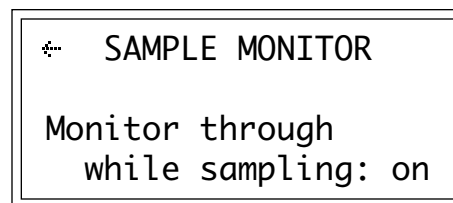

! Caution: *Sample monitoring does not work when sampling in S/PDIF mode.*

- **Monitor Through While Sampling:** Allows you to monitor through the main outputs while sampling is occurring.
7. **Press ENTER to exit the submodule.** The ESI will return to the Module Identifier.

6. Place Sample

Samples in the bank can be placed to cover a particular range of the keyboard.

★ **Tip:** Preset "templates" may be created by placing empty samples and assigning dynamic processing parameters to keyboard locations and then saving the bank.

To use the template, simply load or copy new samples into the empty locations.

1. **Activate Sample Management module.** The display will show the current sample number and name. If this is not the sample you want to place, refer to Sample Management, Select Sample (0).
2. **Select Place Sample (6).**
3. **Select whether you want to place the sample to a primary or secondary zone, then press ENTER.**

```
PLACE SAMPLE
pri
Select pri/sec
```

4. **Select the original pitch of the sample, then press ENTER.** As you select notes, the display will show the samples mapped into the preset.

```
PLACE SAMPLE
pri G1
Select Original Key
```

5. **Select the lowest key of the sample range, then press ENTER.** The display will indicate the preset status (described in step four).

```
PLACE SAMPLE
pri G1 C1
Select Low Key
```

6. **Select the highest key of the sample range, then press ENTER.** The display will indicate the preset status (as described in step four).

```
PLACE SAMPLE
pri G1 C1 to B1
Select High Key
```

7. **If the display asks Overwrite Zone? Press Yes to overwrite, or No to return to the Module Identifier.** If you press Yes to overwrite, any previously assigned samples that fall within the just-specified keyboard zone will be de-assigned from that zone.

7. Arm Sampling

Upon initiating this submodule, the ESI will begin sampling as soon as the sound to be sampled exceeds the threshold set in Sample Setup (5).

1. **Activate the Sample Management module.**
2. **Select Arm Sampling (7).** If you did not select a specific empty sample prior to arming, the first empty sample will be automatically selected. To overwrite an existing sample, erase it first.
3. **Play the sound to be sampled.** When the sound level exceeds the threshold set in 5. Setup, the display will indicate that sampling has begun.
4. **Terminate sampling.** This will occur automatically after reaching the end of the sample length set in Sample Setup (5), or if the ESI runs out of memory. To stop sampling manually, press ESCAPE. In either case, the display will return to the Module Identifier.
5. **Decide if you like the sample.** Play the keyboard. If you don't like the sample, re-arm sampling or force sampling and re-sample before deactivating the module. Once you deactivate the module, the sample will be locked against re-sampling. To erase a locked sample, use Erase Sample (3).

8. Force Sampling

Force Sampling lets you initiate sampling manually as an alternative to threshold-sensitive sampling. This is useful for situations where the signal to be sampled is more or less continuous. Continuous signals greatly complicate the threshold-setting process described in Sample, 5. Setup. Upon initiating this submodule, the ESI will begin sampling immediately.

1. **Activate Sample Management.**
2. **Select Force Sampling (8)** when you are ready to begin sampling. If you did not select a specific empty sample prior to force sampling, the first empty sample will be automatically selected. To overwrite an existing sample, erase it first.
3. **Wait as the signal is sampled.**
4. **Terminate sampling.** This will occur automatically after reaching the end of the sample length (if set in Sample Setup), or if the ESI runs out of memory. To stop sampling manually, press ESCAPE. In any case, the display will return to the Module Identifier.
5. **Decide if you like the sample.** Play the keyboard or press the AUDITION key. If you don't like the sample, re-arm sampling or force sampling again and re-sample BEFORE deactivating the module. Once you deactivate the module, the sample will be protected against re-sampling.

9. MIDI Sample Dump

MIDI Sample Dump allows sample data to be transferred to and from the ESI using the MIDI Sample Dump Standard. This is a way of transferring samples to and from other samplers, although none of the preset parameters are transferred. Sample loop data is retained. If imported samples have loop problems such as “ticks or pops”, the Sample Integrity function (Digital Processing module, Digital Tools I (7), Sample Integrity (7)) may be able to automatically repair them. Otherwise adjust the loop points.

The ESI can transmit sample data with a word size of either 14 or 16 bits (Certain instruments such as the SP-1200 require the use of the 14 bit word size). In addition, for instruments that use 14 bits or less, 14 bit mode transmits data 30% faster.

★ **Tip:** If you are having trouble transferring samples to your computer, try quitting any other programs running simultaneously.

Before initiating MIDI Sample Dump, make sure that the MIDI cables are properly connected. A single MIDI cable (open-loop) is sufficient but the data transfer will be much faster if two MIDI cables are used (closed-loop). The closed-loop allows the two units to handshake and prevents idle time between each data packet. The cables should be connected between the MIDI In and MIDI Out of both units.

! **Caution:** The ESI cannot receive samples to location 000 (clipboard).

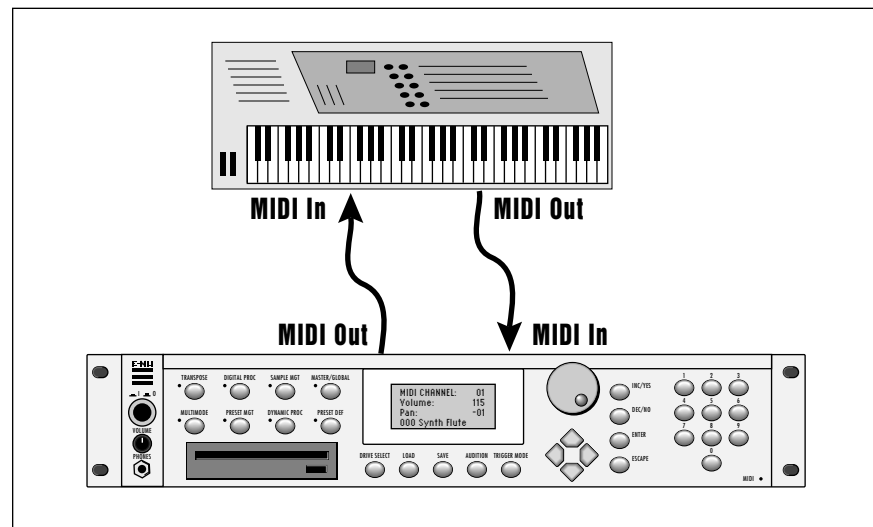

A “closed-loop” connection greatly accelerates MIDI Sample Dumps.

In the Sample Dump Standard and in the ESI, samples are assigned numbers. The ESI sample number and the MIDI sample number remain the same. For example, sample #36 transferred from another device to the ESI will be placed in sample location 36.

! **Caution:** When transferring files to the Emax II, be sure that the sample rates match the Emax or the samples will play back at the wrong pitch. (Use sample rate conversion.)

- When transferring samples to the Emax II, the sample location numbers correspond to sample dump MIDI key numbers. For example, a sample placed in location #60 in the ESI, once transmitted, will be placed on MIDI key #60 (middle C) of the Emax II. If sample location #36 is chosen as a reception location on the ESI, the ESI will request that the sample placed on MIDI key # 36 (C1) of the Emax II be sent.

1. Activate the Sample Management module.
2. Select MIDI Sample Dump (9).
3. Select whether you want to transmit or receive a sample and press ENTER.

```
MIDI SAMPLE DUMP
Direction: Transmit

Select Direction
```

4. Select the word size and press ENTER.

```
MIDI SAMPLE DUMP
Direction: Transmit
Word Size: 16 Bits
Select 14/16 Bits
```

5. Select a sample to be transmitted and press ENTER. If the selected sample is stereo, the ESI will ask you to select which side is to be transmitted.

```
MIDI SAMPLE DUMP
Direction: Transmit
S01 Selected Sample
Select a Sample
```

6. Press ENTER to begin the Sample Dump.

6

Preset Management

- 1. Load Preset 107
- 2. Rename Preset 108
- 3. Erase Preset 109
- 4. Copy Preset 109
- 5. Create Preset 110
- 6. Preset Size 111
- 7. Merge All Presets 111

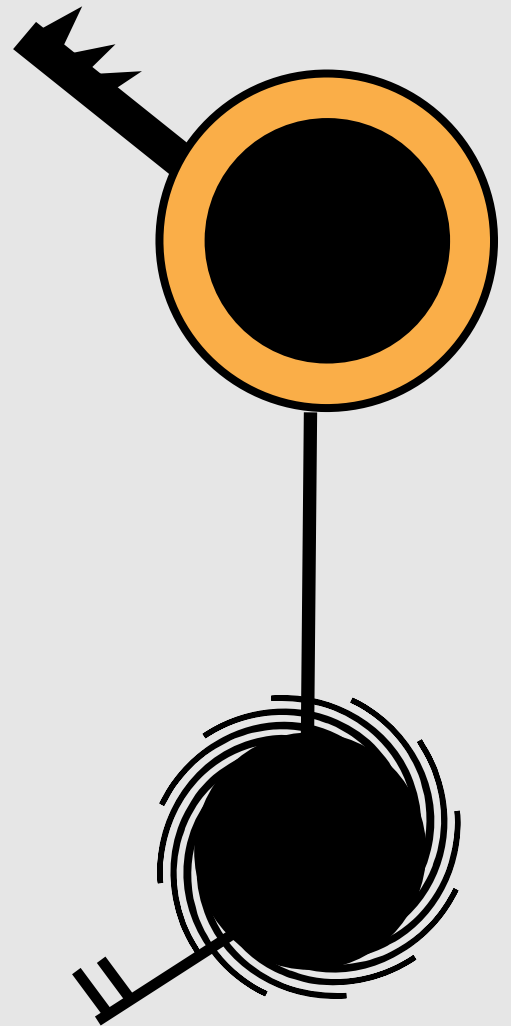

1. Load Preset

A preset, with its samples, can be loaded from the floppy disk, the internal Zip disk or an external storage device.

1. Activate Preset Management module.
2. Select Submodule Load Preset (1).
3. If you wish to select a different drive, move the cursor to the drive number. If not, go to step 5.
4. Select the drive containing the preset to be loaded, then press ENTER.

```
LOAD PRESET from
D1 Main HD

Select a Drive
```

5. Select the bank number that contains the preset to be loaded, then press ENTER.

```
LOAD PRESET from
D1 Main HD
B00 Current Bank

Select a Bank
```

6. Select the preset to be loaded, then press ENTER.

```
LOAD PRESET from
P00 Current Preset

Select Source Preset
```

7. Select the destination preset number into which the source preset will be loaded, then press ENTER. If you try to overwrite an existing preset, you will be asked if you are sure. Enter Yes to replace the existing sample, or No to cancel the operation.

```
LOAD PRESET into
P00 Selected Preset
P00 Empty Preset

Select Dest Preset
```

★ **Tip:** *If you load a preset that uses samples already present in the bank, new copies of the samples will not be loaded. This technique saves a great deal of memory space. However, the samples must be identical, even down to the name, otherwise new samples will be loaded.*

The Rename Preset screen appears on the display.

8. **If desired, rename the preset.** Choose the characters to be changed with the left and right cursor buttons. Select the desired characters by using the ten key pad, data entry control and keyboard. You can also use the up cursor to insert spaces and the down cursor to delete spaces. (See 2. Rename Preset.)
9. **Press ENTER to exit the submodule.** The ESI returns to the Module Identifier.

2. Rename Preset

This submodule allows you to rename any preset in the ESI-32's current bank.

1. **Activate Preset Management module.**
2. **Select Rename Preset (2).**
3. **Scroll through the presets available for renaming. When the display shows the desired preset, press ENTER.**

★ **Tip:** Use the data entry knob or the increment/decrement buttons to access the entire character set. A five octave keyboard does not have enough keys to access all the available characters.

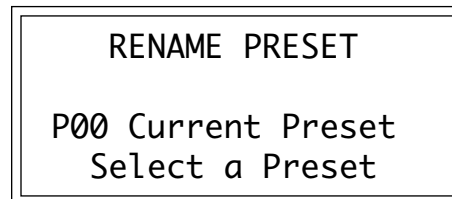

4. **Rename the preset.** Choose the characters to be changed with the left and right cursor buttons. Select the desired characters by using the ten key pad, data entry control, and keyboard. You can also use the up cursor to insert spaces and the down cursor to delete spaces.

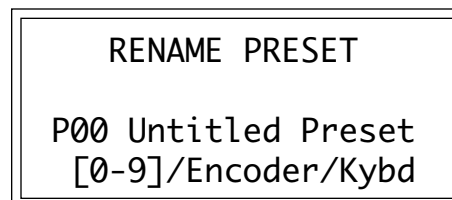

5. **Press ENTER to exit the submodule.** The ESI returns to the Module Identifier.

3. Erase Preset

Individual presets, with or without their samples, can be erased from the bank loaded into the ESI to free up memory space.

1. Activate Preset Management module.
2. Select Submodule Erase Preset (3).
3. Select the preset to be erased, then press ENTER.

★ **Tip:** Erasing a preset won't necessarily free up memory. The samples may be used in other presets which are not erased.

```
ERASE PRESET
P00 Current Preset
Select a Preset
```

4. Press **Yes** to erase the preset, or **No** to cancel the operation. If the preset you are erasing contains samples unique to this preset, you will be asked if you want to Erase Samples Also? Enter Yes to erase the unique samples, or No to erase the preset. In either case the ESI will return to the Module Identifier.

4. Copy Preset

Presets can be copied to other preset numbers within the same bank. This is useful if you want to create variations on a particular preset. For example, you may want to alter the MIDI, velocity, or Dynamic Processing parameters.

1. Activate Preset Management module.
2. Select Copy Preset (4).
3. Select the preset to be copied, then press ENTER.

★ **Tip:** Copying a preset will not make copies of the samples used in the preset.

```
COPY PRESET from
P00 Current Preset
Select Source Preset
```

4. Select the destination preset number into which the source preset will be copied, then press ENTER. If you try to overwrite an existing preset, you will be asked to verify that's what you want to do. Press Yes to replace the existing sample, or No to cancel the operation.

```
COPY PRESET into
P00 Selected Preset
P01 Empty Preset
Select Dest Preset
```

5. **If desired, rename the preset.** Choose the characters to be changed with the left and right cursor buttons. Select the desired characters by using the ten key pad, data entry control and keyboard. You can also use the up cursor to insert spaces and the down cursor to delete spaces.
6. **Press ENTER to exit the submodule.** The ESI will return to the Module Identifier.

5. Create Preset

An empty preset must be initialized by the ESI before it can hold samples. This initialization process is called creating a preset.

1. **Activate Preset Management module.**
2. **Select Submodule Create Preset (5).**
3. **Select the preset to be created, then press ENTER.** If you try to overwrite an existing preset, you will be asked if you want to overwrite. Enter Yes to replace the existing preset, or No to cancel the operation.

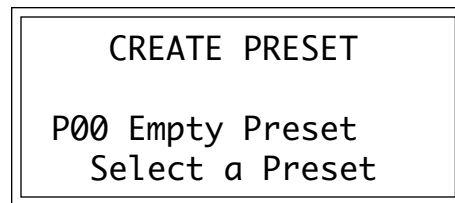

4. **If desired, rename the preset.** Choose the characters to be changed with the left and right cursor buttons. Select the desired characters by using the ten key pad, data entry knob and keyboard. You can also use the up cursor to insert spaces and the down cursor to delete spaces.
5. **Press ENTER** to exit the submodule. The ESI will return to the Module Identifier.

6. Preset Size

How much bank memory does a preset require? Use this function to find out.

1. Activate Preset Management module.
2. Select Preset Size (6).
3. Scroll through the preset numbers and select the preset whose size you want to check. The second line shows the selected preset, the third line the amount of preset memory used (both as a percentage of the total bank memory and as an absolute number of bytes), and the fourth line the amount of sample memory used (both as a percentage of the total bank memory and as an absolute number of bytes).

★ **Tip:** *The percentages of sample memory may add up to considerably more than 100% if the samples are used in several presets.*

```
PRESET SIZE
P00 Current Preset
Preset:  .7%      922
Sample:  9.2% 1543716
```

4. Press ENTER to exit the submodule. The ESI returns to the Module Identifier.

7. Merge All Presets

This function allows you to load all the presets from any bank on any hard disk into the currently loaded bank. This is a very handy feature when you want to create massive, multi preset banks.

1. Activate Preset Management module.
2. Select Merge All Presets (9).
3. If necessary, select the drive from which you wish to load the bank. The ESI will default to the current drive. If you want to choose a different drive, place the cursor under the drive number in line two of the display, select the appropriate drive and press ENTER.

```
MERGE PRESETS from
D1 Main HD

Select a Drive
```

4. Select the bank number you wish to load into the current bank, then press ENTER.

MERGE PRESETS from
D1 Main HD
B01 Selected Bank
Select a Bank

5. **Select the preset number at which the new presets will be placed.** Presets in the selected bank will be added to the current bank starting at the number you specify. Presets will not be overwritten under any circumstances.
6. **Press ENTER to merge the presets.** The display shows the new locations of the presets in the bank, then returns you to the Module Identifier.

MERGE PRESETS into
025 Empty Preset
Select Dest Preset

7

Digital Processing

Background	114
0. Select Sample	121
1. Setup	121
2. Loop	123
3. Truncation	125
4. Copy Region	125
5. Cut Region	127
6. Paste Region	128
7. Digital Tools 1	131
0. Sample Calculator	131
1. Taper	132
2. Gain Change	133
3. Reverse Section	135
4. Stereo <-> Mono	135
5. Left <-> Right	136
6. DC Filter	136
7. Sample Integrity	137
8. Digital Tools 2	138
0. Sample Rate Convert	139
1. Digital Tuning	140
2. Compressor	141
3. Parametric Equalizer	145
4. Time Compression	146
5. Pitch Change	147
6. Transform Multiply	148
7. Doppler/Pan	149
8. Sonic Enhancer	155
9. Undo	156

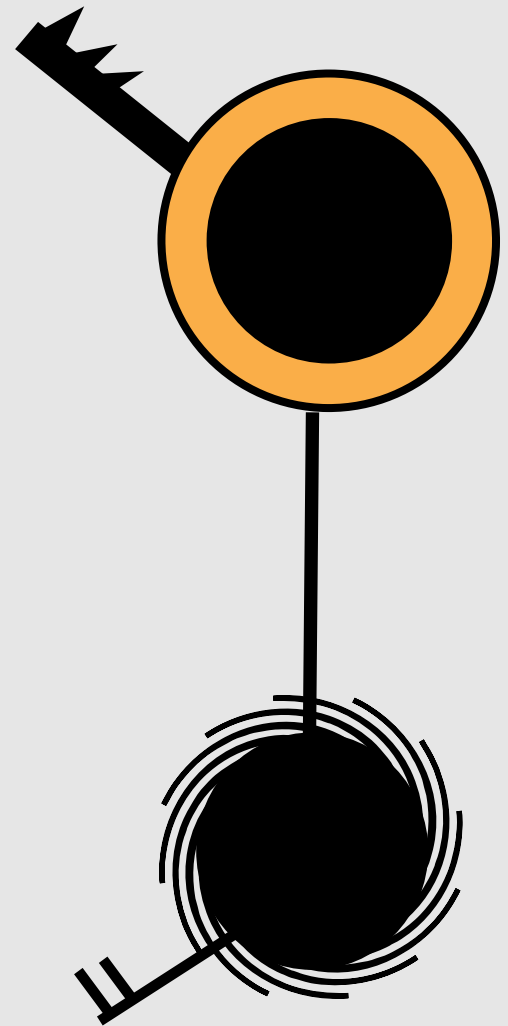

Background: About Looping

Sampling is the process of storing sounds in digital memory. Since each individual sample (not the complete sample, but each element of the sample) requires one memory slot, memory requirements increase if you sample long sounds or use high sampling rates.

How Looping Works

Looping is a technique that can extend a sound's length without using lots of memory. It is based on the fact that many sounds start off with a complex attack transient, then settle down to a comparatively steady sound. Listen carefully to a plucked guitar string. The first part of the sound consists of a complex mixture of pick noise and several harmonics; after a while, the string decays down to a pretty steady repetitive waveform.

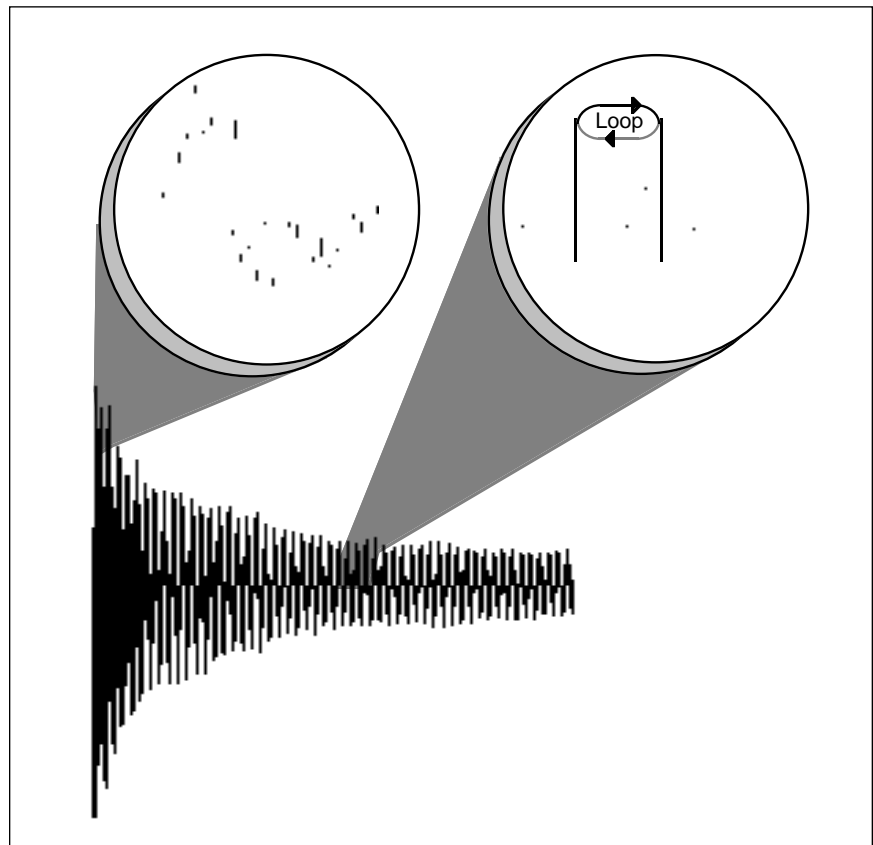

Since the latter part of the waveform is repetitive, there is no need to waste memory sampling several seconds of it. Instead, you can mark off a loop of the repetitive section, and instruct the ESI to play that looped section for as long as the key is held down. After playing to the end of the loop, ESI jumps back to the beginning of the loop and plays through the loop again. This process repeats until you release the key playing back the sample.

Creating Attack & Decay Characteristics for the Looped Portion

One potential problem is that the loop repeats at the same level. This is usually acceptable for sustaining instruments (flute, organ, brass, etc.), but is unacceptable for plucked or struck sounds, which decay over time. Fortunately, the Dynamic Processing module provides a means to shape the attack, sustain, and decay characteristics of a sample. You can create a decay during the looped portion, and simulate pluck or struck sounds.

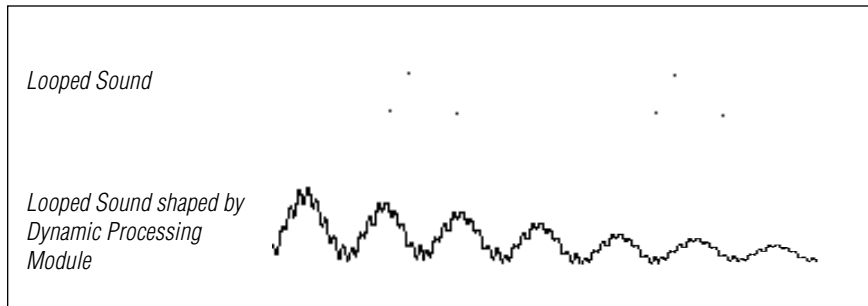

Artificial Decay can be applied to a looped sound.

Loop Compression

The looped section of the sample can be compressed, which “evens out” any changes in amplitude. Changes in amplitude can cause “breathing” effects, thumping or clicks.

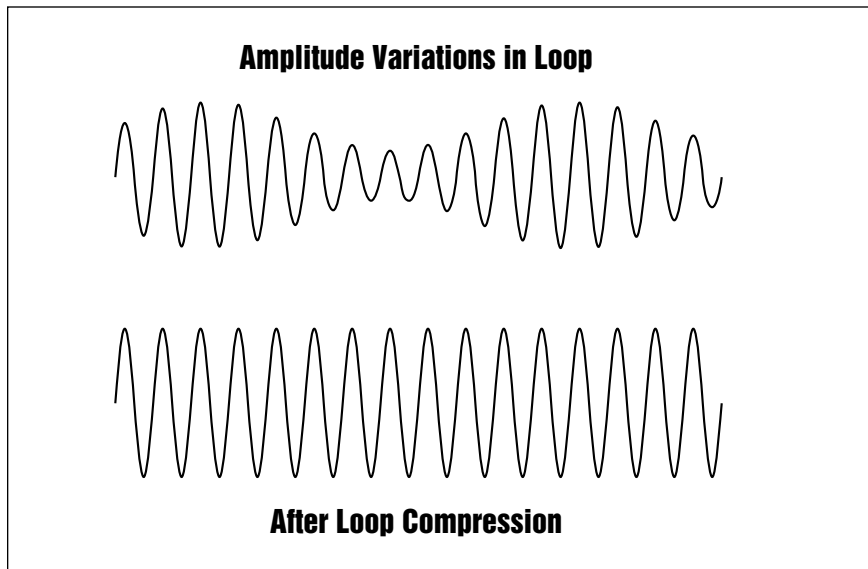

Loop Compression smooths out amplitude variations during the loop period.

Crossfade Looping

The ESI fades between the beginning and end of the loop so that as the end fades out, the beginning fades in. This virtually eliminates the clicks and pops that can occur with other types of looping.

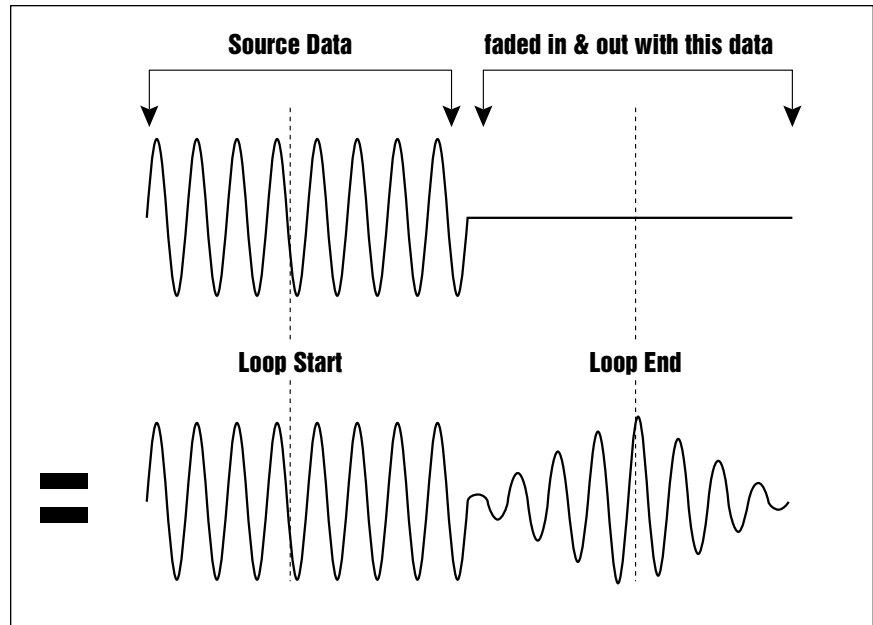

Crossfade Looping takes sound data from around the loop start point and fades it into the sound data around the loop end point so that the data at those loop points is identical. In the example above, a sine wave is crossfaded with silence to illustrate the process.

★ **Tip:** If you notice a timbral shift during the crossfade, try increasing the loop length so that the timbral shift is spread out over more time.

Crossfade looping is very effective with complex ensemble sounds which can be virtually impossible to loop otherwise. In most cases, even the most complex sounds can be looped without any clicks or pops. Bear in mind, however that crossfade looping actually changes the sample data. You may want to keep a backup of your raw sample data in case the loop is not satisfactory.

Background: Cut, Copy, Paste & Undo

Cut, Copy & Paste let you cut out, or make a copy of a segment of a sample and then paste it back in the same sample or in another sample. Imagine a printout of a sample. Now imagine that you have a pair of scissors capable of cutting a piece out of that sample (or a copy of that piece if you don't want to affect the original), as well as a clipboard to neatly hold the cut or copied piece. Now imagine that you can either perfectly insert the clipboard contents at any given point in any sample, or mix the clipboard contents in with any sample, starting at any designated point. The ESI can do all this, and all electronically. The ESI also provides Auto Correlation and optional Crossfade functions that result in seamless transitions between the cut, copied, and pasted parts.

★ **Tip:** The clipboard contents are designated as Sample 00.

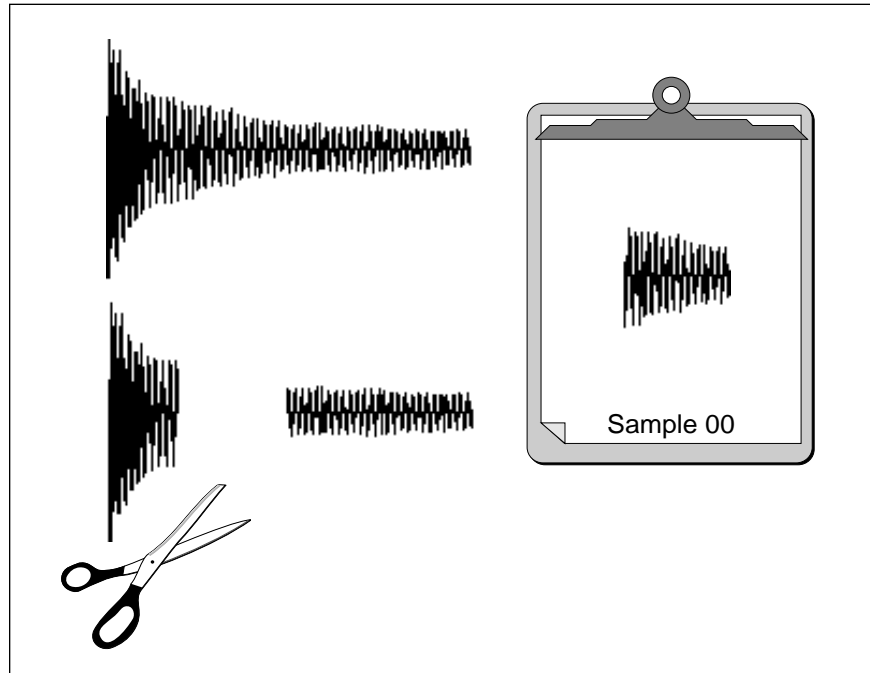

Clipboard Data: The clipboard will retain data until replaced by other data to be copied, cut, or backed up. This occurs with several ESI operations where you want to be able to undo an action that doesn't work out as anticipated. Since clipboard data stays intact when you call up another sample, data can be cut or copied from one sample and pasted to another.

Undo and Redo

During several ESI digital processing operations, such as cut, paste, and sample rate conversion, the ESI automatically backs up the sample being processed and stores this backup in the digital clipboard on the system drive. If you do not like the results of the processing, you can call up the Undo function, and restore the original sample. (Ah, if only life itself were so simple.) Best of all, the processed sample now moves onto the system drive. If you decide you like the processed version better after all, you can actually undo the Undo (Redo).

! **Note** The Undo function only works when there is a hard disk connected to the system.

Insufficient System Drive Memory

If the system runs out of hard disk storage space the display informs you that there is not enough memory to back up a sample. You then have two choices: either free up some additional memory by erasing banks on the system drive, or call up the Undo function (Digital Processing, 9. Undo) and disable the backup process. Of course, if backup is disabled, you cannot undo an operation.

Typical Applications

Typical cut/copy/paste applications would be to splice the beginning of one sample to the end of another, or to mix two samples together to conserve memory. (Do this by copying an entire sample, then pasting it at the beginning of the second sample using the mix option.) You can splice an attack transient on to a synthesizer waveform loop to produce realistic sounds that take up virtually no memory, or take a pop or click out of a sample. Another application is flanging and chorusing. Paste (mix) a sample to itself, offset from the beginning by a few hundred samples or so, to thicken up the sound.

We suggest you practice cut, copy, and paste techniques on a spoken phrase. Samples of political speeches can be particularly amusing when subjected to cut and paste operations.

Background: Auto Correlation

Auto Correlation

First of all, just what does auto correlation mean? Auto correlation simply means to automatically compare and tweak into a complementary or parallel relationship. The computer analyzes the signal around the loop points you have specified and then moves the end point of the loop until it finds a section of the wave that closely matches the section around the start point. Auto correlation may be used again and again with the computer moving the analysis window slightly each time to try to zero in on the optimum loop.

Background: Zero Crossing

Zero Crossing

The term zero crossing refers to the point at which the positive slope of a waveform passes through zero. In many digital processing applications, such as splicing and looping, it is useful to locate zero crossings in order to make glitch-free joins and loops. On some signals, however, a simple zero crossing may not be effective because the signal contains excessive noise or low-level, high-frequency harmonics. In these cases, every few samples may cross through zero. By setting a zero crossing threshold, we can ignore low-level zero crossings and wait for the signal to reach a certain level before choosing the next zero-crossing. Zero crossing threshold sets a level that a signal must exceed before the next zero crossing with a positive slope is selected. The selected zero crossing threshold is used in the Auto-Truncate function in the Sample Management module, Sample Setup (5), or whenever you manually select a zero crossing using the cursor keys.

The diagram on the following page illustrates zero crossing in action. The small x marks the initial position. To move forward through the sound to the next zero crossing, press the right cursor button, as shown in the upper diagram. The ESI will find the first zero crossing on the positive slope after the signal has crossed the designated threshold.

To move backward through the sound to the next zero crossing, as shown in the lower diagram, press the left cursor button. Again, the ESI finds the first zero crossing on the positive slope after the signal has crossed the designated threshold.

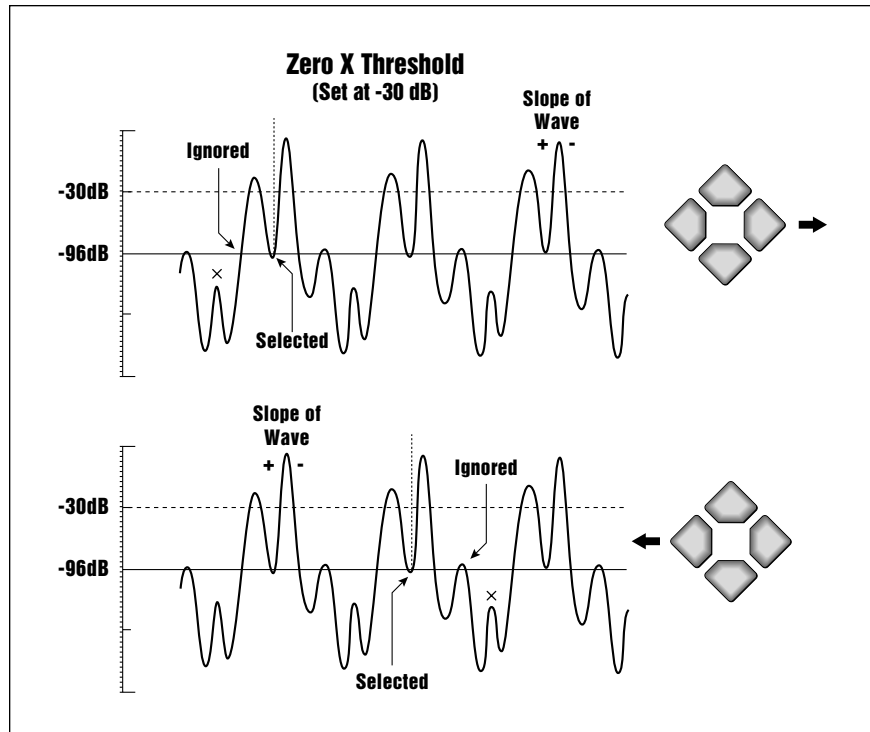

Adjust the zero crossing threshold according to the type of wave you are processing. A setting of -96 dB is most sensitive and can be used for finding the start point of a sound. Settings closer to -30 dB are less sensitive and suited for finding zero-crossings in complex waves.

Background: Scrub Wheel

The Scrub Wheel is an ESI function that allows you to use the pitch wheel in many Digital Processing functions to quickly move through a sound, similar in concept to rocking the reels of a reel-to-reel tape recorder. The scrub wheel makes it easy to locate a particular section of a sound because you are able to hear the sound as you move through it.

To use the scrub wheel, move the pitch wheel of your MIDI keyboard while in a Digital Processing function such as Truncation or Looping. If the pitch wheel is moved slightly forward, the sound will play slowly through its length. If the wheel is pushed forward all the way, the sound will play through faster. If the wheel is moved backwards (towards you) the sound will play backwards through the sound. The scrub wheel operates like the accelerator on your car: the harder you press it, the faster it goes.

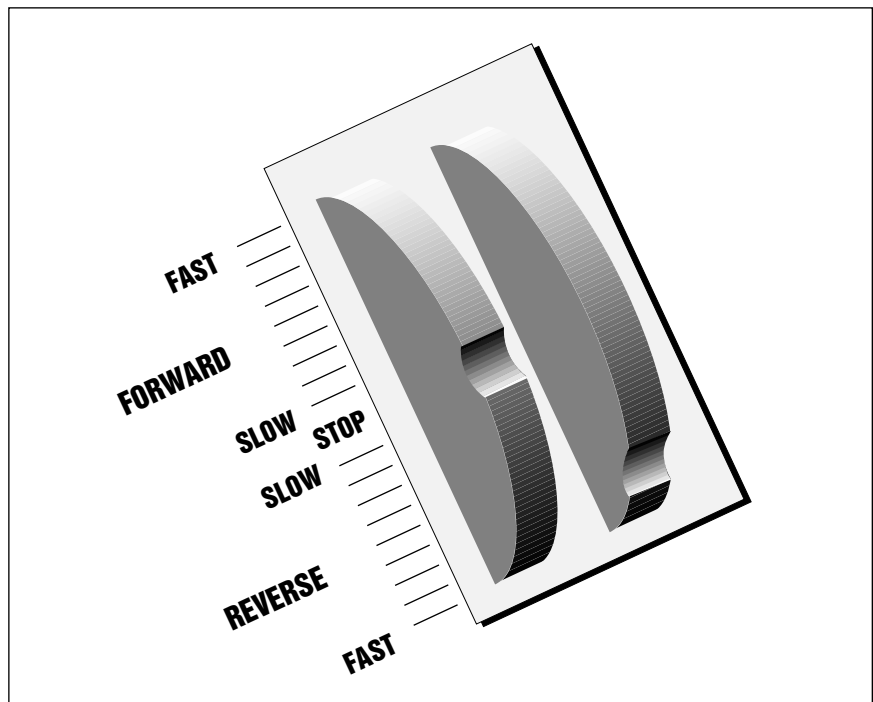

ESI SCRUB WHEEL. Move the wheel slightly to advance slowly through the sound. Move the wheel more to advance quickly through the sound.

0. Select Sample

This function lets you choose the sample you want to process. The resulting current sample remains as designated until you select a different sample, change presets, or load another bank. While in the Digital Processing module, the current sample is placed over the full keyboard range, and all other samples are muted.

1. **Activate Digital Processing module.**
2. **Select Submodule Select Sample (0).**
3. **Select a sample to be processed.** As you scroll through non-empty samples, the display shows the sample number, name, sampling rate, sample length, how many presets use the sample and whether or not the sample is stereo, left or right. As you scroll, each sample is playable on the keyboard over its entire available range.

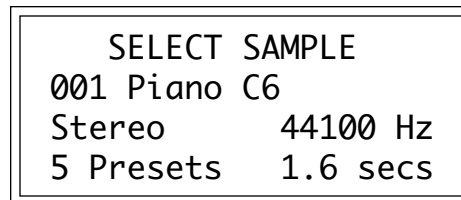

4. **Press ENTER to exit the submodule.** The ESI will return to the Module Identifier.

1. Setup

This submodule lets you turn looping on and off, loop in release on and off and sets various parameters concerning other Digital Processing functions. For more information, see Background: About Looping at the beginning of this section.

! Caution: Samples imported from the EIII having forwards/backwards loops will play back on the ESI, however the loop data will be permanently modified to contain the forwards/backwards sound data. Changing the loop points on imported forwards/backwards loops could have unpredictable results and is not recommended.

1. **Activate Digital Processing module.**
2. **Select Setup (1).**
3. **Select Loop Enable On/Off on line two.**

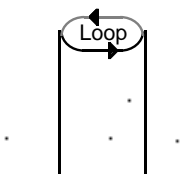

Your choices are:

- **Off:** The loop is disabled and the sample plays as recorded.
- **On:** The sample plays normally until it reaches the end of the loop. It then jumps back to the start point and replays through the loop. Upon reaching the loop end, it again re-plays the loop. This looping process continues for as long as the key is pressed.

4. **Select whether Loop in Release on line three is on or off.** Here are your choices:
 - **Off:** Lifting your finger off a key initiates the release phase of the VCA envelope. If Loop in Release is off, the loop will not continue during the release phase. The portion of the sample after the loop will be played during release. The signal may cut off abruptly after you remove your fingers from the keys if the sample has been truncated after the loop.
 - **On:** With Loop in Release on, the loop will keep playing—even after you lift your finger off the key—for the duration of the VCA release.
5. **Select page two by pressing the right cursor button.** The second page displays the following parameters:

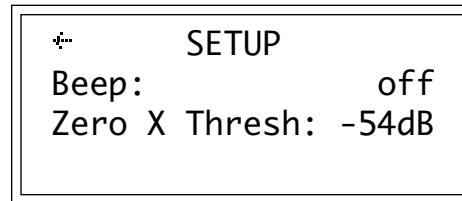

- **Beep:** when on, the ESI gives an audible indication when time intensive digital processing operations are finished.
 - **Zero X Threshold:** Use the Data Entry Control or INC/DEC buttons to select the zero crossing threshold. A setting of -96 dB will be the most sensitive; a setting of -30 dB will be the least sensitive. The selected zero crossing threshold is used in the auto-truncate function or whenever you manually select a zero crossing using the left/right cursor keys. If auto truncate does not seem to be working well, try adjusting the zero crossing threshold.
6. **Press ENTER to exit the submodule.** The ESI will return to the Module Identifier.

2. Loop

If you have a difficult time finding good loop points, the ESI can assist you using the Auto Correlation function. If Auto Correlation doesn't produce acceptable results, the beginning and end of a loop can be crossfaded to help mask loop discontinuities. For more information, see Background: About Looping at the beginning of this section.

1. **Activate Digital Processing module.**
2. **Select the Loop submodule (2).**

★ **Tip:** *The smallest possible loop start point is four samples into the sound.*

LOOP	secs	samples
Start:	1.96	43280
End:	3.54	78162
Size:	1.58	34882

3. **Select the values for the start point on line two and the loop size on line four that give the best looping effect, then press ENTER.**
The left and right cursor will change the start point and/or size so that the loop automatically falls on positive zero crossing points in the waveform.

The sample size equals the difference in samples between the start and end points. These settings interact in the following ways:

- Changing the size automatically changes the end point so that the difference in samples between the start and end points remains equal to the size.
- Changing the start point changes the end point to maintain a constant size.
- Changing the end point changes the size, and the start point remains constant.

! **Caution:** *You cannot Undo the loop settings.*

4. **The display asks if you want to Auto Correlate.** Press YES to Auto Correlate, or NO to proceed directly to step six, Compress Loop. Auto Correlation uses artificial intelligence techniques to choose optimum loop points. Without Auto Correlation, unless you are proficient with sampling techniques, loops will usually have discontinuities between the splice points that can produce annoying ticks, pops and other glitches.

! **Caution:** *If a sample's loop disappears as soon as you have left the Digital Processing module, check to see if the loop function has been disabled in Dynamic Processing-1, Setup.*

LOOP	secs	samples
Start:	1.96	43280
End:	3.54	78162
Auto Correlate?	Y/N	

★ **Tip:** *If a sample ends in a loop, playing it backwards will repeat the loop. The sample will not play back prior to the loop start.*

With Auto Correlation, the ESI looks for loop points, near the ones you chose, that can be spliced together with minimum discontinuity. Occasionally it will be impossible for either you or the ESI to locate a perfect splice point which means the sound cannot be looped, but in most cases you'll find that Auto Correlation, combined with practice and experimentation, can produce very smooth loops.

5. If desired, repeat steps three and four, until the best possible loop results. When you're finished looping, press NO in step four and carry on.

LOOP	secs	samples
Start:	1.96	43280
End:	3.54	78162
Compress Loop? Y/N		

6. The display asks if you want to Compress the Loop. Press Yes to Compress, or No to proceed directly to step seven, Crossfade Loop. Compressing just the loop portion of the sound is yet another way to achieve a smooth sounding loop. Compression "evens out" the changes in level during the loop which are perceived by the listener as amplitude modulation.

7. Select the Crossfade Loop size and type, then press ENTER.

Crossfading means that as one part of the loop fades out, the other fades in. Instead of butt-splicing the end of the loop back to the beginning when forward looping, (or butt-splicing the loop end and start points with forward/backward looping), Crossfade looping smoothly blends the two sounds on either side of the splice. Crossfading virtually eliminates any loop glitches, although there may be level variations instead. These variations are not as noticeable as loop glitches. For more information, see Background: About Looping at the beginning of this section.

! Caution: *If there is not enough disk memory to back up a sample, the ESI will not let you Crossfade unless you disable the backup process in Digital Processing-9, Undo.*

LOOP	secs	samples
Start:	1.96	43280
End:	3.54	78162
Compress Loop? Y/N		

The two types of crossfade looping are:

- **EqPwr: (Equal Power)** This is a weighted crossfade that produces no apparent level shift. It is the most commonly used mode.
- **Linear:** This provides a straight mathematical crossfade. Use Linear mode with samples whose splice points are already close to optimum, such as a sample that has already been Auto Correlated.

When you press ENTER, the sample will be backed up so that crossfade looping can be undone (in Digital Processing, 9. Undo) if you are not happy with the results.

8. Press YES to truncate (discard) all samples after the loop end, or NO to retain the samples after the loop end. If you might want to re-loop the sample later, or try different loop points, press NO. If you are satisfied with the loop, press YES. This will save memory and the ESI will return to the Module Identifier.
9. If you are not satisfied with the resulting crossfade or compression, or didn't really want to truncate those samples past the end point, proceed to Digital Processing, Undo (9).

3. Truncate

The Truncate operation shortens a sample's length by trimming off individual samples from the beginning and/or end. Truncation is most often used to remove unneeded portions of a sample to conserve memory, but it can also be used to change instrument characteristics such as removing the attack from a plucked string note or isolating a particular section of a sample.

1. Activate Digital Processing module.
2. Select Truncate (3).
3. Truncate the desired amount of samples from the start on line two and/or the end on line three, then press ENTER.

★ **Tip:** The left and right cursor keys will change the start and end points so that they fall on positive zero-crossing points in the waveform.

TRUNC	secs	samples
Start:	0.00	00001
End:	2.43	53610
Size:	2.43	53610

The sample size equals the difference in samples between the start and end points. Because of this, these settings interact with the size value on line four in these ways:

- Truncating the **Start** causes the size to change to maintain a constant **End Point**.
- Truncating the **End** causes the size to change to maintain a constant **Start Point**.

! **Caution:** You cannot Undo the truncation settings.

4. If you are not satisfied with the results, or want to compare before and after, proceed to Digital Processing, Undo (9).

4. Copy Region

Portions of a sample can be cut, copied, and pasted to other samples, or into the samples from which they came. The Copy function allows you to duplicate a section of a sample, and store that duplicate in a special part of memory called the clipboard. For more information see the section Background: Cut, Copy, Paste, and Undo.

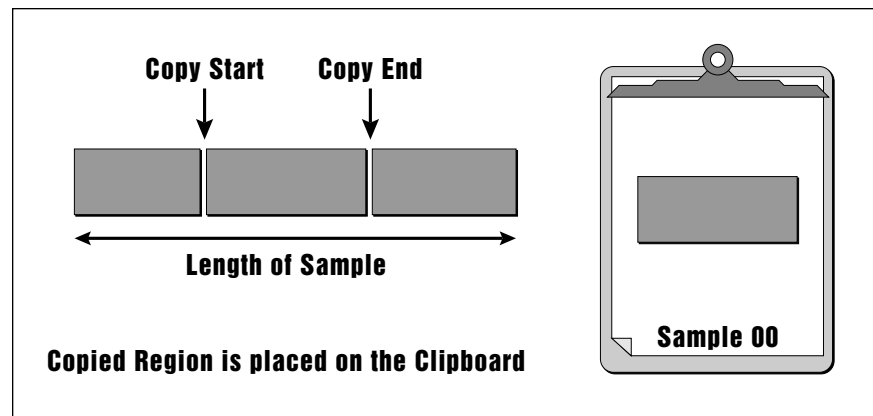

1. Activate Digital Processing module.
2. Select Copy Region (4).
3. Select the sample that you want to copy a section from, then press ENTER.

```

COPY REGION from
001 Selected Sample

Select a Sample

```

4. If the sample is stereo, the following screen will appear. Select the right side, left side, or both sides (stereo), then press ENTER. Otherwise, proceed to the next step.

```

COPY REGION from
001 Selected Sample
Side: Stereo
Select L/R/Stereo

```

5. Specify the start point on line two and end point on line three for the portion of the sample to be copied, then press ENTER. Use the up and down cursor to choose the appropriate line. The size of the portion to be copied on line four will change to reflect changes in the start and end points. Pressing ENTER saves the selected portion in the clipboard. Copying does not affect the original sample. The clipboard will retain this data until replaced by something else to be copied, cut, or backed up.

```

COPY   secs  samples
Start: 0.00   00001
End:   1.61   57881
Size:  1.61   57881

```

5. Cut Region

Portions of a sample can be cut, copied, and pasted to other samples, or the samples from which they came. The Cut function removes a section of a sample, and stores the cut portion in a special part of memory called the clipboard. For more information see the section Background: Cut, Copy, Paste, and Undo.

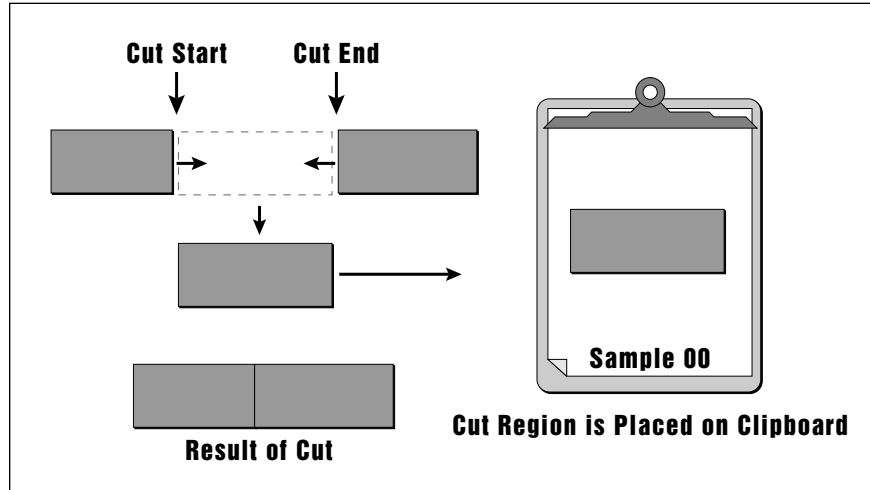

1. Activate Digital Processing module.
2. Select Cut Region (5).
3. Select the sample that you want to cut a section from, then press ENTER.

★ **Tip:** The left and right cursor keys will change the start and end points so that they fall on positive zero-crossing points in the waveform.

```

CUT REGION from
001 Selected Sample

Select a Sample
  
```

4. Specify the start point on line two, and the end point on line three for the portion of the sample to be cut, then press ENTER. Use the up and down cursor to choose the appropriate line. The size of the portion to be cut on line four will change to reflect changes in the start and end points. Cutting affects the original sample by deleting the part being cut. The clipboard will retain this data until replaced by something else to be copied or cut.

```

CUT      secs  samples
Start:  0.00  00001
End:    1.61  57881
Size:   1.61  57881
  
```

5. If you are not satisfied with the resulting cut, proceed to Digital Processing, Undo (9).

6. Paste Region

Portions of a sample can be cut, copied, and pasted to other samples, or the samples from which they came. Paste takes the clipboard contents (which holds the last cut or copied sample segment) and either inserts it in a sample at a specified point, or mixes it with a sample starting at a specified point. For more information see the section Background: Cut, Copy, Paste, and Undo.

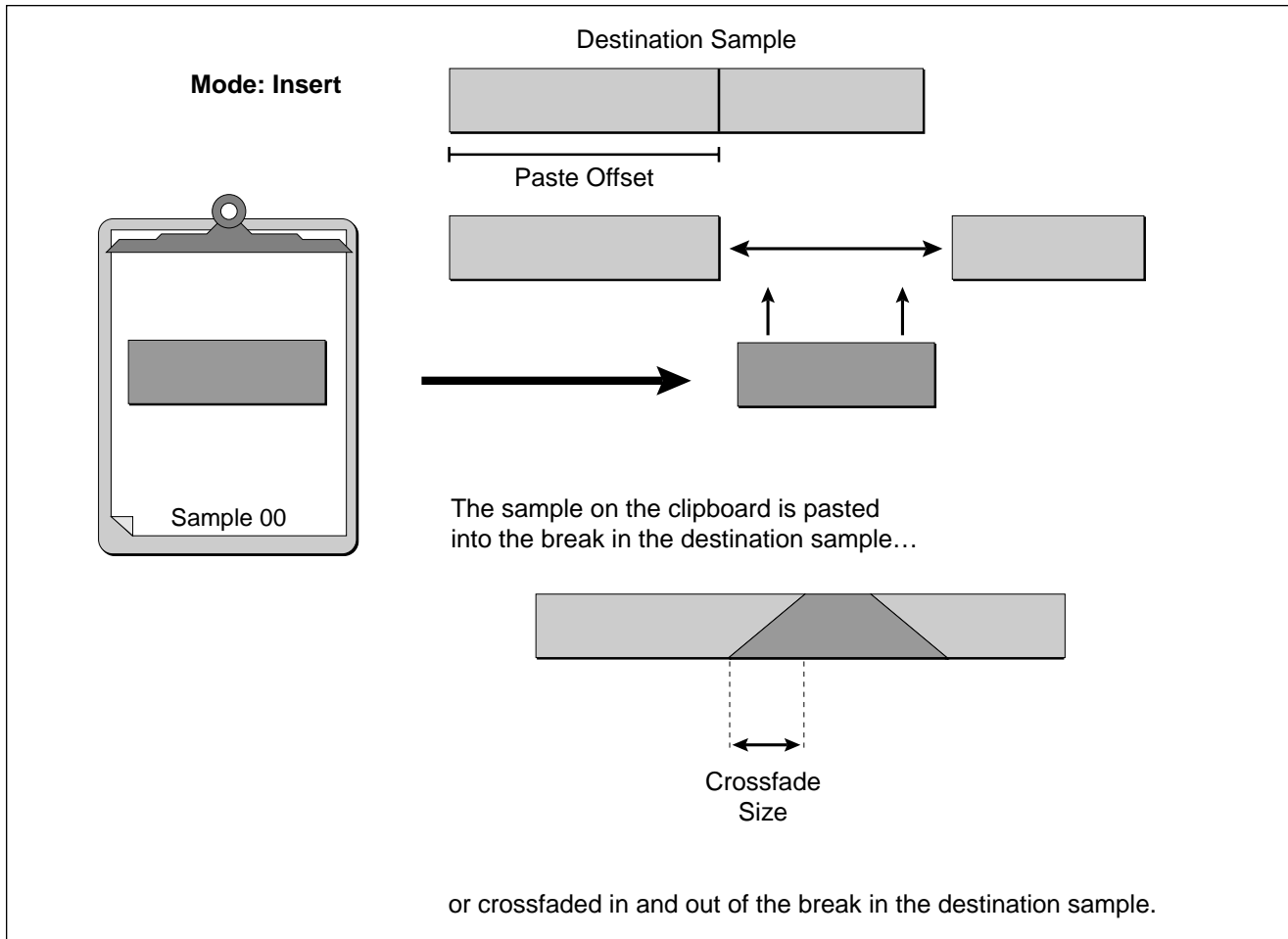

1. Activate Digital Processing module.
2. Select Paste Region (6).
3. Select the sample that you want to paste the clipboard contents into, then press ENTER.

★ **Tip:** The left and right cursor keys will change the Paste Offset point so that it falls on positive zero-crossing point in the waveform.

PASTE REGION into
S00 Selected Sample
Select Dest Sample

4. Specify the paste point on line two as an offset (in samples) relative to the beginning of the sample, then press ENTER.

```
PASTE secs samples
Offset 0.00 000001

Select Location
```

5. **Select the Paste Mode.** Choose whether to insert or mix the clipboard contents at the point selected in step three, then press ENTER.

★ **Tip:** Use the Copy Sample function (Sample Management, 5) to paste the clipboard contents to an empty sample location.

```
PASTE secs samples
Offset 1.06 33943
Mode: Insert
Select Insert/Mix
```

Insert opens up a space in the sample into which the clipboard contents fit. Equal Power Mix and Linear Mix combine the clipboard contents with existing samples, starting at the point selected in step three. Normally, you will always use Equal Power. Use Linear Mix when the signals are very similar or when Equal Power causes a gain in amplitude.

6. **If you chose insert in step five, proceed to the next step. If you chose mix in step five, select the level of the contents to be mixed, then press ENTER.** 100% indicates a replacement.

```
PASTE secs samples
Offset 1.06 33943
Mode:Equal Power Mix
Source Amount: 100%
```

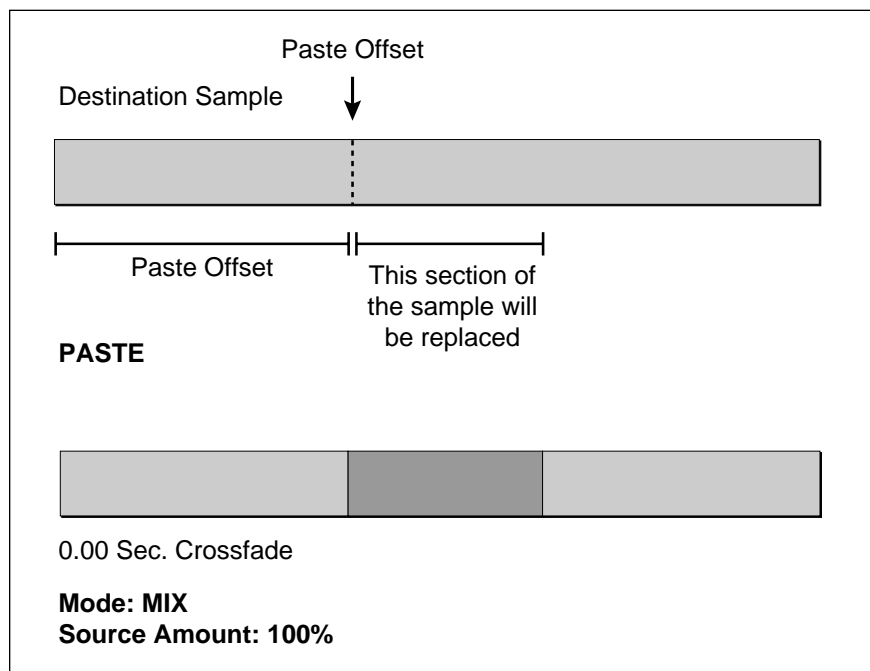

7. Select the Crossfade size and type, then press ENTER.

XFADE	secs	samples
Size:	0.00	00000
Type:		Linear

Crossfading minimizes glitches from pasting dissimilar sections of samples. When creating time delay and flanging/chorusing effects, do not select any Xfade time for best results. Your choices are:

- **Equal Power:** This is a weighted crossfade that produces no apparent level shift. It is the most commonly used mode.
- **Linear:** This provides a straight mathematical crossfade.

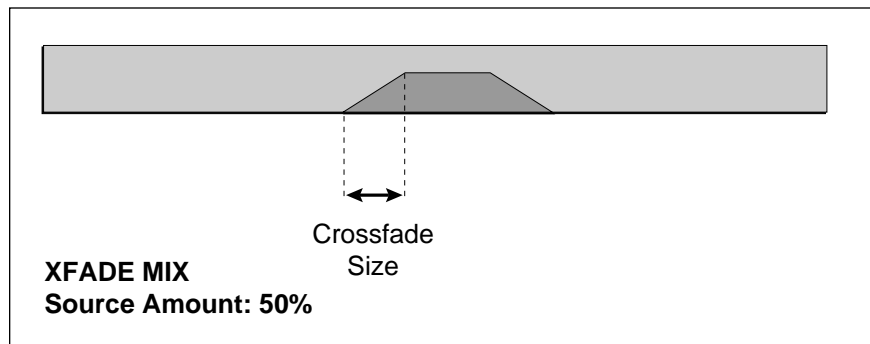
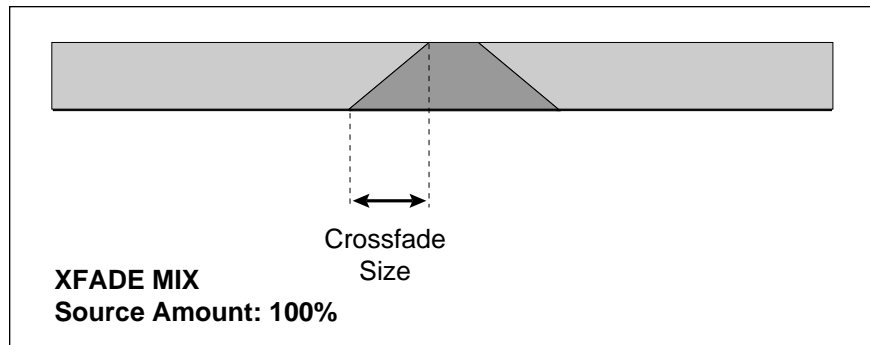

8. Press ENTER to perform the paste.

9. If you are not satisfied with the paste, or want to compare before and after, proceed to Digital Processing, Undo (9).

7. Digital Tools I

This submodule contains several additional numbered functions. These are extremely useful utilities for manipulating samples. The following is a short description of each function.

0. **Sample Calculator:** Calculates and displays the optimum pitch to sample rate ratios for single cycle loops at the desired pitch.
1. **Taper:** Adds a fade-in and or fade-out to the sample, thus smoothing out samples with abrupt beginnings or endings.
2. **Gain Change:** Alters the level of all or a part of a sample.
3. **Reverse:** Reverses all or part of a sample.
4. **Stereo <-> Mono:** Converts a stereo sample to mono or a mono sample to stereo.
5. **Left <-> Right:** Swaps sides if the current sample is stereo or moves a mono sample to the other side.
6. **DC Filter:** Removes the DC component from a sample, centering the waveform around the zero axis.
7. **Sample Integrity:** Samples may occasionally have slight looping problems due to data corruption of the sample header file. This function remedies the problem by reconstructing the sample header.

0. Sample Calculator

Use the Sample Calculator to compute the sample rate for a perfect single cycle loop. You provide the pitch and sample rate, the Single Cycle field displays the single cycle value based on the information you provide. Use the Single Cycle value to adjust the loop length. This provides an “in tune” single cycle loop.

1. **Activate Digital Processing module.**
2. **Select Digital Tools I (7), Sample Calculator (0).** The display will reveal the Sample Calculator.

! Caution: *If the Single Cycle value shown is not an integer number, adjust the Sample Rate until it is an integer. Then use the Sample Rate Convert function (Digital Tools II, submodule SampleRate Convert (0) to convert the sample to the new rate.*

<p>SAMPLE CALCULATOR Pitch: 440Hz A3 Sample Rate: 44001Hz Single Cycle: 100.00</p>

3. **Enter the pitch of the sample using either the keyboard or Data Entry Control.** The number of samples in a single cycle changes for each note.
4. **Select sample rate on line three. Use the INC/DEC buttons to change the value.** The number of samples in a single cycle changes for each sample rate.

To adjust the loop refer to the Digital Processing, submodule Loop (2).

1. Taper

Taper allows you to create an artificial decay on percussion samples in which the original decay is absent, create an artificial fast attack on a sound (such as a bowed violin with a slow attack), or clean up background noise when editing dialog. The diagram above shows the effect of Taper gain and attenuation on a sample using the Linear and Exp 3 curves.

★ **Tip:** Taper the ends of sounds before splicing to avoid clicks or pops at the splice point.

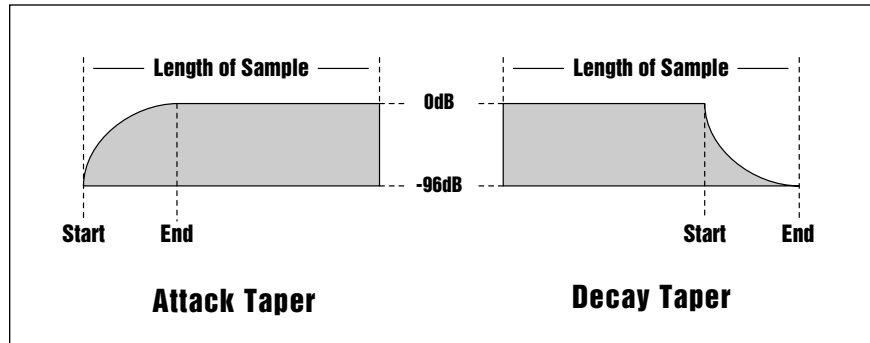

1. Activate Digital Processing module.
2. Select Digital Tools I (7), Taper (2).
3. If the current sample is stereo, the following screen appears. Select the left side, right side, or both sides (stereo), then press ENTER. Otherwise, proceed to the next step.

```

TAPER
Side: Stereo
Select L/R/Stereo
    
```

4. Select the desired taper points and press ENTER. The display will show the current taper points, which will be the endpoints of the current sample.

★ **Tip:** The left and right cursor buttons will change the start and end points so that they fall on positive zero-crossing points in the waveform.

```

TAPER  secs  samples
Start: 0.00  000000
End:    3.13  137873
Size:   3.13  137873
    
```

```

TAPER
Start Amount: 0.00dB
End Amount:   -96dB
Type:         Linear
    
```

! Caution: When using Taper Gain, avoid clipping the signal with too much gain. The Normalize display in the Gain Change submodule can be used as a sample headroom indicator.

5. Move the cursor to the parameter to be selected, select the desired value(s) with the Data Entry Control and press ENTER. The sample will be tapered between the selected start and end points with the type of curve selected.

- **Start Amount:** is the amount of gain or attenuation applied at the start of the taper and is variable from -96 to +96 dB.
- **End Amount:** is the amount of gain or attenuation applied at the end of the taper and is also variable from -96 to +96 dB.
- **Type:** selects the type of taper curve: Linear, Exp 1, Exp 2, Exp 3. Graphs of these curves are shown below.

★ **Tip:** Percussive and Plucked sounds are notoriously hard to loop. By Taper boosting the entire plucked sound +3 dB to +5 dB), using the default Start and End settings, a very natural kind of compression is applied which makes looping these sounds much easier.

Start with 0 dB and Taper up to +3 dB. As the sound decays, the gain will be boosted, leaving the attack of the sound unaffected.

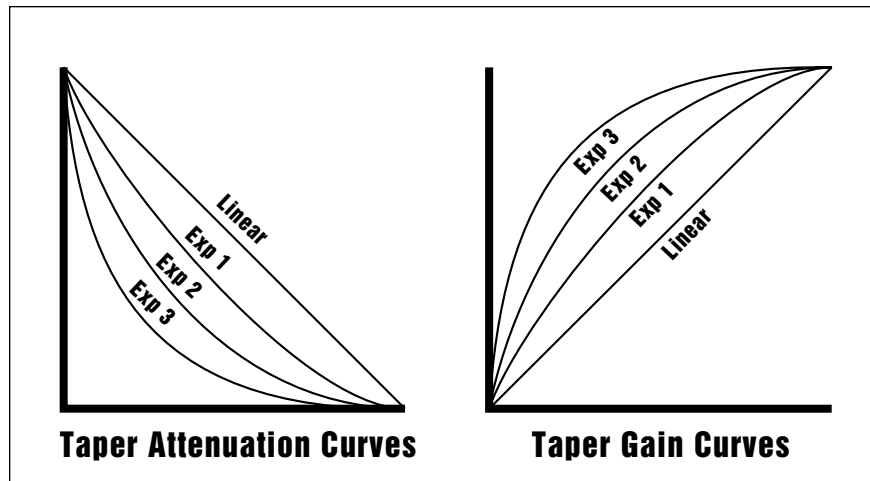

6. If you are not satisfied with the resulting taper, or want to compare before and after, proceed to Digital Processing, Undo (9).

2. Gain Change

Gain Change alters the level of all or part of a sample.

1. Activate Digital Processing module.
2. Select Digital Tools I (7), Change Gain (2).
3. If the current sample is stereo, the following screen will appear. Select the left side, right side, or both sides (stereo), then press ENTER. Otherwise, proceed to the next step.

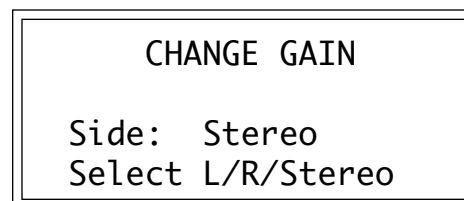

4. Select the desired gain change points and press ENTER.

GAIN	secs	samples
Start:	0.00	000000
End:	3.13	137873
Size:	3.13	137873

The display will show the current gain change points, which are the end points of the current sample. After pressing ENTER, the ESI computes the amount of gain change necessary to achieve normalization or 0 dB headroom.

5. Select the desired boost or cut with the Data Entry Control and press ENTER. The amount of boost or cut is variable from -96 dB to +96 dB in 1 dB steps.

★ **Tip:** Boosting the gain more than the amount specified in Normalize will result in clipping which may or may not be audible. Use the Normalize display as a headroom indicator to limit the maximum amount of gain.

GAIN CHANGE	
Amount:	+00dB
	+04dB = Normalize

6. Move the cursor to the parameter(s) to be adjusted, select the desired value(s) with the Data Entry Control and press ENTER. The sample will be tapered between the selected start and end points with the type of curve selected.

FADE	secs	samples
Size:	0.00	000000
Type:		Linear

- **Size:** sets the size of the crossfade between no gain change and gain change. This is variable from 0 to 1/2 the sample size.
 - **Type:** selects the type of gain curve: Linear, Exp 1, Exp 2, Exp 3.
7. If you are not satisfied with the resulting gain change, or want to compare before and after, proceed to Digital Processing, Undo (9).

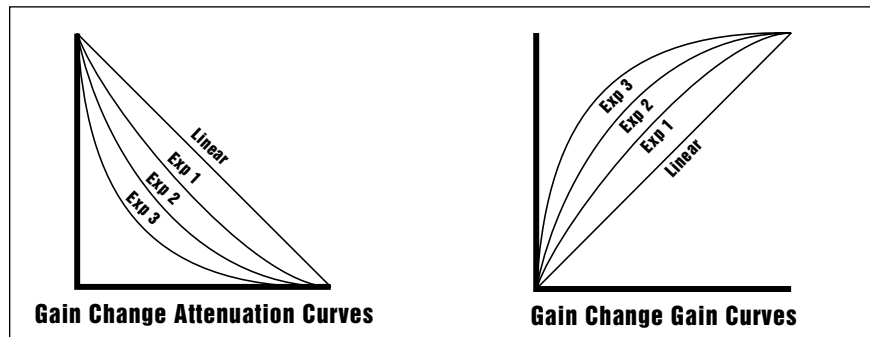

3. Reverse Section

Reverses all or part of a sample.

1. Activate Digital Processing module.
2. Select Digital Tools I (7), Reverse Section (3).
3. If the current sample is stereo, the following screen appears. Select the left side, right side, or both sides (stereo), then press ENTER. Otherwise, proceed to the next step.

```
REVERSE SECTION

Side: Stereo
Select L/R/Stereo
```

4. Select the desired section of the sample to be reversed and press ENTER.

★ **Tip:** The left and right cursor keys will change the start and end points so that they fall on positive zero-crossing points in the waveform.

```
REVERSE secs samples
Start: 0.00 000000
End: 3.13 137873
Size: 3.13 137873
```

The display shows the current points at which the sound will be reversed, which will be the endpoints of the current sample. The sample will be reversed between the selected start and end points.

5. If you are not satisfied with the reversal, or want to compare before and after, proceed to Digital Processing, Undo (9).

4. Stereo <-> Mono

Converts a stereo sample to mono or a mono sample to stereo. Mono samples are created using the left side of a stereo sample. Stereo samples are created by simply duplicating the mono sample on the other side.

1. Activate Digital Processing module.
2. Select Digital Tools I (7), Stereo <-> Mono (4). The display asks if you want to convert the current sample to stereo (if it is mono) or to mono (if it is stereo).

```
STEREO <-> MONO

Convert to Mono?
```

3. Press YES to convert the sample to stereo or mono or NO to exit the submodule. The ESI will return to the Module Identifier.

5. Left <-> Right

Swaps sides if the current sample is stereo or moves a mono sample to the other side.

1. Activate Digital Processing module.
2. Select Digital Tools I (7), Swap Sides (5). The display asks if you want to swap sides if the current sample is stereo, or move the sample to the other side if it is in mono.

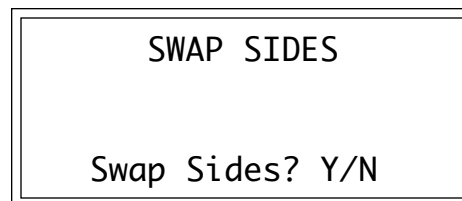

3. Press YES to swap or change sides or NO to exit the submodule. The ESI returns to the Module Identifier.

6. DC Filter

Removes the DC component from a sample, centering the waveform around the zero axis.

1. Activate Digital Processing module.
2. Select Digital Tools I (7), DC Filter (6). The ESI immediately begins scanning the current sample for DC offset.

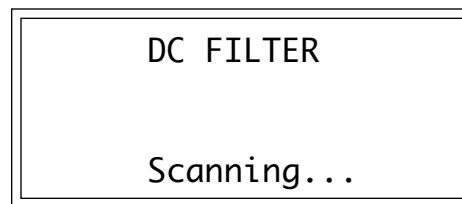

When scanning is complete, the display will show:

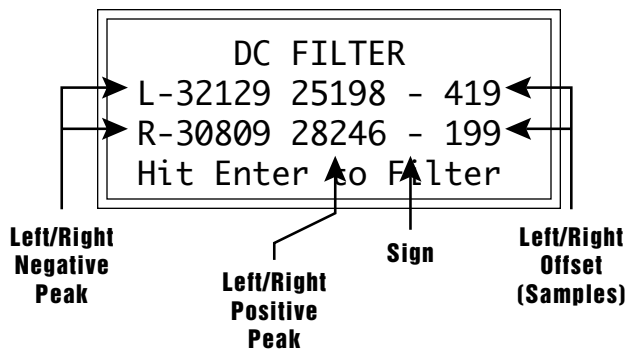

The positive and negative peaks are expressed in 16-bit samples. The offset is the DC bias present in the sample. Full scale is the maximum level of a 16-bit number.

+32767	=	Full Scale (positive)
-32768	=	Full Scale (negative)

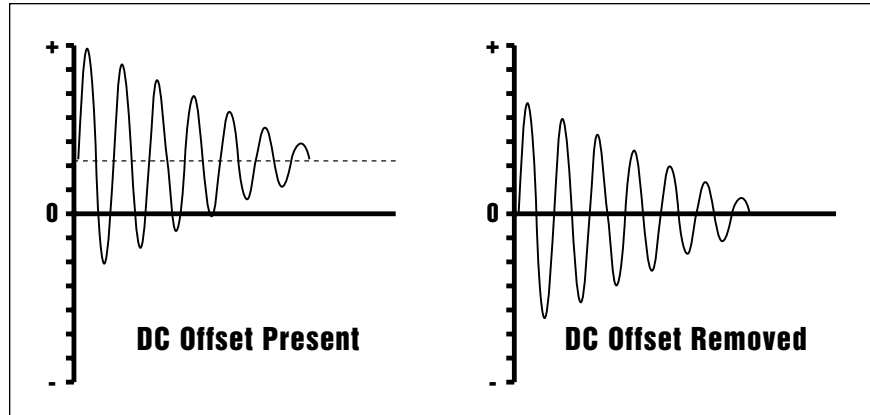

3. Press **ENTER** to filter DC offset or **Escape** to exit the submodule. The ESI will return to the Module Identifier.

7. Sample Integrity

Samples may occasionally have slight looping problems due to data corruption of the sample header file. This function remedies the problem by reconstructing the sample header. If a sample has been corrupted, the display may show an error message such as “Mono Start Zero!”.

1. Activate **Digital Processing** module.
2. Select **Digital Tools I (7), Sample Integrity (7)**. The display shows:

<p style="text-align: center;">FIX SAMPLES</p> <p style="text-align: center;">Fix all samples? Y/N</p>
--

3. Press **ENTER** to fix samples in the bank. The ESI will only modify loops which are in need of repair.

8. Digital Tools II

This submodule contains eight more digital functions. These are extremely useful utilities for manipulating samples. Following is a short description of each function.

0. **Sample Rate Convert:** Converts the sample to any sample rate between 7000 Hz and 50000 Hz.
1. **Digital Tuning:** Digitally re-tunes a sample within a range of ± 1 octave.
2. **Compressor:** The compressor dynamically changes the gain of the sample based on the amplitude envelope of the sample. This is a non-realtime implementation of a full featured dynamic range compressor.
3. **Parametric EQ (Equalizer):** This is a digital (non real-time) implementation of a one band parametric EQ, with +12 dB boost or -48 dB of cut and completely variable frequency and bandwidth controls.
4. **Time Compression:** This function changes the length of a sample without changing the pitch. This can be very useful for fitting samples to the beat of a song or fitting dialog into a spot. Samples can be compressed or expanded in length from 50% to 200%.
5. **Pitch Change:** This function changes the pitch of a sample without changing the time relationships between events. The maximum amount of pitch change is ± 1200 cents (\pm one octave).
6. **Transform Multiply:** This function merges two sounds together in a unique way which can create many strange and beautiful sonic textures. Frequencies common to the original sounds are accentuated while uncommon frequencies are discarded.
7. **Doppler/Pan:** This unique function allows you to dramatically move a sound from front to back and side to side in a 2-D space. Several pre-computed paths as well as 10 user-definable paths are available.
8. **Sonic Enhancer:** The Sonic Enhancer adds brilliance and "cut" to a sample making it stand out in a mix.

0. Sample Rate Convert

Sample Rate Conversion can be used for saving memory, increasing the upward transposition range of a sound, or exactly matching the sample rate to a multiple of the sounds frequency for perfect single cycle loop (use the sample calculator).

Sampling at a high sample rate provides better frequency response than sampling at a slower rate, but uses up more memory. If you need to reclaim some of that memory, and are willing to trade off sample frequency response, samples can be converted from a higher rate to a lower one. Use your ear to compare sounds at the two sample rates. If you can't tell the difference, use the lower rate.

1. **Activate Digital Processing module.**
2. **Select Digital Tools II (8), Sample Rate Convert (0).** The display will show the current sample rate and sample size.

SAMPLE RATE CVT	f:0
Rate:	22050Hz
Size:	107220
Loop Size:	5035.00

3. **Select the new sample rate and press ENTER.** The display updates the sample size to reflect the new sample rate. The Loop Size display shows the size of the resulting loop. If a fractional number is shown, you may want to adjust the sample rate until the loop size is an integer, otherwise the loop size will be slightly altered by the conversion process.

The “f” in the upper right corner indicates the reconstruction filter that is used in the resampling process. Higher numbers indicate more interpolation filtering (cutting more high frequencies). There are six interpolation filter frequencies (0-5).

Tip: By performing successive sample rate conversions with lower reconstruction filter numbers, the automatic filtering system can be subverted and the sample can be kept brighter.

4. **If you are not satisfied with the resulting sample rate conversion, or want to compare before and after, proceed to Digital Processing, Undo (9).**

1. Digital Tuning

Digital Tuning allows you to change the pitch of a sound in order to splice or combine it with another sound of a different pitch. Try offsetting the pitch of a copied sample by a few cents, then combine it with the original for flange and chorus effects. If a sample is slightly out of tune, it is usually better to fix the sample once and for all, rather than re-tune the sample when it is placed on the keyboard.

★ **Tip:** Re-tuning pitch downward increases the sample size. Re-tuning pitch upwards decreases the sample size.

1. Activate Digital Processing module.

2. Select **Digital Tools II (8)**, **Digital Tuning (1)**. The display will show the current tuning offset, sample size and loop size.

3. Select the desired amount of re-tuning, then press **ENTER**. The display will update the sample size to reflect the new tuning. The loop size display shows the size of the resulting loop. If a fractional number is shown, listen to the resulting loop carefully. The loop size will be slightly altered by the conversion process.

The “f” in the upper right corner indicates the reconstruction filter that will be used in the resampling process. Higher numbers indicate more interpolation filtering (cutting more high frequencies). There are six interpolation filter frequencies (0-5).

Tip: By performing successive digital tunings with lower reconstruction filter numbers, the automatic filtering system can be subverted and the sample can be kept brighter.

DIGITAL TUNING	f:0
Tuning:	+1200 cents
Size:	209882
Loop Size:	69930.00

4. If you are not satisfied with the resulting re-tuning, or want to compare before and after, proceed to **Digital Processing, Undo (9)**.

2. Compressor

The Digital Compressor is a digital (non-realtime) equivalent of an analog dynamic range compressor with attack and release times, adjustable threshold, adjustable ratio, and three modes of operation.

1. Activate Digital Processing module.
2. Select Digital Tools II (8), Digital Compressor (2).
3. If the current sample is stereo, the following screen will appear. Select the left side, right side, or both sides (stereo), then press ENTER. Otherwise proceed to the next step.

```
DIGITAL COMPRESSOR
Side: Stereo
Select L/R/Stereo
```

4. Select the desired area to be compressed and press ENTER.

! Caution: The gain setting which is in effect at the end point of the selected section will remain in effect for the rest of the sample. This is done to prevent nasty pops and phase problems caused by an abrupt transition back to the normal gain.

```
COMP.  secs  samples
Start: 0.00  000000
End:    3.13  137873
Size:   3.13  137873
```

The display will show the current points of the sample to be compressed, which will be the start and end points of the current sample. Select the section of the sample to be compressed, then press ENTER.

```
COMPRESSOR Mode: rms
Thres:   center 100%
Ratio:           4.00:1
Atk:999ms Rel:999ms
```

5. Position the cursor under the desired parameter and adjust the value using the Data Entry Control.

Mode: RMS or Peak.

RMS - Root-mean-square or an “average of the magnitude of the signal”. RMS represents the “true” energy content of a signal.

Peak - Uses the peak amplitude of a signal to determine the amplitude. The peak amplitude is a meaningful measurement in a digital system because of the 96 db (16-bit) headroom limit.

Threshold: Above, Center, Below, %

Above - Only signal levels above the threshold % will be affected by the compressor.

Center - Signal levels above as well as below the threshold % will be affected by the compressor.

Below - Only signal levels below the threshold % will be affected by the compressor.

% - Determines the threshold level as a percentage of 100% of 16 bits.

Compression Ratio: Variable from 0.01 : 1 to 99.8 : 1.

Determines the amount of compression or expansion. Ratios of greater than 1:1 compress dynamic range. Ratios of less than 1:1 expand dynamic range.

Compression - Reduces the amount of dynamic range. Levels remain more constant.

Expansion - Expands the amount of dynamic range. Changes in level are exaggerated.

Atk (Attack Time)

Determines how quickly the gain will be turned down. The attack time is variable from 0 to 999 milliseconds.

Rel (Release Time)

Determines how quickly the gain will be turned up. The release time is variable from 0 to 999 milliseconds.

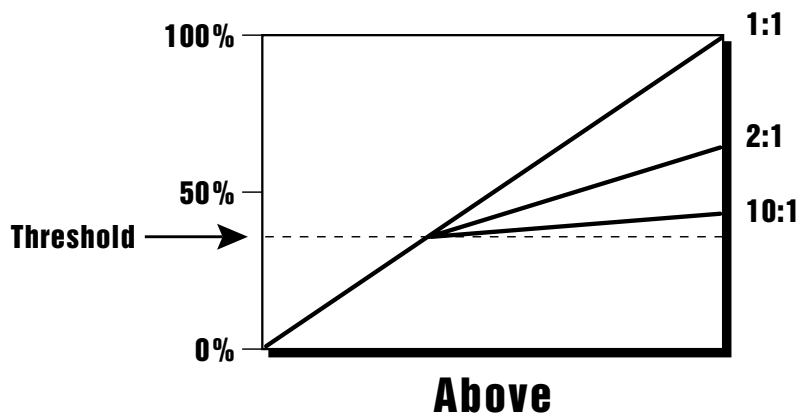

Only signal levels **ABOVE** the Threshold % will be affected by the compressor.

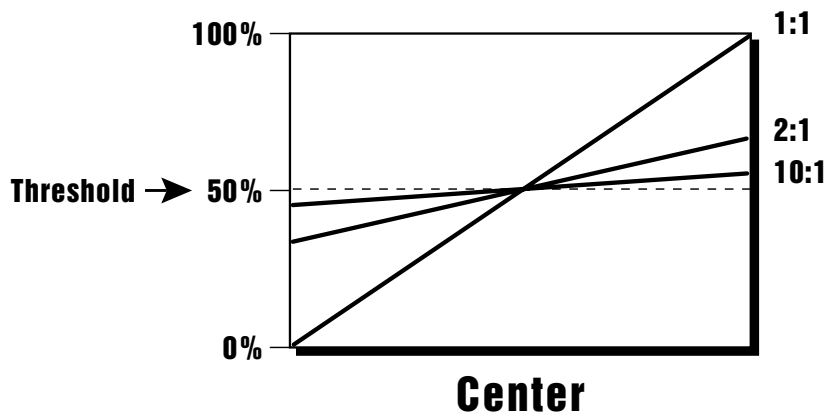

Signal levels **ABOVE** as well as **BELOW** the Threshold % will be affected by the compressor.

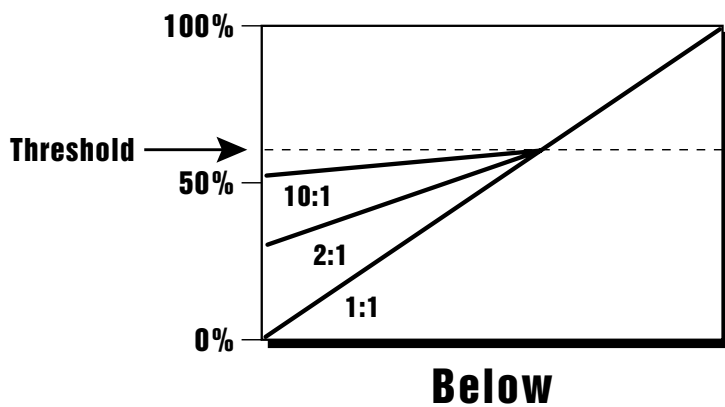

Only signal levels **BELOW** the Threshold % will be affected by the compressor.

Using the Digital Compressor

Limiters

A limiter prevents the signal from exceeding a preset level (threshold). Signal levels below the threshold will be unaffected.

Set the controls as follows:

Threshold: Above, XX% (where XX is the limit point).

Ratio: >10:1

Attack Time: 1 mS

Release Time: approximately 100 mS

Musical Compression (e.g. Guitar)

This type of compression tries to keep the volume constant, generally to increase the sustain of the instrument. As the note dies away, the compressor will boost the level in an effort to keep the level constant.

Set the controls as follows:

Threshold: Center, XX% (where XX is the compression point).

Ratio: approximately 4:1

Attack Time: 1 mS to 100 mS

Release Time: > 100 mS

Noise Reduction

Noise reduction will reduce low levels even further in the assumption that low levels are noise.

Set the controls as follows:

Threshold: Below, approx. 30%

Ratio: approximately 0.7:1

Attack Time: approximately 100 mS

Release Time: approximately 100 mS

3. Parametric Equalizer

Parametric EQ allows you adjust the individual parameters of the filter. Boost and Cut controls “how much” of the signal will be boosted or cut. Center Frequency sets the center frequency to be boosted or cut, and the Bandwidth control sets the width of the band to be boosted or cut. The three parameters are diagrammed below.

The parametric equalizer is a digital (non real-time) equivalent of an analog equalizer with +12 db of boost and a whopping -48 dB of cut. Accurate center frequency and bandwidth controls are precise and exceptionally wide range.

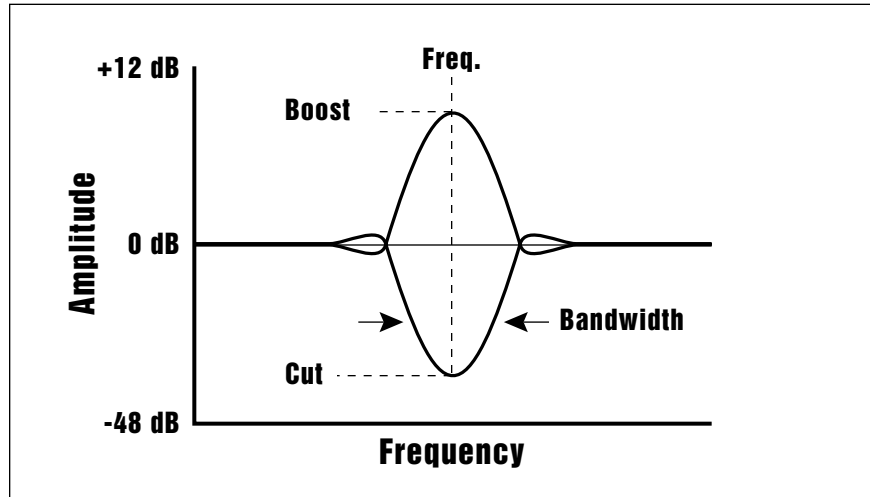

1. Activate Digital Processing module.
2. Select Digital Tools II (8), Parametric EQ (3).
3. If the current sample is stereo, the following screen will appear. Select the left side, right side, or both sides (stereo), then press ENTER. Otherwise proceed to the next step.

PARAMETRIC EQ	
Side:	Stereo
	Select L/R/Stereo

4. Select the desired points to be EQ'ed and press ENTER.

EQ	secs	samples
Start:	0.00	000000
End:	3.13	137873
Size:	3.13	137873

★ **Tip:** The left and right cursor buttons will change the start and end points so that they fall on positive zero-crossing points in the waveform. This will minimize clicks in the sound when processing only part of a sample.

The display shows the current points of the sample to be equalized, which will be the start and end points of the current sample. Select the section of sample to be EQ'ed, then press ENTER.

5. Move the cursor to the parameter(s) to be adjusted, select the desired values with the Data Entry Control, and press ENTER.

★ **Tip:** A standard analog parametric equalizer may be useful in order to locate the frequencies which need EQ. The digital EQ can then be used to actually filter the sample with ultra-low noise and phase linear response.

PARAMETRIC EQ	
Gain:	+12dB
Center Freq:	1000Hz
Bandwidth:	50Hz

6. If you are not satisfied with the resulting EQ or want to compare before and after, proceed to Digital Processing, 9. Undo.

4. Time Compression

This function allows you to change the length of a sample without changing the pitch. This is a useful function for fitting samples to the beat of a song or fitting dialog into a spot. Samples can be compressed or expanded in length from 50% to 200%.

1. Activate Digital Processing module.
2. Select Digital Tools II (8), Time Compression (4). The display will show the current time compression ratio and signal type.

Time Compression Ratio:

200% = Double Length

50% = Half Length

TIME COMPRESSION	
Ratio:	110%
Type:	broad
Length:	3.1=> 3.4s

3. Select the desired time compression (or expansion) ratio. The lower line of the display changes to show the resulting length of the compressed or expanded sample.
4. Select the general type of sample to be processed. Refer to the chart on the following page for a list and brief description of the sample types.
5. If you are not satisfied with the resulting Time Compression or want to compare before and after, proceed to Digital Processing, Undo (9).

★ **Tip:** If you are not happy with the results of Time Compression, simply Undo, then choose another algorithm.

5. Pitch Change

This function is the exact opposite of Time Compression in that it changes the pitch of a sample without changing the time. The maximum amount of pitch change is ± 1200 cents (\pm one octave).

1. **Activate Digital Processing module.**
2. **Select Digital Tools II (8), Pitch Change (5).** The display will show the current amount of pitch change in cents and signal type. (1 cent = 1/100 of a semitone.)

PITCH CHANGE	
Tune:	+ 52cts
Type:	mid-2

3. **Select the desired pitch change amount.** The lower line of the display changes to show the resulting length of the compressed or expanded sample.
4. **Select the general type of sample to be processed.**
The choices are:

deep	Predominant deep bass (to 14 Hz)
bass	Predominant bass (to 20 Hz)
mid-1	Average source material
mid-2	Average source material (high-mids)
high	Source material with high frequencies
tight	Maintains time accuracy - Drum loops
broad	Low bass energy but critical highs
broad-smooth	Both high & low frequencies - Smooth output
difficult	Inharmonic or broadband material
noisy	Non-pitched - Sound Effects, etc.
tight-smooth	Preserves rhythmic accuracy. Use small ratios.
x-smooth	Preserves rhythmic accuracy. Use small ratios.

5. **If you are not satisfied with the resulting Pitch Change or want to compare before and after, proceed to Digital Processing, Undo (9).**

★ **Tip:** *Transform Multiplication can take quite a bit of time with longer samples. Begin your experiments with short samples or even sample attacks as these will give good initial results.*

Transform Multiplication Ideas:

- *Try using the same sound for both samples.*
- *Splicing silence to the beginnings or ends of short samples can change the spectral characteristics of the result.*
- *Using speech as one of the sources, it is possible to “speak from within” violins, bassoons, cymbals, etc.*

! Note *Transform Multiplication needs extra memory to perform its thousands of calculations. If you get a memory error, load just the two samples into the ESI and try again.*

6. Transform Multiply

This unique function merges two sounds together in a way that accentuates frequencies common to both sounds while discarding uncommon frequencies. Because of this characteristic, Transform Multiplication tends to work best with sounds that are harmonically rich. Using this function is easy. Just pick two sounds and multiply! Although you have to wait to hear the results, Transform Multiplication can produce many strange and beautiful textures unattainable by any other means. The length of the resulting sample will be equal to that of the current sample.

1. **Activate Digital Processing module.**
2. **Select submodule Select Sample (0).**
3. **Select the first source sample to be multiplied, then press Enter.**
4. **Select Digital Tools II (8), Transform Multiplication (6).** The display shows:

```

TRANSFORM MULTIPLY
072 Flute C4
L   0.1secs 29312Hz
Select Second Sample
  
```

5. **Select the second sample to be multiplied using the INC/DEC buttons, the Data Entry Control or the keypad.** The third line of the display shows the characteristics of the second sample (L, R, or L/R), the length and the sample rate.
6. **Press ENTER to select the second sample.** The display shows the time required to process the samples.

```

TRANSFORM MULTIPLY

Will take 26 mins..
Continue? Y/N
  
```

7. **Press Yes to start the computation or No to return to the Module Identifier.**
8. **If you are not satisfied with the resulting Transform Multiplication or want to compare before and after, proceed to Digital Processing, Undo (9).**

7. Doppler/Pan

This function allows you to apply either a pre-programmed or user-definable sound path to a mono sample or the left side of a stereo sample. The result is a stereo sample with pitch shifted and left-right gains adjusted according to the path. The sound can move dramatically forward-back and left-right in a 2-D space in front of the listener. Several pre-programmed paths and up to 10 user-definable paths are available with up to 26 points per path.

1. Activate Digital Processing module.

2. Select **Digital Tools II (8), Doppler/Pan (7)**. The display will show the current path, level threshold and Doppler status.

DOPPLER/PAN 	
Path:	small circle
Doppler:	on
Threshold:	-44dB

3. Select the desired **Path for the Doppler/Pan**. The lower line of the display changes to show the resulting length of the compressed or expanded sample. The choices are:

Fast-by (L->R)	Sound moves left to right quickly
Slow-by (L->R)	Sound moves left to right slowly
Far->Near (fast)	Sound moves far away to close quickly
Far->Near (slow)	Sound moves far away to close slowly
Near->Far (fast)	Sound moves close to far away quickly
Near->Far (slow)	Sound moves close to far away slowly
Small Circle	Sound moves in an 8 ft. circle in front
Medium Circle	Sound moves in a 50 ft. circle in front of you
Large Circle	Sound moves in a 120 ft. circle in front of you
Huge Circle	Sound moves in a 250 ft. circle in front of you
Random 1	Sound moves in a random path in front of you
Random 2	Sound moves in a different random path
User Path 1-10	Sound moves in a user-programmed path

The pre-computed paths are always initially scaled to the length of the sample, although this time may be changed using the Duration parameter (read on). The 10 user-defined paths are saved along with the bank so that they may be applied to other samples over multiple-user sessions.

4. Turn **Doppler Pitch Shift On or Off**. With Doppler turned Off, only the panning effect will be enabled.

★ **Tip:** Pressing the right cursor button from the initial screen selects the Path Management screen described on the following page.

5. **Set the amplitude Threshold.** Certain sound paths may take the sound source very far away from the listener, resulting in little or no resulting amplitude. The “Threshold” parameter specifies the maximum amplitude attenuation of the original sample that will ever occur. By setting this parameter appropriately, you can ensure that the resulting sample will produce at least a minimum amplitude output at every point along the path. A setting of 0 dB would prevent any amplitude changes whatsoever. A setting of -96dB would not prevent the sound from completely fading away at some points.
6. **Press ENTER to continue.** The Path Parameters screen (shown below) will appear.

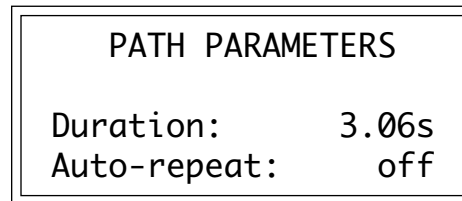

7. **Select a shorter Path Duration if desired.** The Path Duration allows you to scale the path time so that it runs to completion in a time shorter than the length of the sample. The default value is always the length of the sample. If auto-repeat is off (see below), the sound will remain at the end of the path until the sample is complete.
8. **Turn Auto-repeat On or Off as desired.** Auto-repeat causes the path to repeat if the end is reached before the sample has completely played. Auto-repeat will only occur if path duration is set to a value less than the sample length. The default setting for Auto-repeat is Off.
9. **Press ENTER to begin processing the sample.** The display shows:

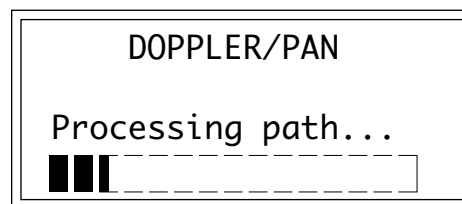

10. If you are not satisfied with the resulting Doppler/Pan or want to compare before and after, use Digital Processing, Undo (9).

Path Management Screen

Sound paths may optionally be edited and processed in a number of ways. If the right cursor is pressed in the initial Doppler/Pan screen, the Path Manager screen appears:

```
⌘ PATH MANAGER
Path:   user path 1
Function: reverse
```

! Note *The pre-programmed paths must first be copied to a user location before they can be edited.*

The path may be selected in this screen as well. “Function” specifies the path processing function. The available functions are:

- **Edit** ----- edit a user path
- **Copy** ----- copy a path into one of the user paths
- **Reverse** -- cause a user path to be played in reverse
- **Flip** ----- flip a user path around the X-axis
- **Offset** ----- apply an x and/or y offset to a user path
- **Clear** ----- initialize a user path

Copy Path

This function copies a pre-programmed or user path to a user path. When Copy Path is selected, the following screen will appear:

```
COPY PATH
From:  medium circle
To   :   user path 1
Select Source Path
```

Select the source and destination paths, then press ENTER to copy the path.

Reverse Path

This function reverses the direction of a user path. When Reverse Path is selected, the following screen will appear:

```
REVERSE PATH
Reversing path:
user path 2
Are You Sure? Y/N
```

Flip Path

This function causes a user path to be mirrored around the “X” axis so that points that were to the left side of the listener are now on the right and vice-versa. Selecting Flip Path causes the following screen to appear:

```
FLIP PATH
Flipping path:
user path 2
Are You Sure? Y/N
```

Offset Path

This function allows you to add an offset to the left and right path points, moving the entire path closer or farther, or more to the left or right. The X offset adds to all X values; the Y offset adds to all Y values in the path. The resulting sums are clipped to the coordinate system (shown under Path Edit). When Offset Path is selected, the following screen will appear:

```
OFFSET PATH
X offset:    +265
Y offset:    + 0
Enter X offset
```

★ **Tip:** The “X” offset varies the L-R position. The “Y” offset varies the front-back position.

Press ENTER to add the offsets to the path.

Clear Path

This function clears all x,y and time values to zero. If this “zero” path were used to process a sample, the sound would not move. When Clear Path is selected, the following screen will appear:

```
CLEAR PATH
Clearing path:
user path 2
Are You Sure? Y/N
```

Press YES to clear the path.

Path Edit

The Edit Path function allows you to specify up to 26 points and times for each of the ten available paths. When Path Edit is selected, the following screen will appear:

```
PATH EDIT
0 0.00s [-999,500]
1 0.52s [+ 0, 0]
2 0.86s [+224,999]
```

Each line of this screen is a point in the path, specified by [X,Y] position (numbers inside the [brackets]) and a time, in seconds. The point number is the left-most number of each line and may not be edited. By using the INC/DEC buttons or the Data Entry Control while the cursor is under a point number, the path edit screen can be scrolled to display and edit all 26 points.

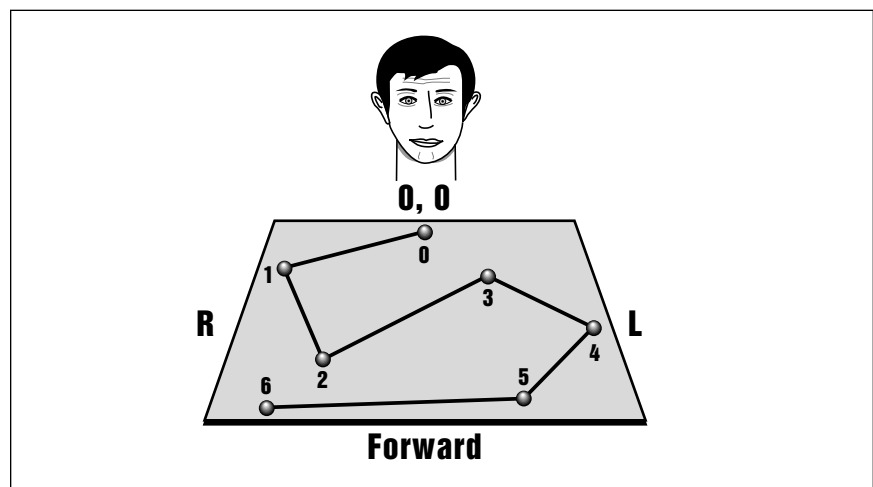

Up to 26 points defining the sound location can be specified. Each point has an associated time parameter to move the sound from the previous point.

X-Y coordinates are specified in 10ths of feet. X values range from -999 (-99.9 feet) to +999 (99.9 feet), Y values from 0 to 999 (99.9 feet). The listener is considered to be at [0,0] as shown below:

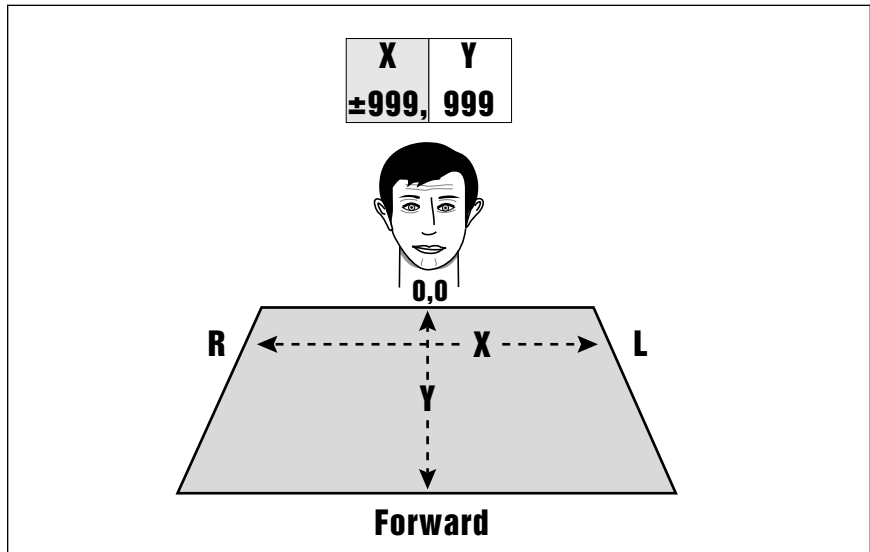

The first part of the coordinate designates the left/right position. The second part of the coordinate designates the forward positioning.

Time values range from 0 to the length of the current sample. Note that if this path is applied to a different sample, all time values will be scaled to the length of the different sample.

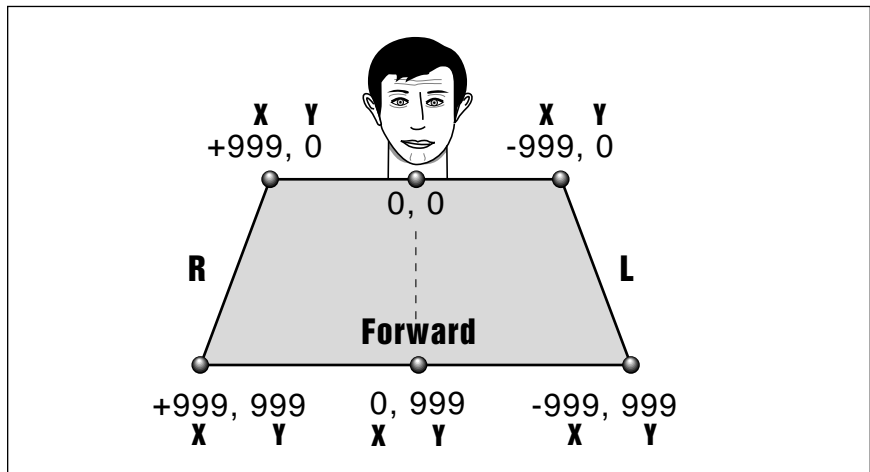

The diagram above shows the extreme positions of the path coordinates.

Once path editing is complete, press ENTER to return to the Path Management screen. When the path is ready to apply to the sample, press the left cursor button while in the Path Management screen to return to the main Doppler/Pan screen. Press ENTER again to move ahead to the Path Parameters screen and once more to process the sample.

8. Sonic Enhancer

The Sonic Enhancer adds brilliance and “cut” to a sample, making it stand out in a mix. This effect is especially effective on vocal samples to which it adds sheen, clarity and presence. The Sonic Enhancer works by generating new harmonics related to the source material.

The parameters are as follows:

- **Amount:** Sets the intensity of the effect. Lower values (<40%) tend to work best as they keep the effect subtle.
- **Tune:** Sets the frequency range of the effect, variable from 0-9. Higher numbers emphasize higher frequencies.
- **Fade In:** Sets the amount of time from the start point for the effect to fade in to the programmed amount.
- **Fade Out:** Sets the amount of time before the end point that it will take for the effect amount to fade out to zero.

► To Enhance a Sample:

1. Press the **Digital Processing** key.
2. Select **Digital Tools II (8), Sonic Enhancer (8)**.
3. If the current sample is stereo, the following screen appears. **Select the left side, right side, or both sides (stereo), then press Enter.** Otherwise proceed to the next step.

```
SONIC ENHANCER
Side: Stereo
Select L/R/Stereo
```

4. Select the section of the sample to be processed, then press **Enter**. The display shows the current endpoints, which are the endpoints of the sample.

```
ENHANCE secs samples
Start: 0.00 00000
End: 0.58 25745
Size: 0.58 25745
```

```
SONIC ENHANCER
Amount: 40%
Tune: 9
FadeIn:000 Out:000ms
```

5. Move the Cursor to the desired parameter, and adjust the value using the Data Entry Control. The Sonic Enhancement process will be applied to the sample between the selected start and end points.
6. If you are not satisfied with the resulting process, or want to compare before and after, proceed to Digital Processing, Undo (9).

9. Undo

Have you ever wanted a time machine so that you could go back and undo a mistake? This function may be the next best thing.

To Restore A Sample To Its Original State:

1. Activate Digital Processing module.
2. Select Submodule Undo (9).

```

UNDO  TRUNCATION
001  Selected Sample

Backup:      enabled
  
```

The display will show whether backup is currently enabled or not. If backup is not enabled, you will not be able to restore the sample. Otherwise, press ENTER. The original sample will be restored, the processed sample will be stored in the clipboard, and the ESI will return to the Module Identifier.

! Caution: *The Undo function will not work unless you have a hard disk drive connected.*

To Compare a Processed Sample with the Original Sample:

1. Activate Digital Processing module.
2. Select Undo (9).

```

REDO  TRUNCATION
001  Selected Sample

Backup:      enabled
  
```

The display will show whether backup is currently enabled or not. If backup is not enabled, you will not be able to compare samples. Otherwise, press ENTER. The original sample will be restored, the processed sample will be stored in the clipboard, and the ESI will return to the Module Identifier.

3. **Re-select Undo (9).** The processed sample will be restored, and the original sample will be stored in the clipboard. You can continue switching back and forth between the processed and original samples by repeating this step until you decide which sample you want to keep.

It is best to use Undo ONLY when you have a fixed hard disk drive installed on the SCSI bus. If you have only removable hard disks installed and remove the one containing the backup data, the ESI may become confused. The ESI will select a fixed hard disk as the backup drive, if available. If you have only removable disks and still want to use Undo, insert one removable disk in the drive. **Mount Drives in the Master menu sets the Undo device.** Leave the removable disk in the drive until you have finished all DSP operations.

To Disable or Enable the Backup Process:

1. Activate Digital Processing module.
2. Select Undo (9).

```
REDO TRUNCATION
S00 Selected Sample

Backup:      disabled
```

The display will show whether backup is currently enabled or not.

3. Use the INC/DEC buttons to choose whether the backup function is enabled or disabled, then press ENTER.

8

Preset Definition

0. Realtime Controls	161
1. Load Zone	166
2. Edit Assignment	169
3. Erase Zone	172
4. Copy Zone	173
5. Crossfade/Switch	176
6. Velocity Switch/Preset Link	183
7. Pitch Bend Range	184
8. Portamento & Attack	184
9. Effects	185

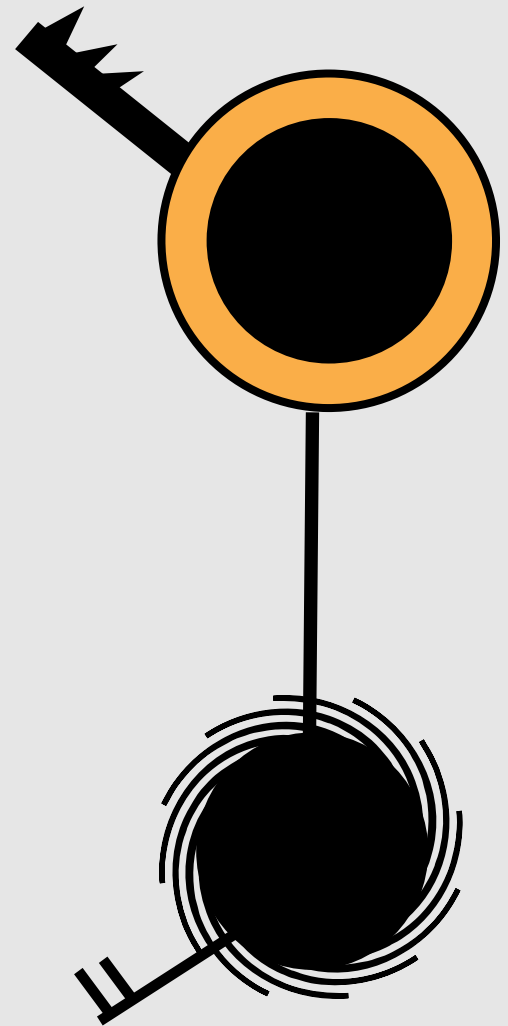

0. Realtime Controls

Realtime controls allow complex and expressive controls over the sound in real-time, hence their name. Realtime controls can be continuously varied over time and are designed for fast, easy selection while playing live. Each preset can have its own unique set of pre-programmed realtime functions.

The realtime control sources must be connected to a destination in order to have any effect. The second line of the display shows the realtime control source and the third line shows the destination (or what will be controlled by the source). Refer to the following diagram.

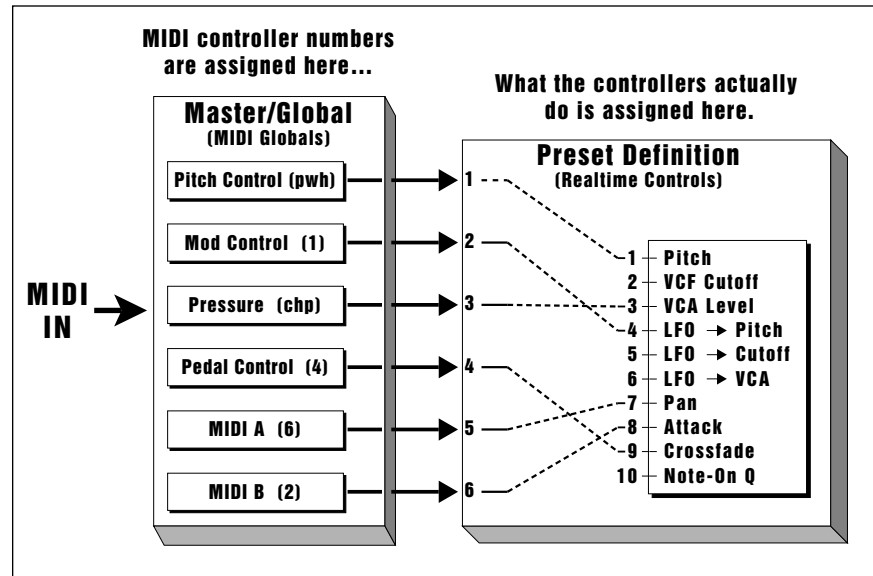

MIDI continuous controller numbers are matched to your keyboard in the MIDI submodule. The Realtime Controls submodule programs what these controllers actually do.

★ **Tip:** Realtime functions usually control the entire keyboard. However, when making up a preset, it is possible to exempt certain zones from realtime control. This is described in Dynamic Processing, 8. Realtime Control Enable.

For example, in order to have the pitch wheel of your keyboard control the pitch of the ESI, it must be assigned to pitch. Set the Pitch Control to be the source and the pitch as the destination. To make the right wheel control the amount of vibrato (LFO to pitch), set Mod Control as the source and LFO-> Pitch as the destination.

! **Remember:** The realtime control assignments are only one-half of the connection. The MIDI continuous controller numbers are assigned in the Master/Global, MIDI submodule.

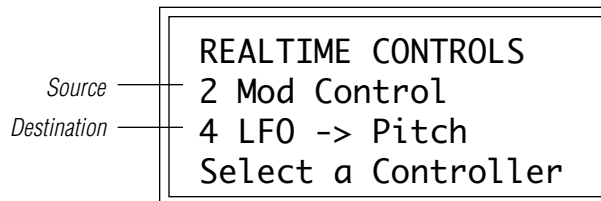

Despite their names: Pitch Control, Mod Control, Pressure Control and Pedal Control, any of the realtime controls can be assigned to any MIDI continuous controller number. The continuous controller number is assigned in the Master/Global, MIDI (9) submodule.

1. Activate Preset Definition module.
2. Select Realtime Controls (0).
3. Select a controller.

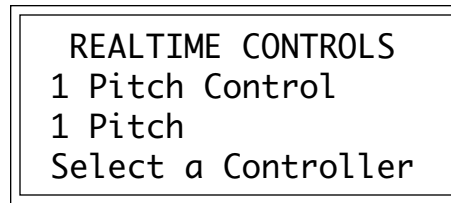

! Caution: Only one controller can be assigned to a destination. For example, if you assigned Mod. Control to VCF cutoff and then assigned Pressure Control to VCF cutoff, the ESI would automatically turn off the mod. control to VCF cutoff routing.

The eight assignable controllers are:

1. Pitch Control
2. Mod Control
3. Pressure Control
4. Pedal Control
5. MIDI A Control
6. MIDI B Control
7. Footswitch 1 Control
8. Footswitch 2 Control

4. Move the cursor to line three and select the destination for the previous selected controller. For some presets on factory disks, default destinations will already have been selected. For other presets, all control sources may be turned Off. **Each destination can be controlled by only one controller.**

★ **Tip:** Brass sounds often increase in brightness towards the end of the note. Simulate this effect by using the pedal or wheel to increase the filter cutoff frequency towards the end of the note.

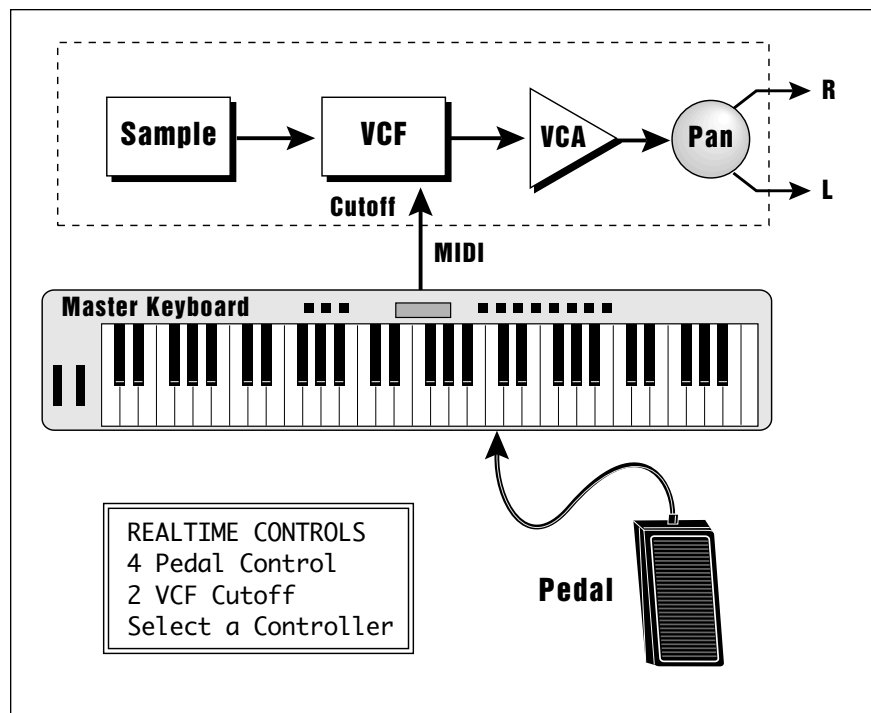

The diagram above shows the Realtime Control setting to control Cutoff Frequency with a Foot Pedal.

Select the control destination from the following options:

- 0. Off:** When chosen as a destination, this disables the control source.
- 1. Pitch:** Generally, this destination is assigned to the left-hand synthesizer wheel, which has a center detent. When so assigned, the center position gives no pitch bend. Rotating the wheel away from you bends pitch up, while rotating the wheel towards you bends pitch down. Maximum pitch bend is ± 12 semitones, as set in Preset Definition, Pitch Bend Range (7).
- 2. VCF Cutoff:** This destination is normally assigned to the Mod Control, Pressure Control, or Pedal Control to add expressiveness to your playing. VCF Cutoff interacts with the filter module frequency and envelope settings. If the wheel does not seem to be working correctly, check these settings. For example, if the filter cutoff is already at maximum, you will not be able to use the wheel to increase the cutoff frequency.
- 3. VCA Level:** Probably the most common use is to assign VCA level to the pedal, thus giving pedal-controlled volume. Or, assign this destination to the mod control when you need a manual volume control (such as during fadeouts). Assign VCA level to a MIDI controller for pseudo-automated mixdown effects when driving the ESI from a sequencer. The realtime control source adds to the initial amount as programmed in Dynamic Processing, VCA (2). For this destination to have any effect, the initial level of the zone must be set to a value less than 100%.
- 4. LFO -> Pitch:** This destination controls the extent to which the LFO modulates pitch, and is most often assigned to the mod control. Rotating the wheel away from you increases the amount of vibrato. Assigning this destination overrides the equivalent Dynamic Processing module function.
- 5. LFO -> Cutoff:** This destination controls the extent to which the LFO modulates the filter cutoff frequency. Assigning this destination overrides the equivalent Dynamic Processing module function.
- 6. LFO -> VCA:** This destination controls the extent to which the LFO modulates the overall level. This effect is called tremolo. Assigning this destination overrides the equivalent Dynamic Processing module function.
- 7. Pan:** This destination controls the spatial placement of the sound in the stereo field. When assigned to the pitch control, rotating the wheel away from you places the sound in one channel, rotating the wheel towards you places the sound in the other channel, and center wheel position places the sound in the center of the stereo field. You can also use the pedal for foot-controlled panning. Assigning this destination overrides the equivalent Dynamic Processing module function. The VCA pan position set in the Dynamic Processing module determines how the realtime controls will affect pan. Use the following chart to determine what effect a continuous controller will have on the pan position.

Controller	Effect on Pan Position
Pitch Control	Moves position Left or Right
Mod Control	Moves position Right
Pedal Control	Moves position Right
MIDI A Control	Moves position Right
MIDI B Control	Moves position Right
(+) Velocity	Moves position Right
(-) Velocity	Moves position Left

As an example, suppose you want the pedal to have full control of pan position. The Pedal Control can only move the sound to the right of its initial position. Therefore, you must set the initial pan position (Dynamic Processing, VCA (2)) to the extreme left. With the pedal fully up, the sound will appear at the extreme left. With the pedal centered, the sound will appear centered, and fully depressed, the sound will appear at the extreme right.

- 8. Attack:** This destination controls the VCA and VCF envelope attack rate. When assigned to the mod control, rotating the wheel away from you increases the attack time. This effect is useful when changing from legato to percussive effects, especially with sustained sounds such as strings.
- 9. Crossfade:** This destination fades the primary sample(s) out while fading the secondary sample(s) in, or vice-versa. When assigned to the pitch control, this function also provides for realtime mix changes between two separate sounds (e.g., strings can fade out while brass fades in). This function must also be enabled under Preset Definition, Crossfade/Switch (5).
- 10. VCF Note On Q:** This destination allows you to control Q with a continuous controller. Since this is a “Note-On” destination, the position of the controller is accessed only at the time the note is first turned on (key pressed).

The following is a description of the footswitch destinations:

0. **Off:** The footswitch is not on.
1. **Sustain:** If you play a looped sound while the footswitch is pressed, as soon as the looped portion begins, it will sustain (even after lifting your fingers off the keys) until the footswitch is released. Holding down the footswitch continuously provides a hold function for looped notes, where the last eight notes played will sustain for as long as the footswitch is pressed. If you play an unlooped sound while the footswitch is pressed, it will play through its entire length (whether or not you are holding down a key), then stop.
2. **Cross-Switch:** This provides footswitch-controlled switching between the primary and secondary samples. Pressing the footswitch will alternate between the two samples. This function must also be enabled under Preset Definition, 5. Crossfade/Switch.
3. **Unused 1**
4. **Unused 2**
5. **Unused 3**
6. **Unused A**
7. **Unused B**
8. **Preset Increment:** Press the footswitch to advance from one preset to the next higher numbered preset (i.e., from preset 01 to preset 02). The ESI will stop incrementing at the highest numbered preset.
9. **Preset Decrement:** Press the footswitch to fall back from one preset to the next lower numbered preset (i.e., from preset 02 to preset 01). The ESI will stop decrementing at the lowest numbered preset.

(Footswitch destinations 3-7 are EIII functions which were not implemented in the ESI. The numbers were retained to maintain compatibility.)

★ **Tip:** *Preset Increment/Decrement needs to be set for each preset if you want to step through all your presets.*

5. **Move the cursor to line two and repeat steps 3 and 4 to map additional controllers.**
6. **Press ENTER to exit the submodule.** The ESI will return to the Module Identifier.

1. Load Zone

This submodule allows a zone, including samples and dynamic processing parameters, to be loaded from the internal hard disk drive or external storage devices into any preset.

1. Activate Preset Definition module.
2. Select Submodule Load Zone (1).
3. If you wish to select a different drive, move the cursor to the drive number. If not, proceed to step 5.
4. Select the drive containing the zone to be loaded, then press ENTER.

```
LOAD ZONE from
D1 Main HD

Select a Drive
```

5. Select the bank that contains the preset from which the zone will be loaded, then press ENTER.

```
LOAD ZONE from
01 Main HD
B00 Current Bank

Select a Bank
```

❑ **Note:** Zone selection works slightly differently depending on the module you are using. In the Preset Definition module, Dynamic Processing parameters and Samples are selected when you select a zone. In the Dynamic Processing module, selecting a Zone only affects the Dynamic Processing parameters.

6. Select the preset that contains the zone to be loaded, then press ENTER.

```
LOAD ZONE from
P00 Current Preset

Select Source Preset
```

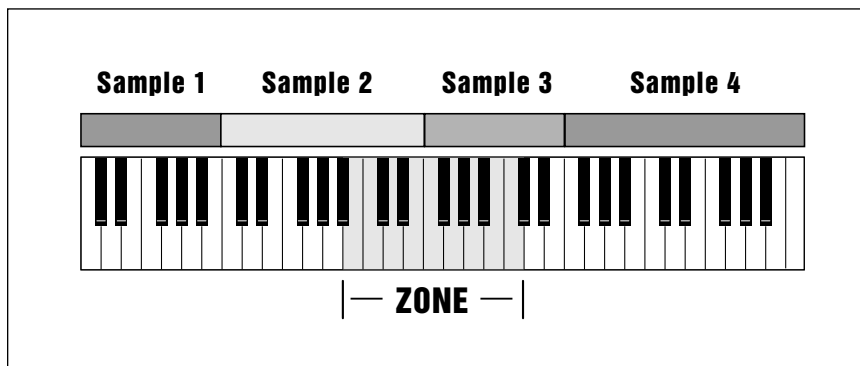

The zone contains samples as well as dynamic processing parameters.

! Caution: *If the source zone contains no secondary samples and you select both, loading the zone will overwrite both primary and secondary samples in the destination preset.*

7. Select whether you will load the primary, secondary, or both samples from the zone, then press ENTER.

```
LOAD ZONE from
P00 both

Select pri/sec/both
```

8. Select the lowest key of the zone to be loaded, then press ENTER. The default is the lowest note of the lowest sample. You can select a different low key in two ways. The Data Entry Control scrolls through the lowest key of each sample on the keyboard. The Data Entry Control is the fastest selection method if you want the lowest key of the zone to coincide with the lowest note of a sample. Or, you can use the keyboard to specify any note as the lowest note of the zone.

```
LOAD ZONE from
P00 both C1

Select Low Key
```

The second line shows the note being played on the keyboard (or scrolled with the Data Entry Control). After selecting a note, the third line displays the primary sample number, and the fourth line displays the secondary sample number associated with the note on line two.

9. Select the highest key of the zone to be loaded, then press ENTER. The default is the highest note of the sample that contains the previously specified low note. You can select a different high key in two ways. The Data Entry Control scrolls through the highest key of each sample on the keyboard. The Data Entry Control is the fastest selection method if you want the highest key of the zone to coincide with the highest note of a sample. Or, you can use the keyboard to specify any note as the highest note of the zone.

```
LOAD ZONE from
P00 both C1 to C2

Select High Key
```

The second line shows the note being played on the keyboard (or scrolled with the Data Entry Control). After selecting a note, the third line displays the primary sample number, and the fourth line displays the secondary sample number associated with the note on line two.

10. Select the preset into which the zone will be loaded, then press ENTER. The ESI defaults to the lowest numbered empty preset.

LOAD ZONE into
P01 Empty Preset

Select Dest Preset

If you select an empty preset, you will be given a chance to rename the preset that the ESI just created. Choose the characters you want to change with the left and right cursor buttons. Select the desired characters by using the ten key pad, Data Entry Control, and/or keyboard. You can also use the up cursor to insert spaces and the down cursor to delete spaces. After renaming is complete, press ENTER.

11. If you selected only primary or secondary samples, select whether you want to load them into the preset as primary or secondary samples. This step allows you to load primary sample(s) into secondary locations and visa versa. If in step 6 you selected both samples, the ESI will skip this step, as these samples will always be loaded into both primary and secondary sample slots of the destination preset.

! Caution: Loading a zone will overwrite any previously assigned notes that overlap with the zone being loaded.

LOAD ZONE into
P01 pri

Select pri/sec

12. Select the key where the low key of the zone will be placed, then press ENTER. As you select notes, the display will show the samples mapped into the preset. After loading, the ESI returns to the Module Identifier.

LOAD ZONE into
P01 both C1

Select New Low Key

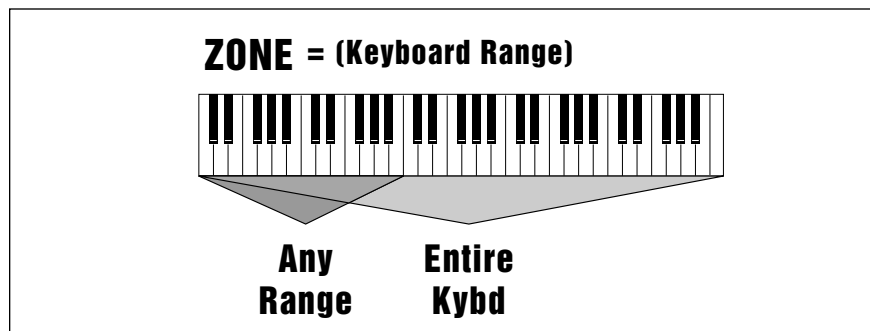

2. Edit Assignment

Use this function to change the zone assignment and original keys within a preset. Edit Assignment also tells you which samples are assigned to which keys.

1. Activate Preset Definition module.
2. Select the Edit Assignment Submodule (2).
3. If there are both primary and secondary samples, select which one you want to edit, then press ENTER. If there are only primary or secondary samples, the ESI will automatically go to step four.

★ **Tip:** To find out which samples are assigned to the keyboard, simply select Edit Assignment and play the keyboard. When you are finished, press Escape.

```
EDIT ASSIGNMENT
P00 pri

Select pri/sec/both
```

4. Select the lowest note of the zone to be re-assigned, then press ENTER. The default is to the lowest note of the lowest sample. You can select a different low key in two ways. The Data Entry Control scrolls through the lowest key of each sample on the keyboard. (The Data Entry Control is the fastest selection method if you want the lowest key of the zone to coincide with the lowest note of a sample.) Or, you can use the keyboard to specify any note as the zone's lowest note.

! **Caution:** Selecting zones in the Edit Assignment menu can be confusing. We recommend that the zone boundaries coincide with the boundaries of a single sample when editing assignments. (Use the Data Entry Control.)

```
EDIT ASSIGNMENT
P00 both C1

Select Low Key
```

The second line shows the note being played on the keyboard (or scrolled with the Data Entry Control). After selecting a note, the third line will display the primary sample number, and the fourth line will display the secondary sample number associated with the note on line two.

! **Caution:** Normally you will select the default high key (just press ENTER) unless you want to edit only part of a zone.

5. Use the Data Entry Control to select the highest note of the zone to be re-assigned, then press ENTER. The default is to the highest note of the sample that contains the previously specified low note. You can select a different high key in two ways. The Data Entry Control scrolls through the highest key of each sample on the keyboard. The Data Entry Control is the fastest selection method if you want the highest key of the zone to coincide with the highest note of a sample. Or, you can use the keyboard to specify any note as the highest note of the zone.

```
EDIT ASSIGNMENT
P00 both C1 to C2

Select High Key
```

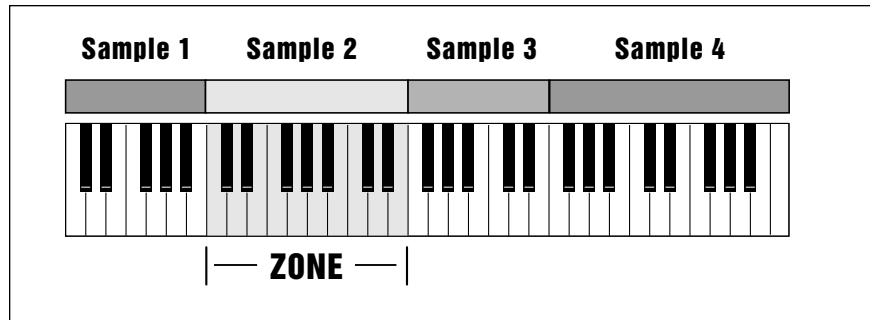

If you just want to select the existing zone, simply press ENTER when the display asks you for the high key. The entire zone will be selected.

The second line shows the note being played on the keyboard (or scrolled with the Data Entry Control). After selecting a note, the third line displays the primary sample number, and the fourth line displays the secondary sample number associated with the note on line two.

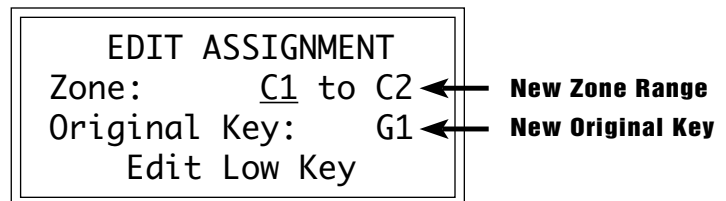

6. **Edit the assignment, then press ENTER.** The display shows the zone range (typically the low and high notes of a particular sample) and the original key. Use the cursor buttons to select parameter(s) to edit, and select keys by using the keyboard or Data Entry Control. **In this screen you set the new zone assignment.** If you extend the new zone so that it overlaps another sample on the same layer, it will replace the other sample in that area of the keyboard. After pressing ENTER the ESI will edit the zone range and the original key, and then return to the Module Identifier.

APPLICATION: Adjust the range of a sample.

1. **Activate Preset Definition module.**
2. **Select Edit Assignment (2).**
3. **Select the proper layer, then press ENTER.** If there are only primary or secondary samples, the ESI automatically goes to step four.
4. **Select the lowest note of the desired zone using the Data Entry Control, then press ENTER.** The Data Entry Control scrolls through the lowest note of each sample on the keyboard.
5. **When the display asks for the highest note of the zone, simply press ENTER.**
6. **Edit the zone's range.** Do not change the original key. (It need not be within the range of the zone.) If you are extending the range of a sample, the other samples will move to make room for the new zone.

APPLICATION: Transpose a Zone

1. Activate Preset Definition module.
2. Select Edit Assignment (2).
3. If there are both primary and secondary samples, select **Both**, then press **ENTER**. If there are only primary or secondary samples, the ESI will automatically go to step four.
4. Select the lowest note of the desired zone using the **Data Entry Control**, then press **ENTER**. The Data Entry Control scrolls through the lowest note of each sample on the keyboard.
5. Use the **Data Entry Control** to select the highest note of the zone, then press **ENTER**. The Data Entry Control scrolls through the highest note of each sample on the keyboard.
6. Edit the original key to transpose the zone. The original key need not be within the range of the zone. As an example, moving the original key down from G1 to G-0 would result in the zone being transposed up one octave. Moving the original key up from G1 to G2 would transpose the zone down one octave.

APPLICATION: Transpose Part of a Zone.

Suppose you wanted to transpose the area marked by the arrows down an octave to create a Snare of Doom sound. Here's how.

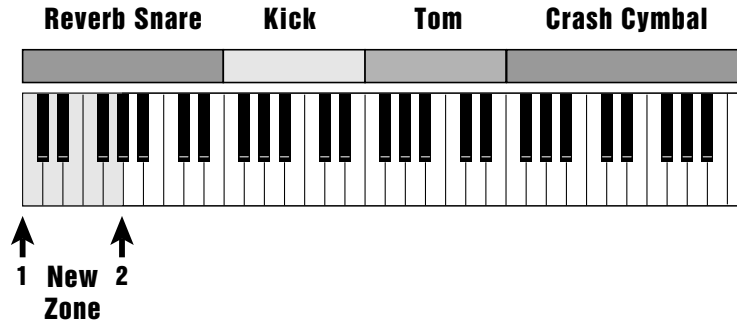

1. Activate Preset Definition module.
2. Select Edit Assignment (2).
3. If there are both primary and secondary samples, select **Both**, then press **ENTER**. If there are only primary or secondary samples, the ESI will automatically go to step four.
4. Select the note marked by arrow 1 using the keyboard, then press **ENTER**.
5. Select the note marked by arrow 2 using the keyboard, then press **ENTER**.
6. Edit the original key to transpose the zone. Move the cursor down to the third line of the display, then use the **INC/DEC** buttons to select a new original key. Moving the original key up transposes down and vice-versa. Press **ENTER**. Only the new zone will be transposed. Everything else remains as before.

3. Erase Zone

Use this function to erase a zone.

1. **Activate Preset Definition module.**
2. **Select Erase Zone (3).**
3. **If there are both primary and secondary samples, select the one you want to edit, then press ENTER.** If there are only primary or only secondary samples, the ESI automatically proceeds to step 4.

```
ERASE ZONE
P00 pri
Select pri/sec/both
```

4. **Select the lowest note of the zone to be erased, then press ENTER.** The default is to the lowest note of the lowest sample. You can select a different low key in two ways. The Data Entry Control scrolls through the lowest key of each sample on the keyboard. The Data Entry Control is the fastest selection method if you want the lowest key of the zone to coincide with the lowest note of a sample. Or, you can use the keyboard to specify any note as the lowest note of the zone.

```
ERASE ZONE
P00 both C1
Select Low Key
```

The second line shows the note being played on the keyboard (or scrolled with the Data Entry Control). After selecting a note, the third line displays the primary sample number, and the fourth line displays the secondary sample number associated with the note on line two.

5. **Use the Data Entry Control to select the highest note of the zone to be erased, then press ENTER.** The default is to the highest note of the sample that contains the previously specified low note. You can select a different high key in two ways. The Data Entry Control scrolls through the highest key of each sample on the keyboard. (The Data Entry Control is the fastest selection method if you want the highest key of the zone to coincide with the highest note of a sample.) Or, you can use the keyboard to specify any note as the highest note of the zone.

```
ERASE ZONE
P00 both C1 to C2
Select High Key
```

The second line shows the note being played on the keyboard (or scrolled with the Data Entry Control). After selecting a note, the third line displays the primary sample number, and the fourth line displays the secondary sample number associated with the note on line two.

6. Press Yes to erase the zone, or No to cancel the operation. In either case, you will return to the Module Identifier.

4. Copy Zone

This submodule allows zones to be copied into any preset.

1. Activate Preset Definition module.
2. Select Copy Zone (4).
3. Select the preset that contains the zone to be copied, then press ENTER.

COPY ZONE from
P00 Current Preset

Select Source Preset

4. Select whether you will copy the primary, secondary, or both samples from the zone, then press ENTER.

COPY ZONE from
P00 both

Select pri/sec/both

COPY ZONE from
P00 both C1

Select Low Key

! Caution: If the source zone contains no secondary samples and you select both, loading the zone will overwrite both primary and secondary samples in the destination preset.

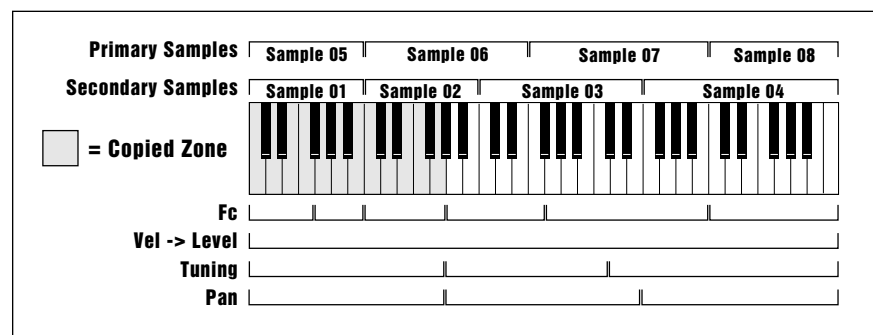

A copied zone consists of all Samples and Dynamic Processing parameters contained in that zone.

5. Select the lowest key of the zone to be copied, then press

ENTER. The default is the lowest note of the lowest sample. You can select a different low key in two ways. The Data Entry Control scrolls through the lowest key of each sample on the keyboard. (The Data Entry Control is the fastest selection method if you want the lowest key of the zone to coincide with the lowest note of a sample.) Or, you can use the keyboard to specify any note as the lowest note of the zone.

The second line shows the note being played on the keyboard (or scrolled with the Data Entry Control). After selecting a note, the third line displays the primary sample number, and the fourth line displays the secondary sample number associated with the note on line two.

6. Select the highest key of the zone to be copied, then press

ENTER. The default is the highest note of the sample that contains the previously specified low note. You can select a different high key in two ways. The Data Entry Control scrolls through the highest key of each sample on the keyboard. (The Data Entry Control is the fastest selection method if you want the highest key of the zone to coincide with the highest note of a sample.) Or, you can use the keyboard to specify any note as the highest note of the zone.

COPY ZONE from
P00 both C1 to C2

Select High Key

The second line shows the note being played on the keyboard (or scrolled with the Data Entry Control). After selecting a note, the third line displays the primary sample number, and the fourth line displays the secondary sample number associated with the note on line two.

7. Select the preset into which the zone will be copied, then press

ENTER. The ESI will default to the lowest numbered empty preset.

COPY ZONE into
P01 Empty Preset

Select Dest Preset

If you select an empty preset, upon pressing ENTER you will be given a chance to rename the preset that the ESI just created. Choose the characters you want to change with the left and right cursor buttons. Select the desired characters by using the ten key pad, Data Entry Control, and/or keyboard. You can also use the up cursor to insert spaces and the down cursor to delete spaces. After renaming is complete, press ENTER.

8. If you selected only primary or secondary samples, select whether you want to load them into the preset as primary or secondary samples. This step allows you to copy primary sample(s) into secondary locations and visa versa. If in step four you selected both samples, the ESI will skip this step, as these samples are always copied into both primary and secondary sample slots of the destination preset.

COPY ZONE from
P01 pri

Select pri/sec

! Caution: When a zone is copied, it overwrites that area of the destination preset.

9. Select the low key where the low key of the zone will be placed, then press ENTER. As you select notes, the display will show the samples mapped into the preset. After loading, the ESI will return to the Module Identifier.

LOAD ZONE into
P01 both C1

Select New Low Key

5. Crossfade Switch

This submodule offers several switching and crossfading functions. **Velocity Crossfade** crossfades between the primary and secondary samples according to how hard you play the keyboard. One sample will become louder as you play harder and softer as you play softer, while the other sample will become louder as you play softer and softer as you play harder. **Velocity Switch** is similar, but there is a threshold above which one sample plays and below which the other sample plays.

Where keyboard assignments of two samples overlap, **Positional Crossfade** alters the level (mix) between the two overlapping samples depending on where you play within the overlap range.

★ **Tip:** *Velocity crossfade is often used where the primary sample is a sound played softly and the secondary sample is a sample of the same sound played harder. Velocity crossfade causes the secondary sample to be brought in as you play the keyboard harder, producing a natural response.*

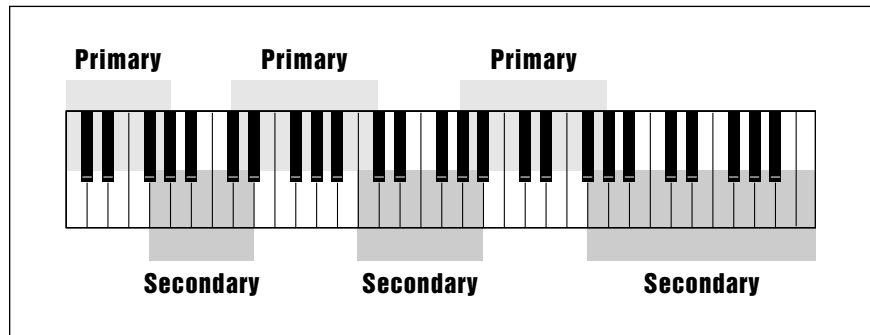

Positional Crossfade can be used to create seamless sample boundaries. The overlapping portions of the primary and secondary samples will be crossfaded.

1. Activate Preset Definition module.
2. Select the Crossfade/Switch submodule (5).
3. Select the lowest key of the zone to be crossfaded or switched, then press ENTER. The default is to the lowest note of the lowest sample. You can select a different low key in two ways. The Data Entry Control scrolls through the lowest key of each sample on the keyboard. The Data Entry Control is the fastest selection method if you want the lowest key of the zone to coincide with the lowest note of a sample. Or, you can use the keyboard to specify any note as the lowest note of the zone.

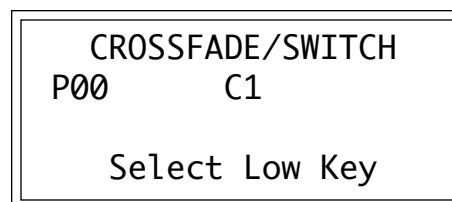

The second line shows the note being played on the keyboard (or scrolled with the Data Entry Control). After selecting a note, the first line displays the zone's crossfade status, the third line displays the primary sample number, and the fourth line displays the secondary sample number associated with the note on line two.

4. **Select the highest key of the zone to be crossfaded or switched, then press ENTER.** The ESI defaults to the highest note of the sample that contains the previously specified low note. You can select a different high key in two ways. The Data Entry Control scrolls through the highest key of each sample on the keyboard. The Data Entry Control is the fastest selection method if you want the highest key of the zone to coincide with the highest note of a sample. Or, you can use the keyboard to specify any note as the highest note of the zone.

```
CROSSFADE/SWITCH
P00      C1 to C2

Select High Key
```

The second line shows the note being played on the keyboard (or scrolled with the Data Entry Control). After selecting a note, the first line displays the zone's crossfade status, the third line displays the primary sample number, and the fourth line displays the secondary sample number associated with the note on line two.

5. **Select the desired type of crossfade from the following choices, then press ENTER.**

```
CROSSFADE/SWITCH
P00      C1 to C2
Crossfade Off
Select a Crossfade
```

- **Crossfade Off:** There is no crossfading between the primary and secondary samples.
- **Velocity Crossfade:** One sample will become louder as you play more forcefully; the other sample will become softer.
- **Velocity Switch:** If you strike a key with more force than the mid-point of the velocity range, one sample will play. If you strike a key with less force than the mid-point of the velocity range, the other sample will play.
- **Positional Crossfade:** As you play from low to high over the selected zone, one sample will fade out as the other sample fades in. This is a useful technique for maintaining an even tone quality over the keyboard when multi-sampling.
- **Realtime Crossfade:** Crossfading occurs not according to keyboard velocity, but according to the realtime controller that has been assigned in Preset Definition, Realtime Controls (0).

- **Realtime Switch:** Switching occurs not according to keyboard velocity, but according to the realtime footswitch values set in Preset Definition, Realtime Controls (0).
- **Velocity Ranges:** Allows you to control the velocity settings for crossfading or crossswitching between the primary and secondary layers or between linked presets.

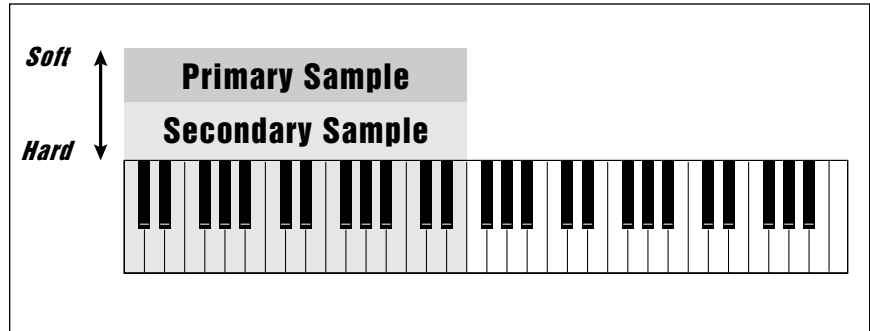

Velocity Crossfade. If the secondary sample equals "Hard", the primary sample becomes progressively softer and the secondary sample becomes louder with increasing playing force.

6. Select whether the primary or secondary sample will play when the keyboard is played forcefully, then press ENTER. If you choose Positional Crossfade, skip this step and go to Step 7.

CROSSFADE/SWITCH
P00 pri C#1 to C2
Velocity Crossfade
pri or sec Hard

Use the Data Entry Control to select whether the primary or secondary sample will:

- Fade in when the keyboard is played forcefully (Velocity Crossfade)
- Switch in when the keyboard is played forcefully (Velocity Switch)
- Fade in according to the realtime control wheel (Realtime Crossfade)
- Switch in according to the realtime footswitch (Realtime Switch)

After pressing ENTER the ESI will return to the Module Identifier.

7. For Positional Crossfade, select whether the primary or secondary sample will increase in level as you play higher on the keyboard, then press ENTER. The other sample will decrease in level.

CROSSFADE/SWITCH
P00 C1 to C2
Positional Crossfade
pri or sec = at Top

8. For Velocity Ranges, select Velocity Range as the Crossfade-Switch parameter and press ENTER. Next, select the velocity ranges in the Preset Definition module, Vel Switch Pt/Link (6).

• **Crossswitch between the Primary and Secondary Layers**

In this example, the Primary layer plays when the key velocity is below 96 and the Secondary layer plays when the key velocity is 96 or greater.

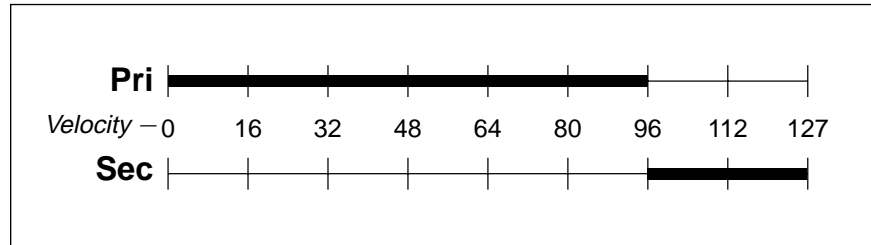

1. Press the Preset Definition key.
2. Select Crossfade Switch (5).
3. Select the lowest key of the zone to be crossfaded or switched, then press ENTER. The default is to the lowest note of the lowest sample. You can select a different low key in two ways. The Data Entry Control scrolls through the lowest key of each sample on the keyboard. The Data Entry Control is the fastest selection method if you want the lowest key of the zone to coincide with the lowest note of a sample. Or, you can use the keyboard to specify any note as the lowest note of the zone.

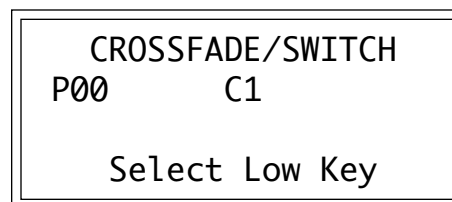

The second line shows the note being played on the keyboard (or scrolled with the Data Entry Control). After selecting a note, the first line displays the zone's crossfade status, the third line displays the primary sample number, and the fourth line displays the secondary sample number associated with the note on line two.

4. Select the highest key of the zone to be crossfaded or switched, then press ENTER. The ESI defaults to the highest note of the sample that contains the previously specified low note. You can select a different high key in two ways. The Data Entry Control scrolls through the highest key of each sample on the keyboard. The Data Entry Control is the fastest selection method if you want the highest key of the zone to coincide with the highest note of a sample. Or, you can use the keyboard to specify any note as the highest note of the zone.

```

CROSSFADE/SWITCH
P00      C1 to C2

Select High Key

```

The second line shows the note being played on the keyboard (or scrolled with the Data Entry Control). After selecting a note, the first line displays the zone's crossfade status, the third line displays the primary sample number, and the fourth line displays the secondary sample number associated with the note on line two.

5. Select Velocity Ranges crossfade from the seven choices, then press ENTER.

```

CROSSFADE/SWITCH
P00      C1 to C2
Velocity Ranges
Select a Crossfade

```

6. Select the Velocity Switch/ Preset Link Submodule (6).
7. Press the Right Cursor key. The following screen appears.

```

VEL SWITCH PT/LINK
Velocity Ranges:
Pri:          0 to 95
Sec:          96 to 127

```

8. Set the Primary and Secondary Velocity Ranges and press ENTER. After pressing ENTER, the ESI returns to the Module Identifier.

• Crossswitch between Four Layers in Two Presets

The following example shows how to make a four way velocity crossswitch using a linked preset. The Primary layer of Preset #1 plays when velocity is in the range of 1-32. The Secondary layer of Preset #1 plays when velocity is in the range of 33-64. The Primary layer of the Linked Preset plays when velocity is in the range of 65-96. The Secondary layer of the Linked Preset plays when velocity is from 97 to 127.

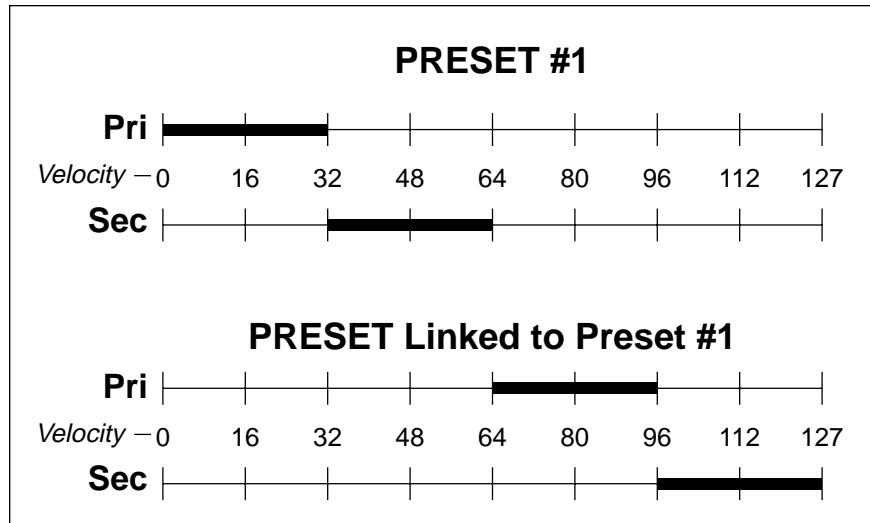

1. Press the Preset Definition key.
2. Select Submodule Crossfade/Switch (5).
3. Define the zone as described in the previous example.
4. Select Velocity Ranges crossfade from the seven choices, then press ENTER.

```

CROSSFADE/SWITCH
P00      C1 to C2
Velocity Ranges
Select a Crossfade
  
```

5. Select submodule Vel Switch Pt/Link (6). The following screen appears. Move the Cursor down to the lower line using the down cursor key.

```

VEL SWITCH PT/LINK
Vel Switch Point: 60
Link Preset to
001 Percussion 2
  
```

6. Select the Preset to be Linked. Linking Presets allows multiple presets to play at once.
7. Press the Right Cursor key. The following screen appears.

```

VEL SWITCH PT/LINK
Velocity Ranges:
Pri:      0 to 32
Sec:     33 to 64

```

8. Set the Primary and Secondary Velocity Ranges and press ENTER. After pressing ENTER, the ESI returns to the Module Identifier.
9. Press Preset Definition to deactivate the module and return to the Preset Selection screen.
10. Select the Linked Preset.
11. Press the Preset Definition key.
12. Select submodule Vel Switch Pt/Link (6).
13. Press the Right Cursor key. The following screen appears.

```

VEL SWITCH PT/LINK
Velocity Ranges:
Pri:      65 to 96
Sec:     97 to 127

```

14. Set the Velocity Ranges as shown above so that all four layers now have their own velocity range and press ENTER. After pressing ENTER, the ESI returns to the Module Identifier.
15. Return to the first preset.
16. Play the Keyboard soft at first, then harder and harder. You should hear the four different layers play as you vary the velocity.

Other Ideas

- By overlapping the velocity ranges you can create other special effects like having the Secondary layer come in only when a specific velocity is reached.

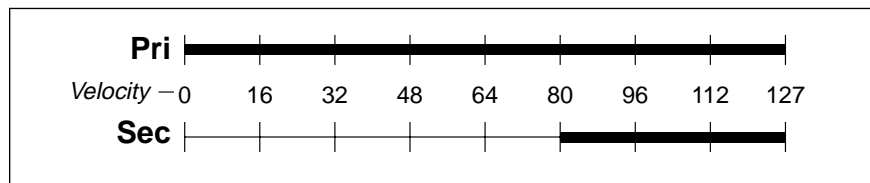

- With an effect assigned to a single layer you can use velocity to switch in effects such as echoes, chorus or reverb.
- Because you can link as many presets as you want, you could assign each layer to a very small velocity range so that different presets will be selected in a seemingly random way.

6. Velocity Switch/ Preset Link

This submodule contains two completely unrelated functions.

- The velocity cross-switch function in the Preset Definition, Crossfade/ Switch submodule (5) allows overlapping samples to be switched according to key velocity. The Velocity Switch portion of this module sets the velocity at which samples are cross-switched.
- The current preset can be linked with another preset, allowing you to place multiple presets on each key of the keyboard. As an example, suppose you link preset 001 to preset 002 and that preset 002 has previously been linked to preset 008. When preset 001 is played, presets 002 and 008 will play as well. When preset 002 is played, preset 008 will also play. The polyphony of the ESI will vary according to the voice architecture of each preset in the stack. If two presets are linked to themselves, forming a loop, those two presets will play in unison up to the channel limit of the ESI.

1. **Activate Preset Definition module.**
2. **Select Vel Switch Pt/Link (6).**
3. **Use the Data Entry Control to select the velocity at which samples will be cross-switched.** Values range from 1 to 127.

```
VEL SWITCH/PT LINK
Vel Switch Point: 64
Link Preset to:
Pxx Off
```

4. **Move the cursor down one line and use the Data Entry Control to choose the preset (or none) that will be linked to the current preset.**
5. **Press the Right Cursor key.** The following screen appears.

```
VEL SWITCH PT/LINK
Velocity Ranges:
Pri:      65 to 96
Sec:      97 to 127
```

6. **Set the Velocity Ranges and press ENTER.**

After pressing ENTER, the ESI returns to the Module Identifier.

7. Pitch Bend Range

This submodule adjusts the pitch wheel range from ± 0 to ± 12 semitones.

1. Activate Preset Definition module.
2. Select Pitch Bend Range (7).
3. Select the desired pitch bend range.

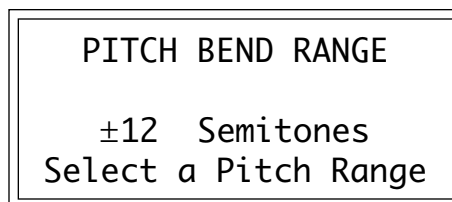

4. Press ENTER to exit the submodule. The ESI returns to the Module Identifier.

This submodule contains two completely unrelated functions:

8. Portamento & Attack

- **Portamento** is a smooth gliding of pitch from note to note rather than the normal instantaneous change in pitch. Portamento affects all zones in the preset, but can be adjusted separately for the primary and secondary layers. Values are entered in number of seconds per octave from the last key to the current key. Portamento glides at a linear rate with a range programmable from 0.0 seconds (Off) to 32 seconds/octave.
- **Attack Trajectory** defines the attack curve of the ESI envelope generators. There are two selectable slopes: Linear or Logarithmic which affect all zones in the layer. A logarithmic attack rises quickly, then levels off as it approaches maximum level. Logarithmic mode works well for sounds with percussive attacks, while Linear mode tends to work better on sounds with slow attacks.

1. Activate Preset Definition module.
2. Select Submodule Portamento/Attack (9).
3. Select the desired portamento rate for the primary and secondary layers.

```
PORTAMENTO  ✦
Pri:      0.5 sec/oct
Sec:      1.5 sec/oct
```

4. Select page two by pressing the right cursor button.

```
✦ ATTACK TRAJECTORY
Pri:      logarithmic
Sec:      linear
```

5. Press ENTER to exit the submodule. The ESI will return to the Module Identifier.

9. Effects

Effects Programmed in the Preset

This function is available only when the Turbo Option Kit is installed in the ESI. For detailed instructions on how to use the Effects submodule, refer to the Appendix.

When playing single presets (Omni or Poly mode) the effects are normally programmed as part of the preset. Because there are only two effects processors for the entire machine, each preset cannot have its own effect in Multimode where up to 16 presets can be played at once.

9

Dynamic Processing

Background	189
0. Select Zone.....	196
1. Setup	197
2. VCA	198
3. VCF	200
4. LFO	202
5. Auxiliary Envelope	204
6. Velocity To	205
7. Keyboard Mode	207
8. Realtime Control Enable..	208
9. Channel Assignment	209

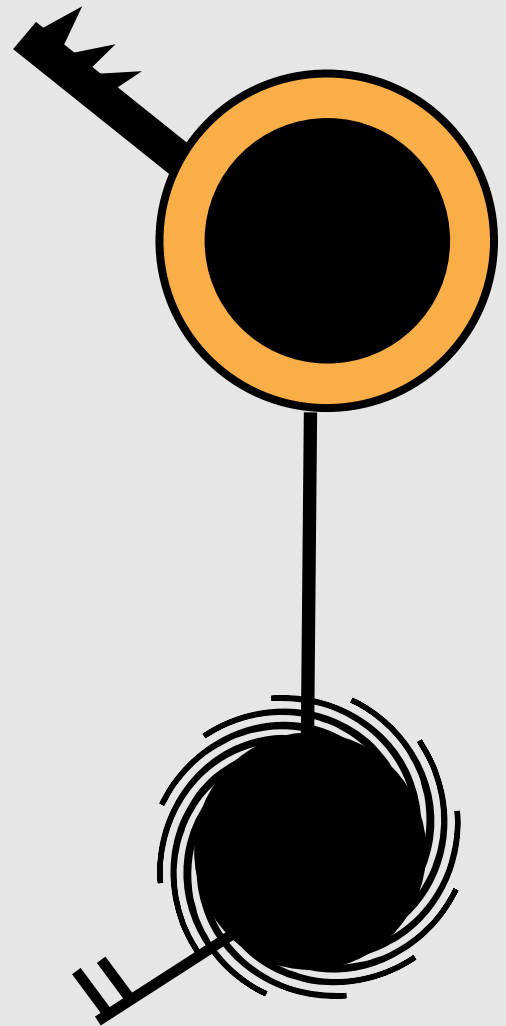

Background

The Dynamic Processing module of the ESI provides you with all the intuitive control options of an analog synthesizer. But, since you are starting with complex digitally sampled sounds instead of simple square or sawtooth waveforms, the possibilities are multiplied dramatically. Each of the 64 channels contains three AHDSR type envelope generators, one multi-waveform LFO with delay and variation, 19 ultra powerful filters (VCF) with resonance, one level VCA, one stereo panning network, and an extremely flexible routing scheme which ties everything together. The diagram below illustrates the layout of an ESI channel.

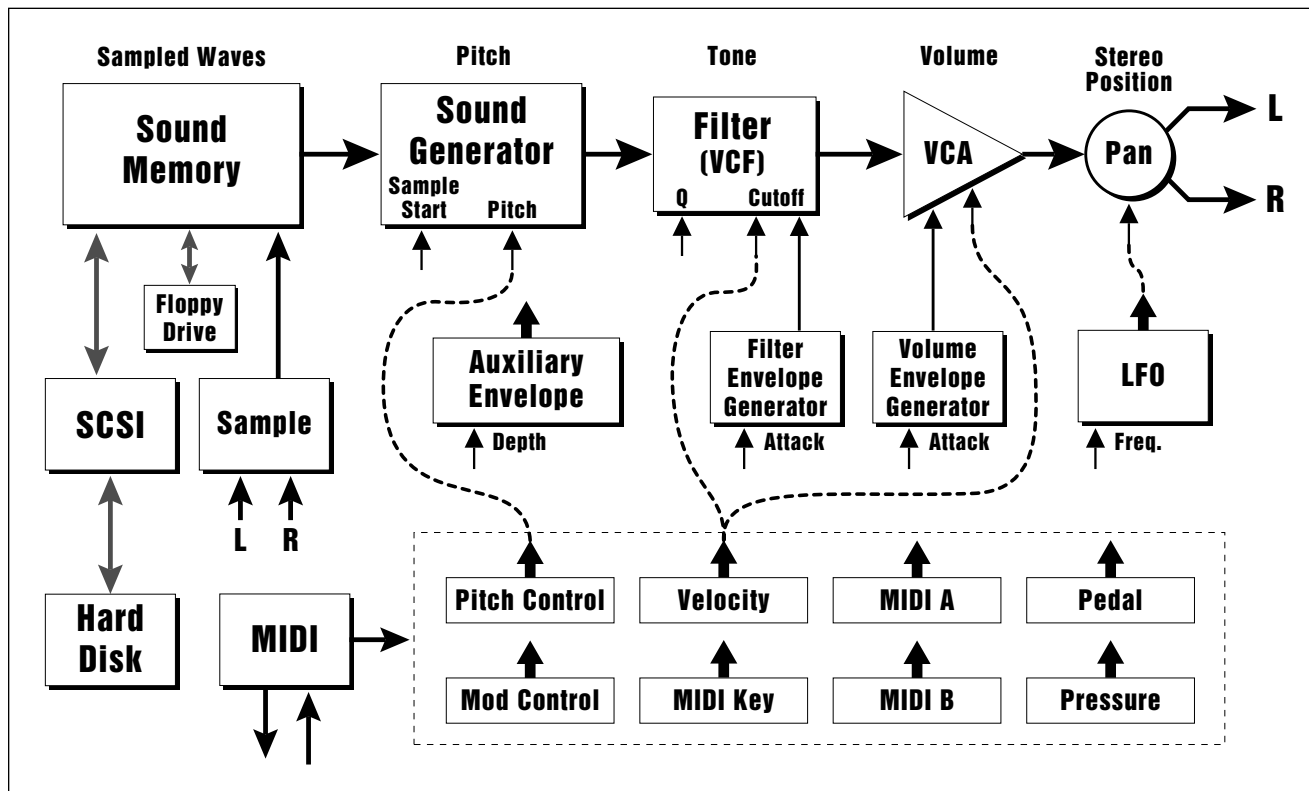

This block diagram illustrates the general architecture of the ESI. The dotted lines show how realtime controllers, envelopes and LFOs can be routed to modulate the sound.

Each key on the keyboard can contain two zones (primary and secondary, just like samples), and each of these can have completely different sets of analog parameters applied to it. The zone concept makes the programming and modifying of parameters quite straightforward.

■ **Note:** Zone selection works slightly differently depending on the module you are using. In the Dynamic Processing module, selecting a Zone only affects the Dynamic Processing parameters. In the Preset Definition module however, Dynamic Processing parameters and Samples are selected when you select a zone.

The Zone Concept

A zone is simply a selected range of the keyboard. That's it! Nothing mysterious about it. Dynamic processing parameters can be programmed for any range of the keyboard (zone) regardless of where the samples lie. For instance, a completely different pan, LFO rate, and VCA envelope can be set for each individual key, or range of keys.

Zones can be set differently for each parameter you are adjusting. For example, the VCF cutoff can be set to one value for the entire keyboard, the pan position can be set for each individual key, and then the VCA envelope can be set for a portion, or all of the keyboard. Simply define the zone for the desired keyboard range and change the parameter. That's all there is to it.

! Caution: *Be careful! Quick Zone can be a bit confusing at times. Quick Zone was designed as a convenience feature for advanced programmers. It's probably best to leave quick zone turned Off until you have a good feel for programming presets.*

Quick Zone

Quick Zone offers an especially fast and efficient means of creating and accessing zones in the Dynamic Processing module. When Quick Zone is "On", all you need to do in order to create or access a zone is press down the keys on the keyboard defining the range and access the Dynamic Processing parameters. For example, if two keys such as C2 and A#3 are held down and the filter cutoff is changed, then all samples in the range C2-A#3 will be assigned the new filter cutoff value.

To access Quick Zone, enter the Dynamic Processing module. The display will show:

```
DYNAMIC PROCESSING
P00 both C#1 to C#5
Quick Zone:      off
Select a Submodule
```

Use the left and right cursor buttons to select: Off, Pri, Sec or Both. Quick Zone remains on until you turn it off or until the ESI is rebooted.

Filter Background

The ESI has 19 different filter types. These ultra powerful filters were originally developed for the Morpheus Z-plane synthesizer. In addition to Lowpass, Highpass and Bandpass filters, we have included Swept EQ filters, Phasers, Flangers and Vocal filters as well as a special bass distortion filter we call the "Bottom Feeder." Before the actual filter descriptions, we have included a short section explaining how the different types of filters work.

To understand how a filter works we need to understand what makes up a sound wave. A sine wave is the simplest form of sound wave. Any waveform except a sine wave can be analyzed as a mix of sine waves at specific frequencies and amplitudes.

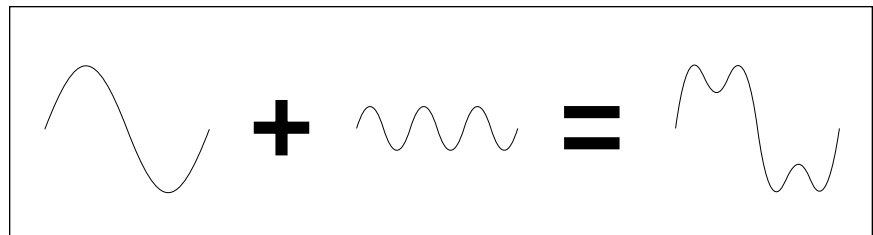

One way to represent complex waveforms is to use a chart with frequency on one axis and amplitude on the other. Each vertical line of the chart represents one sine wave at a specific amplitude.

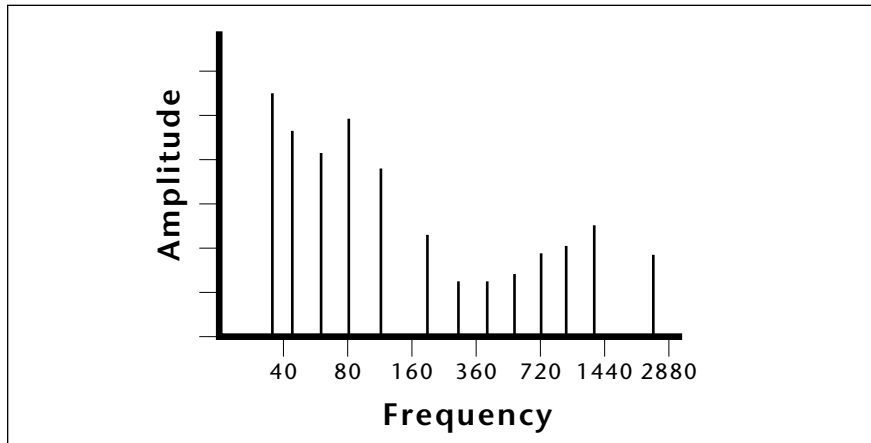

Each vertical line of the chart represents one sine wave at a specific amplitude.

Most sounds are complex waves containing many sine waves of various amplitudes and frequencies. A **filter is a device which allows us to remove certain components of a sound depending on its frequency.** For example, a Low Pass Filter, lets only the *low frequencies pass* and removes only the high frequencies.

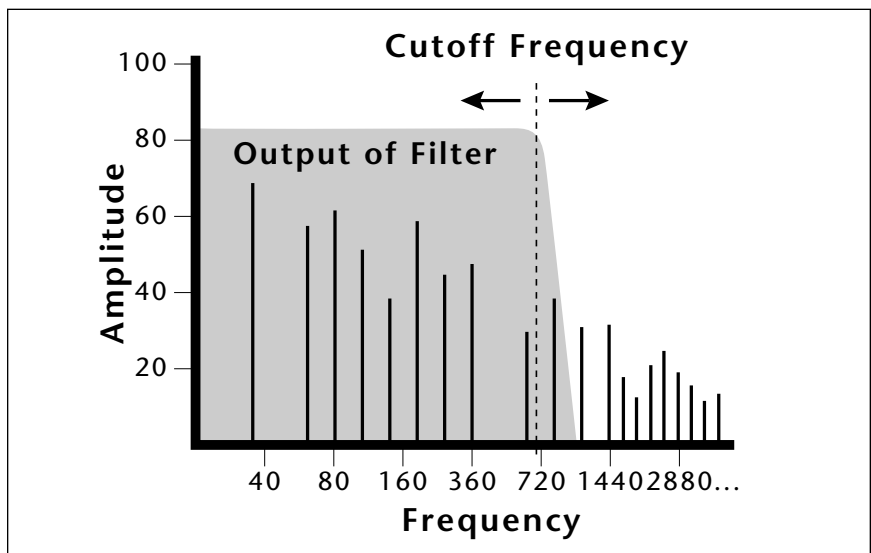

The point at which the frequencies are rejected is called the **Cutoff Frequency** (or F_c for short). A filter that lets the frequencies above the F_c pass is called a High Pass filter. Using a filter, we now have a way to control the harmonic content of a sampled sound. As it turns out, a low pass filter can simulate the response of many natural sounds.

For example, when a piano string is struck by its hammer, there are initially a lot of high frequencies present. If the same note is played softer, there will be fewer of the high frequencies generated by the string. We can simulate this effect by routing the velocity of the keyboard to control the amount of high frequencies that the low pass filter lets through. The result is expressive, natural control over the sound.

The auxiliary envelope generator is commonly used to control the cutoff frequency of the Z-plane filter. This allows the frequency content to be varied dynamically over the course of the note. Dynamic filtering, coupled with all the different instruments available, makes for endless possibilities in the final sound.

Another control on the filter is called Q, or resonance. On a lowpass or highpass filter, turning up the Q of the filter emphasizes the frequencies around the cutoff frequency. The chart below shows how different levels of Q affect the lowpass filter response.

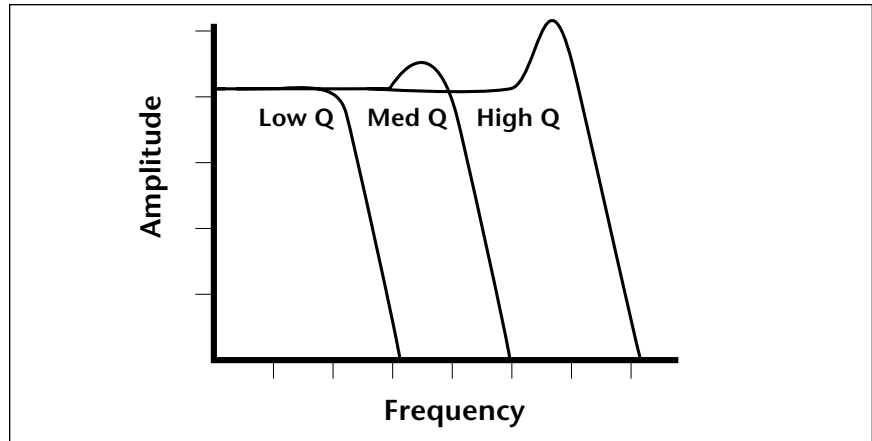

Turning up the “Q” emphasizes the frequencies around the cutoff point.

In terms of sound, frequencies around the cutoff tend to “ring” with high Q settings. If the filter is swept back and forth slowly with a high Q, various overtones will be “picked out” of the sound and amplified as the resonant peak sweeps over them. Bells and gongs are real world examples of sounds which have a high Q.

Another important feature of a filter is the number of poles it contains. The lowpass filters can be either 2-pole, 4-pole or 6-pole filters. The highpass and bandpass filters can be either 2nd or 4th order filters, which is another way to describe the number of filter sections they contain. The number of poles in a filter describes the steepness of its slope. The more poles the steeper the slope, which in turn affects the sound. In general, the 2-pole filter will have a buzzy sound and the 4-pole filter has the classic low pass resonant filter sound. ESI's 6-pole low pass filters create a tight, modern sound.

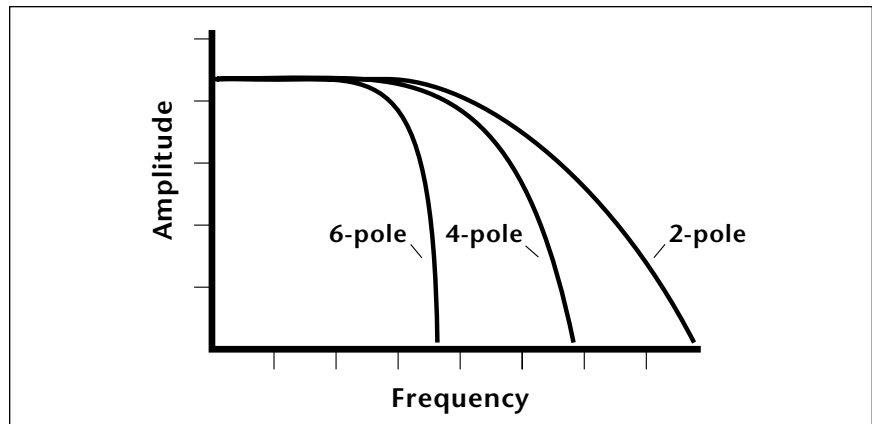

Parametric Filters

A more complex type of filter is called a parametric filter or Swept EQ. A parametric filter allows control over three basic parameters of the filter. The three parameters are: *Frequency*, *Bandwidth*, and *Boost/Cut*. The Frequency parameter (Labelled cutoff on the ESI filters) allows you to select a range of frequencies to be boosted or cut. The Bandwidth parameter allows you to select the width of the range. (Bandwidth and Frequency are combined into the Cutoff parameter in ESI's EQ filters.) The Boost/Cut parameter (Q on the ESI filters) either boosts or cuts the frequencies within the selected band by a specified amount. Frequencies not included in the selected band are left unaltered. This is different from a band pass filter which attenuates (reduces) frequencies outside the selected band.

The parametric filter is quite flexible. Any range of frequencies can be either amplified or attenuated. Often times, several parametric sections are cascaded (placed one after another) in order to create complex filter response curves.

The Z-Plane Filter

The Z-plane filter can change its function over time. In a simple Z-plane filter, we start with two complex filter types and interpolate between them using a single parameter. Refer to the diagram below.

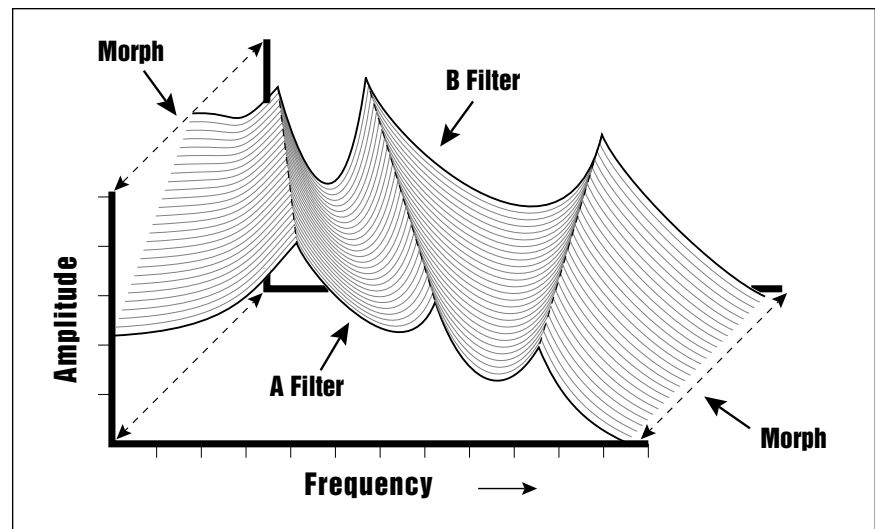

The Z-plane filter has the unique ability to change its function over time.

Filters A and B represent two different complex filters. By changing a single parameter, the Morph, many complex filter parameters can now be changed simultaneously. Following along the Morph axis you can see that the filter response smoothly interpolates between the two filters.

This is the essence of the Z-plane filter. Using interpolation, many complex parameters are condensed down into one manageable entity.

Consider, as an example, the human vocal tract, which is a type of complex filter or resonator. There are dozens of different muscles controlling the shape of the vocal tract. When speaking, however, we don't think of the muscles, we just remember how it feels to form the vowels. A vowel is really a configuration of many muscles, but we consider it a single object. In changing from one vowel to another, you don't need to consider the frequencies of the resonant peaks! You remember the shape of your mouth for each sound and interpolate between them.

Filter morphing can be controlled by an envelope generator, an LFO, modulation wheels or pedals, keyboard velocity, key pressure, etc. The filter Cutoff parameter controls morphing on certain filters. The Q parameter can control various parameters such as boost/cut and mouth cavity size and of course, resonance or Q.

ESI Filter Types

2-pole Lowpass

Lowpass filter with 12dB/octave rolloff and Q control.

4-pole Lowpass

Lowpass filter with 24dB/octave rolloff and Q control.

6-pole Lowpass

Lowpass filter with 36dB/octave rolloff and Q control.

2nd Order Highpass

Highpass filter with 12dB/octave rolloff and Q control.

4th Order Highpass

Highpass filter with 24dB/octave rolloff and Q control.

2nd Order Bandpass

Bandpass filter with 6dB/octave rolloff on either side of the passband and Q control.

4th Order Bandpass

Bandpass filter with 12dB/octave rolloff on either side of the passband and Q control.

Contrary Bandpass

A novel bandpass filter where the frequency peaks and dips cross midway in the frequency range.

Swept EQ, 1-octave

Parametric filter with 24 dB of boost or cut and a one octave bandwidth. Cutoff controls center frequency and Q controls boost or cut.

Swept EQ, 2->1-octave

Parametric filter with 24 dB of boost or cut. The bandwidth of the filter is two octaves wide at the low end of the audio spectrum, gradually changing to one octave wide at the upper end of the spectrum. The filter Cutoff controls the center frequency and the Q parameter controls the boost or cut.

Swept EQ, 3->1-octave

Parametric filter with 24 dB of boost or cut. The bandwidth of the filter is three octaves wide at the low end of the audio spectrum, gradually changing to one octave wide at the upper end of the spectrum. The filter Cutoff controls the center frequency and the Q parameter controls the boost or cut.

Phaser 1

Creates a comb filter effect typical of phase shifters. Filter Cutoff moves the position of the notches. Q varies the depth of the notches.

Phaser 2

Comb filter with slightly different notch spacing than Phaser 1. Filter Cutoff moves the position of the notches. Q varies the depth of the notches.

Bat-Phaser

Phase shifter with peaks as well as notches. Filter Cutoff moves the position of the peaks and notches. Q varies the depth of the peaks and notches.

Flanger Lite

Contains three notches. Filter Cutoff moves frequency and spacing of the notches. Q increases flanging depth.

Vocal Ah-Ay-Ee

Vowel formant filter which sweeps from the “Ah” sound, through “Ay” sound to “Ee” sound at maximum Cutoff. Q varies the apparent size of the mouth cavity.

Vocal Oo-Ah

Vowel formant filter which sweeps from the “Oo” sound, through “Oh” sound to “Ah” sound at maximum cutoff. Q varies the apparent size of the mouth cavity.

Bottom Feeder

This is a specialized distortion filter, useful for adding punch and drive to low frequency sounds such as bass and drums. Set the Cutoff frequency low (less than 100) for best effect. Q has no effect on this filter.

ESI/E3X Lowpass

This is the original ESI-32 lowpass filter. It has been included to maintain backward compatibility. Banks created on the ESI-32 will use this filter by default.

0. Select Zone

This submodule lets you specify the keyboard zone to be processed.

1. Activate Dynamic Processing module.
2. Select Submodule Select Zone (0).
3. If there are both primary and secondary samples assigned to the preset, select whether the zone will contain both samples, just the primary, or just the secondary. Press ENTER. If the preset contains only primary or secondary samples, the ESI will bypass this screen and proceed immediately to step 4.

```
SELECT ZONE
P00 both

Select pri/sec/both
```

! Caution: *If a zone contains more than one sample, the new original key will be assigned to all samples in the selected zone.*

4. Select the lowest key of the zone and press ENTER. The default is the lowest note of the lowest sample. You can select a different low key in two ways. The Data Entry Control scrolls through the lowest key of each sample on the keyboard. (The Data Entry Control is the fastest selection method if you want the lowest key of the zone to coincide with the lowest note of a sample.) Or, you can use the keyboard to specify any note as the lowest note of the zone.

```
SELECT ZONE
P00 both C#1

Select Low Key
```

The second line shows the note being played on the keyboard (or scrolled with the Data Entry Control). After selecting a note, the third line will display the primary sample number, and the fourth line will display the secondary sample number associated with the note on line two.

5. Select the highest key of the zone and press ENTER. The default is the highest note of the sample that contains the previously specified low note. You can select a different high key in two ways. The Data Entry Control scrolls through the highest key of each sample on the keyboard. (The Data Entry Control is the fastest selection method if you want the highest key of the zone to coincide with the highest note of a sample.) Or, you can use the keyboard to specify any note as the highest note of the zone.

```
SELECT ZONE
P00 both C#1 to C#5

Select High Key
```

The second line shows the note being played on the keyboard (or scrolled with the Data Entry Control). After selecting a note, the third line displays the primary sample number, and the fourth line displays the secondary sample number associated with the note on line two. After pressing ENTER, the zone selection process is complete and the ESI returns to the Module Identifier.

1. Setup

This module establishes the controls for several functions, including tuning, delay before onset of a note, and chorus on/off.

1. **Activate Dynamic Processing module.**
2. **Select Setup Submodule (1).**
3. **Move the cursor to the parameter(s) to be adjusted, and select the desired value(s) with the Data Entry Control.** The display shows:

DYNAMIC SETUP	
Tuning:	+0.0 cents
Delay:	0.000s
Chorus:	off

- **Tuning:** varies the zone pitch over a range of -100 to +100 cents. (One hundred cents equals 1 semitone.)
- **Delay:** varies the time between when a MIDI Note On message is received and the onset of the note up to 1.53 seconds.
- **Chorus:** “thickens” the sound by doubling the primary sample and detuning the doubled sample somewhat. Chorus uses two channels. When chorus is on, the number of available channels in the zone will be cut in half. Chorus cannot be used with stereo samples.

APPLICATION: Creating an Alternate Tuning “Template.”

1. Tune each key by selecting it as a zone and then adjust the tuning.
2. To use the “template” with other samples, load in new samples to the existing sample numbers.
3. Return the samples to their true pitches using the Original Key function.

4. **Select page two by pressing the right cursor button.** The second page displays the following parameters for the selected zone.

DYNAMIC SETUP	
Original Key:	E0
S01 Piano	E1

! Caution: *If there are no samples in the selected zone, the ESI will return to the beginning of the zone selection process.*

- **Original Key:** allows you to change the original key of any samples in the selected zone.
 - **Change Sample Number:** allows you to reassign any sample in the bank to the selected zone.
5. **Select page three by pressing the right cursor button.** The third page displays the following parameters for the selected zone.

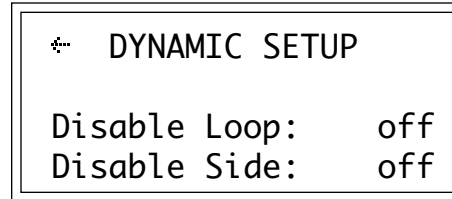

- **Disable Loop:** turns off the loop for any samples within the selected zone for the current preset and overrides any loop settings made in the Digital Processing module for the current preset.
 - **Disable Side:** turns off playback of either the left or right side of a stereo sample within the selected zone.
6. **Press ENTER to exit the submodule.** The ESI will return to the Module Identifier.

2. VCA

The Voltage Controlled Amplifier (VCA) submodule contains two pages. Page one sets the overall zone level and stereo placement (pan). Page two sets the AHDSR envelope characteristics that alter VCA dynamics with respect to time.

1. **Activate Dynamic Processing module.**
2. **Select submodule VCA (2).**
3. **Move the cursor to the parameter(s) to be adjusted, and select the desired value(s) with the Data Entry Control.** The first page reads:

! Caution: When VCA Level is set to 100%, additional modulation from pedals, LFOs, etc. will not increase the level. You must reduce the VCA level from the 100% mark for additional modulation to have any effect.

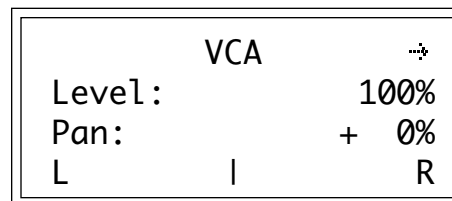

- **Level:** is variable from -100% to 100%.
- **Pan:** is continuously variable from +100, where the zone appears at the right extreme of the stereo image; through 0, where the zone appears at the center of the stereo image; to -100, where the zone appears at the left extreme of the stereo image. The display graphically indicates the stereo position on the bottom line. The initial placement may have to be adjusted as modulation is applied to pan.

4. Select page two by pressing the right cursor button. The second page displays the following parameters for the VCA AHDSR envelope generator:

VCA Attack:	0.00s
Hold:	0.00s
Decay:	0.00s
Sus:100% Rel:	1.04s

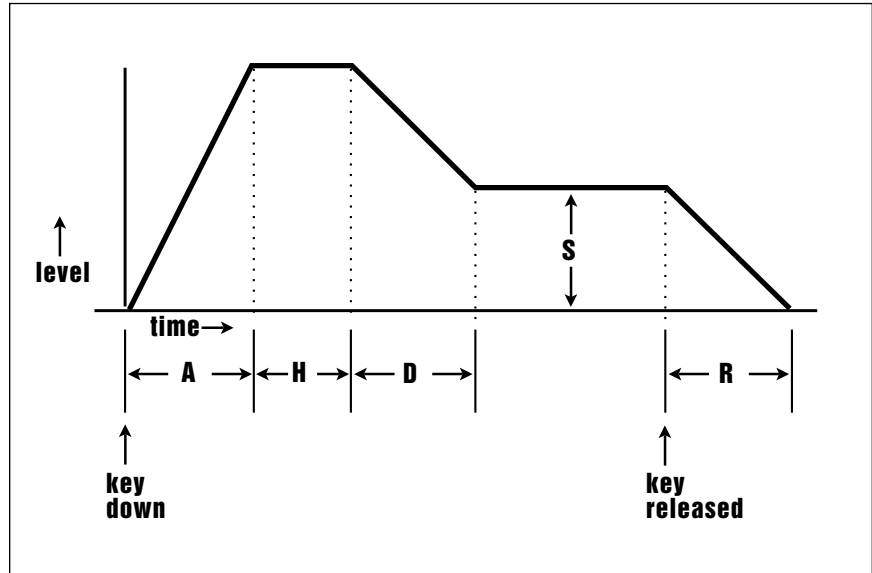

AHDSR ENVELOPE STAGES. If the key is released during the Hold or Decay stages, the Release stage begins.



Piano

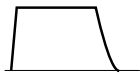

Organ

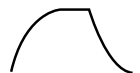

Strings



Percussion

The amplitude envelope shape gives important clues to the ear about what type of sound is being produced.

Refer to the following diagrams and definitions to understand how each parameter affects dynamics.

- **Attack:** varies the VCA envelope attack time from 0 to 163.69 seconds.
- **Hold:** sets the duration of the peak, from 0 to 21.69 seconds. If a key is held down longer than the hold duration, the decay phase will begin. If a key is released during the hold duration, the release phase will begin.
- **Decay:** varies the initial decay time from 0 to 163.69 seconds.
- **Sus:** (Sustain) varies the envelope sustain level from 0 to 100% of the peak level.
- **Rel:** (Release) varies the release time from 0 to 163.69 seconds.

5. Press ENTER to exit the submodule. The ESI will return to the Module Identifier.

3. VCF

The Voltage Controlled Filter (VCF) submodule contains three pages. Page one determines the filter, the filter's initial cutoff frequency and Q (resonance). Page two determines the effect of keyboard position on cutoff frequency, and the extent to which the associated AHDSR envelope affects the filter cutoff frequency (envelope amount). Page three sets the VCF AHDSR envelope characteristics. These alter timbre with respect to time.

1. **Activate Dynamic Processing module.**
2. **Select VCF (3).**
3. **Move the cursor to the parameter(s) to be adjusted, and select the desired value(s) with the Data Entry Control.** The first page reveals:

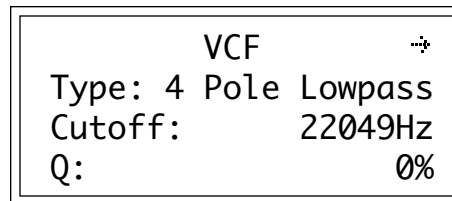

- **Type:** selects the type of filter used. Refer to the Filter Background section earlier in this chapter.
- **VCF Cutoff:** varies the filter cutoff frequency from 0 Hz to 22049Hz. Higher values correspond to higher filter cutoff frequencies, hence a sound with more treble. The maximum filter sweep range is most obvious with envelope amount set to +0.
- **Q:** varies the resonance from 0 to 100%. Higher values correspond to increased resonance, which accentuates the frequency response at the filter cutoff frequency. This produces a sharper, more whistling sound.

4. **Select page two by pressing the right cursor button.** The second page shows:

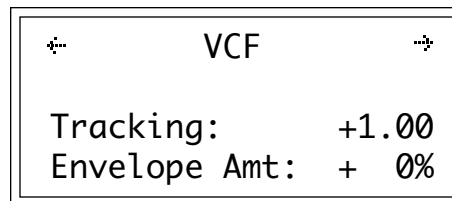

- **Tracking:** varies the filter cutoff with respect to the note(s) being played on the keyboard from -2.00 to +2.00. With 0.00 tracking, the filter cutoff will not be affected by the keyboard pitch. With tracking set to -2.00, the filter cutoff increases at one-quarter the rate at which pitch increases. With tracking set to +2.00, the filter cutoff increases at twice the rate at which pitch increases. Intermediate values give intermediate degrees of tracking. With negative tracking, a sample becomes progressively less bright as you play higher up in the zone. This is useful with some bass sounds, and to even out frequency response variations between samples when multi-sampling.

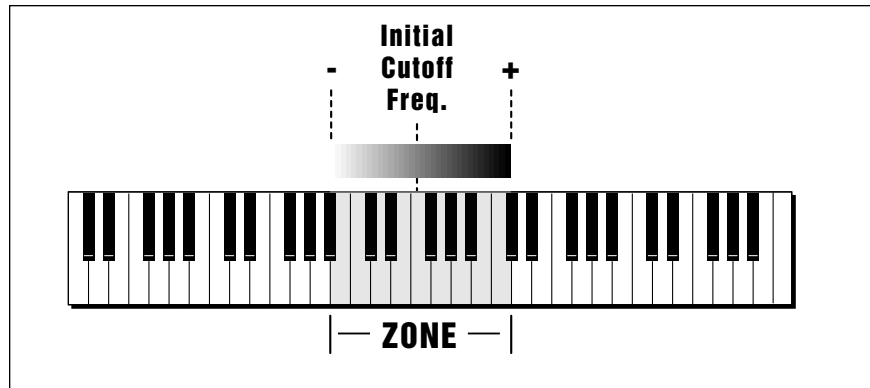

Keyboard Tracking varies the filter cutoff frequency as you play up and down the keyboard.

With 0.00 tracking, a sample's timbre remains constant over the selected zone. This generally gives the most realistic synthesizer and instrument sounds. With positive tracking, the sample's timbre becomes brighter as you play higher up in the zone.

- **Envelope Amt:** varies the effect of the filter envelope on the filter cutoff frequency from -100, which is the maximum inverted envelope, through +00, which has no effect from the envelope, to +100, which is the maximum positive envelope. It is usually necessary to raise the filter cutoff value when using inverted envelopes.

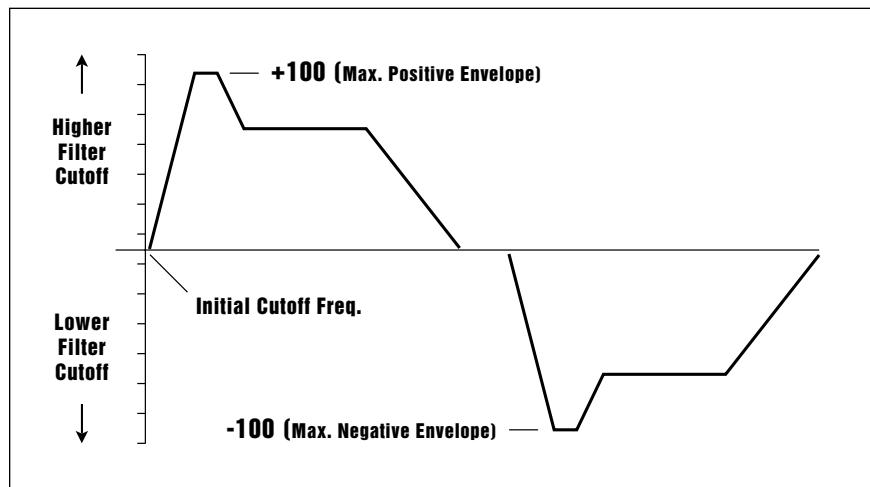

The filter cutoff frequency can be modulated with a positive or negative envelope amount.

5. **Select page three by pressing the right cursor button.** The third page displays the following parameters for the VCF AHDSR envelope generator:

✦ VCF Attack:	0.00s
Hold:	0.00s
Decay:	0.00s
Sus:100% Rel:	1.04s

- **Attack:** varies the VCA envelope attack time from 0 to 163.69 seconds.
- **Hold:** sets the duration of the peak, from 0 to 21.69 seconds. If a key is held down longer than the hold duration, the decay phase will begin. If a key is released during the hold duration, the release phase will begin.
- **Decay:** varies the initial decay time from 0 to 163.69 seconds.
- **Sus:** (Sustain) varies the envelope sustain level from 0 to 100% of the peak level.
- **Rel:** (Release) varies the release time from 0 to 163.69 seconds.

6. **Press ENTER to exit the submodule.** The ESI returns to the Module Identifier.

4. LFO

A Low Frequency Oscillator (LFO) is a wave which repeats at a slow rate. The LFO waveforms in ESI are Triangle, Sine, Square and Sawtooth. If using LFO to modulate the pitch of an instrument, the waveform determines the course of the pitch. For example, a Sine wave is smooth and therefore smoothly changes pitch. The Square waveform changes abruptly causing the pitch to change abruptly.

The LFO submodule contains three pages. Page one sets the LFO rate, shape of the LFO waveform, and the delay before onset of modulation. Pages two and three determine the degree to which the rate is varied as you play different notes (LFO variation), the LFO's destination(s): pitch (which produces vibrato), the VCF cutoff, the VCA amplitude (produces tremolo—attention surf music and Bo Diddley fans), and panning (spatial modulation). The amount of modulation sent to each destination is variable from 0 to 100%.

1. **Activate Dynamic Processing module.**
2. **Select the LFO submodule (4).**
3. **Move the cursor to the parameter(s) to be adjusted, and select the desired value(s) with the Data Entry Control.**

LFO		↔
Rate:	4.25Hz	
Shape:	triangle	
Delay:	0.00s	

- **LFO Rate:** varies the LFO speed from 0.08 Hz to 18.14 Hz.
- **LFO Shape:** selects the waveshape of the LFO. The available LFO waveforms are: triangle, sine, sawtooth and square.
- **LFO Delay:** sets the amount of time between hitting a key and the onset of modulation. This simulates an effect often used by string players, where the vibrato is brought in only after the initial note pitch has been clearly established. The delay range is from 0 to 21.69 seconds.

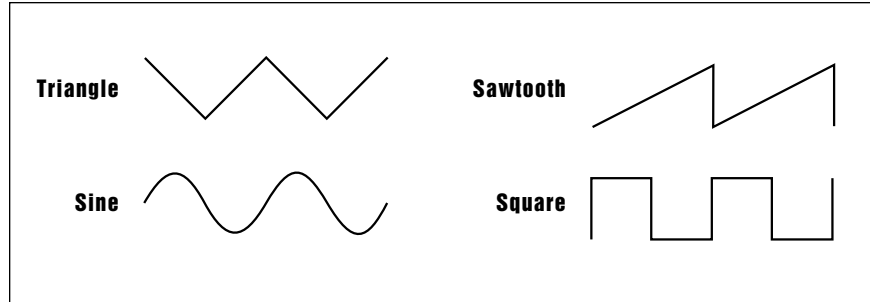

LFO Waveforms.

4. Select page two by pressing the right cursor button. The second page shows:

! Caution: The LFO routing will be ignored if a realtime controller is assigned to the same destination. For example, if you have routed LFO->Pitch in this screen, and then route the mod. control to LFO->Pitch, the setting made in this screen will be ignored.

LFO	
Variation:	0%
LFO->Pitch:	0%
LFO->Cutoff:	0%

- **LFO Variation:** provides a way to create the illusion of multiple players, each having an individual modulation rate. The depth of LFO modulation applied to each parameter is variable from 0 to 100%. With 0% variation, each key will have the same LFO rate. Increasing variation (to a maximum of 100%) alters the LFO rate for each key you play. The higher the number, the greater the variation in LFO rate. For effects such as ensemble playing, the variation feature is invaluable.
- **LFO ->Pitch:** produces vibrato effects.
- **LFO ->Cutoff:** varies the VCF's cutoff frequency in a cyclic fashion. This is useful for adding shimmering effects to a sound.

5. Select page three by pressing the right cursor button. The third page displays the following LFO routing options:

! Caution: When VCA Level is set to 100%, additional modulation from pedals, LFOs, etc. will not increase the level. You must reduce the VCA level (Dynamic Processing, 2) from the 100% mark for additional modulation to have any effect.

LFO	
LFO->VCA:	0%
LFO->Pan:	0%

- **LFO -> VCA:** produces tremolo effects by altering the overall level of a zone in a cyclic fashion.
- **LFO -> Pan:** cyclically varies the placement of the audio output of a zone within the stereo field.

6. Press ENTER to exit the submodule. The ESI returns to the Module Identifier.

5. Auxiliary Envelope

An envelope is described as a contour used to shape a sound over time. The Auxiliary envelope is a general purpose envelope that can be placed at any of several points in the Dynamic Processing signal path. This submodule contains two pages. Page one establishes the auxiliary envelope destination and amount, and page two determines the AHDSR envelope characteristics.

1. **Activate Dynamic Processing module.**
2. **Select the submodule Auxiliary Envelope (5).**
3. **Move the cursor to the parameter(s) to be adjusted, and select the desired value(s) with the Data Entry Control.** The first page shows:

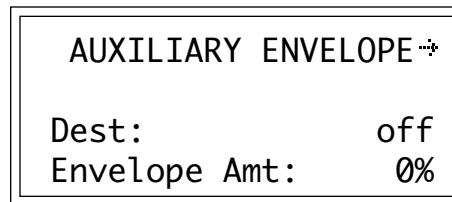

- **Destination:** determines which parameter will be controlled by the envelope. These are: Pitch, Pan, LFO rate, or one of the four LFO destinations (LFO->Pitch, LFO->VCA, LFO->VCF, LFO->Pan). Using the auxiliary envelope to control pitch gives automatic pitch-bending. Controlling the LFO rate can increase (or decrease) the LFO speed over the duration of a note. Adding envelope control to an LFO destination allows modulation to fade in or out over the duration of a note.
 - **Envelope Amt:** varies the depth of the envelope's effect on the chosen destination. It is variable from -100, the maximum inverted envelope, through +00 (no effect from the envelope), to +100, the maximum positive envelope. When using inverted envelopes, it is usually necessary to raise the LFO depth for the destination selected in step 5 of Dynamic Processing, 4. LFO.
4. **Select page two by pressing the right cursor button.** The second page displays the following parameters for the auxiliary AHDSR envelope generator:

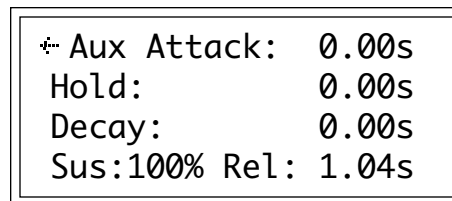

The envelope parameters are identical to the VCF and VCA envelopes.

5. **Press ENTER to exit the submodule.** The ESI returns to the Module Identifier.

6. Velocity To

Velocity data from your MIDI keyboard, sequencer or other controller can control any or all of nine different parameters, as selected on three pages in this submodule.

1. Activate Dynamic Processing module.
2. Select Velocity To (6).
3. Move the cursor to the parameter(s) to be adjusted, and select the desired value(s) with the *Data Entry Control*. The first page shows:

★ **Tip:** Since each zone can have its own keyboard velocity settings, lower register bass sounds can have minimum dynamics to provide a constant bottom, while upper register lead sounds can be played more dynamically.

VELOCITY TO		↔
Pitch:	+ 0%	
VCA Level:	+ 0%	
VCA Attack:	+ 0%	

Values are adjustable from -100% to +100%.

- **Pitch:** ties velocity to pitch. With negative values, playing more forcefully lowers pitch. With positive values, playing more forcefully raises pitch.
- **VCA Level:** ties velocity to overall amplitude. At 0%, the overall level remains at the maximum level set in Dynamic Processing, VCA (2), and produces the loudest possible dynamics, no matter how forcefully or softly you play the keyboard. Progressively higher positive values give a progressively wider dynamic range by lowering the level as you play more softly (standard dynamics). Progressively higher negative values give a progressively wider dynamic range by lowering the level as you play more forcefully (reverse dynamics). Use velocity to add dynamics to sampled sounds that don't contain dynamics, such as samples from older synthesizers.
- **VCA Attack:** ties velocity to the VCA envelope attack time. With negative values, playing softly gives shorter attack times and playing more forcefully lengthens the attack. With positive values, playing softly gives longer attack times, while playing more forcefully shortens the attack. VCA attack is useful for string and horn sounds, where bowing or blowing softly produces a slower attack than rapid bowing or blowing, which produces a much faster attack.

! **Caution:** When VCA Level is set to 100%, additional modulation from pedals, LFOs, etc. will not increase the level. You must reduce the VCA level (Digital Processing, 2) from the 100% mark for additional modulation to have any effect.

★ **Tip:** The VCA Attack settings interact with the VCA AHDSR attack time setting (Dynamic Processing, 2). You will probably need to fine tune the AHDSR attack time setting for optimum results.

4. Select page two by pressing the right cursor button. The second page shows:

↔	VELOCITY TO	↔
VCF Cutoff:	+0%	
VCF Q:	+0%	
VCF Attack:	+0%	

★ **Tip:** The Cutoff and Q settings interact with the VCF controls (Dynamic Processing, 3). You will probably need to fine tune the VCF settings for optimum results.

- **VCF Cutoff:** ties velocity to the filter cutoff frequency. At 0%, the cutoff remains as set in Dynamic Processing, VCF (3), no matter how forcefully or softly you play the keyboard. Progressively higher positive values give a progressively wider cutoff frequency range by lowering the cutoff as you play more softly. Progressively higher negative values give a progressively wider cutoff frequency range by lowering the cutoff as you play more forcefully. Acoustic instruments often sound brighter when played forcefully. You can simulate this effect by tying VCF Cutoff to keyboard dynamics.
- **VCF Q:** ties velocity to filter Q. At 0%, the Q remains as set in Dynamic Processing, VCF (3), no matter how forcefully or softly you play the keyboard. Progressively higher positive values give a progressively wider Q range by lowering the Q as you play more softly. Progressively higher negative values give a progressively wider Q range by lowering the Q as you play more forcefully. Increasing Q thins out a sound, yet also increases its sharpness. Tying this to velocity can work well with percussive samples when you want a more intense, but not necessarily louder, sound. Overall volume levels can change with changes in Q; this is normal.
- **VCF Attack:** ties velocity to VCF envelope attack time. With negative values, playing softly gives shorter attack times, while playing more forcefully lengthens the attack. With positive values, playing softly gives longer attack times. And, as you might expect by now, playing more forcefully shortens the attack.

5. **Select page three by pressing the right cursor button.** The third page displays:

⚙️ VELOCITY TO		
Pan:	+	0%
Sample Start:	+	0%
Auxiliary Env:	+	0%

- **Pan:** ties velocity to stereo placement. At 0%, the Pan position remains as set in Dynamic Processing, VCA (2) no matter how forcefully or softly you play the keyboard. Progressively higher positive values shift the stereo image further to the right as you play more forcefully. Progressively higher negative values shift the stereo image further to the left as you play more forcefully. The higher the value, the greater the difference in stereo spread between soft and forceful keyboard playing.
- **Sample Start:** ties velocity to where the sample begins playing when you hit a key. At 0%, the sample plays normally no matter how forceful or soft you play the keyboard. Progressively higher positive values move the sample start point further towards the sample's end, thus cutting off the attack portion of the sample. Progressively higher negative values move the start point backward, beginning at the end of the sample.

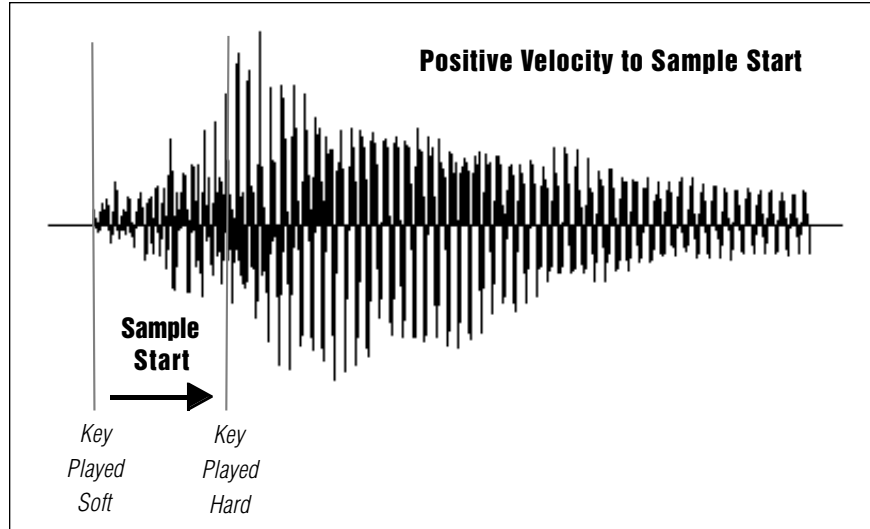

The Velocity to Sample Start parameter allows you to change the attack characteristics of the sample with velocity. This technique is especially effective with percussion samples.

- **Auxiliary Env:** ties velocity to the Auxiliary Envelope's depth. At 0%, the effect of the Auxiliary Envelope remains as set in Dynamic Processing, Auxiliary Envelope (5) no matter how forceful or soft you play the keyboard. Progressively higher positive values increase the envelope depth as you play more forcefully. Progressively higher negative values decrease the envelope depth as you play more forcefully.

6. Press **ENTER** to exit the submodule. The ESI will return to the Module Identifier.

7. Keyboard Mode

This submodule alters the way the keyboard processes the notes (not the sounds) that you play. Options include a gate or trigger Envelope Mode, a monophonic Solo Mode, and a Nontranspose function for maintaining a constant pitch throughout a zone.

1. Activate Dynamic Processing module.
2. Select Keyboard Mode (7).
3. Move the cursor to the parameter(s) to be adjusted, and select on or off with the Data Entry Control. The first page reads:

KEYBOARD MODE	
Mode:	trigger
Solo:	off
Nontranspose:	off

★ **Tip:** If you have a sound effect layered behind a melodic line, but don't want the effect to transpose as you play the melody, simply Nontranspose the sound effect.

★ **Tip:** Although the ESI version 3.00 is different from version 2.10 in that it is more "legato" in its envelope following, you can get a totally "un-legato" solo mode using one of the Mono Channel assignments. Mono Channel assignments always preserve the attack, even with the unlooped samples.

- **Env Mode:** chooses between gate mode or trigger mode. In gate mode, the AHDSR envelopes react as described earlier. Holding down a key cycles through the AHDS stages, and releasing initiates the Release phase. In trigger mode, pressing a key, however briefly, cycles through the AHR stages and ignores the decay and sustain phases. Trigger mode is usually the best mode to use when triggering the ESI from external drum pads.
 - **Solo:** provides the playing action of a monophonic synthesizer with single triggering and last-note priority. Solo mode produces more realistic effects when working with monophonic instrument sounds such as solo trumpet, flute, or sax, since this mode does not allow you to play a chord.
 - **Nontranspose:** lets a sample play throughout its assigned zone at its original pitch only—there will be no transposition. This is useful when determining the original note at which a sample was recorded. Nontranspose is also useful if you're playing drum parts from the keyboard. Assigning a drum sound to a range consisting of several keys provides an easier target than being forced to hit a single key.
4. **Press ENTER to exit the submodule.** The ESI will return to the Module Identifier.

8. Realtime Control Enable

This function lets you to exempt specific realtime control destinations within a zone from being affected by the realtime controls. Off prevents the realtime control destination from being affected by the realtime controls. On (the default) allows the destinations to be affected by the realtime controls.

Example: Suppose you wanted the pitch wheel to bend only the upper half of the keyboard and not the lower half. Simply select the lower half of the keyboard as the current zone and turn Pitch Off in this screen. That's it!

1. **Activate Dynamic Processing module.**
2. **Select Realtime Enable (8).**
3. **Move the cursor to the parameter(s) to be adjusted, and select On or Off with the Data Entry Control.** The first page reads:

CONTROLLERS ENABLE ↔	
Pitch:	on
VCF Cutoff:	on
VCF NoteOn Q:	on

4. **Select page two by pressing the right cursor button.** The second page controls the following realtime control destinations:

✦ CONTROLLERS ENABLE ✦	
LFO->Pitch:	on
LFO->VCF Cutoff:	on
LFO->VCA:	on

5. Select page three by pressing the right cursor button. The third page controls the following realtime control destinations:

✦ CONTROLLERS ENABLE ✦	
VCA Level:	on
Attack:	on
Pan:	on

6. Press ENTER to exit the submodule. The ESI will return to the Module Identifier.

9. Channel Assignment

This function lets you to restrict the number of output channels assigned to a zone. The “Assign Group” system allows you to assign a certain number of output channels and designate a submix to each zone.

Zones are allowed to use output channels within their assigned group of channels only and do not interfere with other groups. Poly All is the default mode which allows free use of all output channels, but Poly All will not interfere with Zones assigned to other groups. By assigning zones in the preset to groups, important parts can be protected from being “stolen” if ESI's polyphony is exceeded. Alternatively, a zone, such as an open high hat, can be assigned to a mono channel bin so it will be cancelled by a closed high hat assigned to the same group.

The modes are as follows.

- **Poly All:** Poly All is the default group and is used when specific assignments are not needed. Notes are played polyphonically with dynamic channel assignment, using all channels.
- **Poly 16 A-B:** Two groups of 16 channels each. Notes are played polyphonically with dynamic channel assignment, but using no more than 16 channels.
- **Poly 8 A-D:** Four groups of 8 channels each. Notes are played polyphonically with dynamic channel assignment, but using no more than 8 channels.
- **Poly 4 A-D:** Four groups of 4 channels each. Notes are played polyphonically with dynamic channel assignment, but using no more than 4 channels.

- **Poly 2 A-D:** Four groups of 2 channels each. Notes are played polyphonically with dynamic channel assignment, but using no more than 2 channels.
- **Mono A-I:** Nine monophonic channels. Any voices assigned to the same letter interrupt each other, but does not affect other voices.

As an example of how this is used, suppose you have a sequence containing a drum pattern. You want the drum pattern to remain solid and free from stolen channels no matter how complex the sequence. Furthermore, you want the closed high hat to cut off the open high hat to simulate a real drum kit.

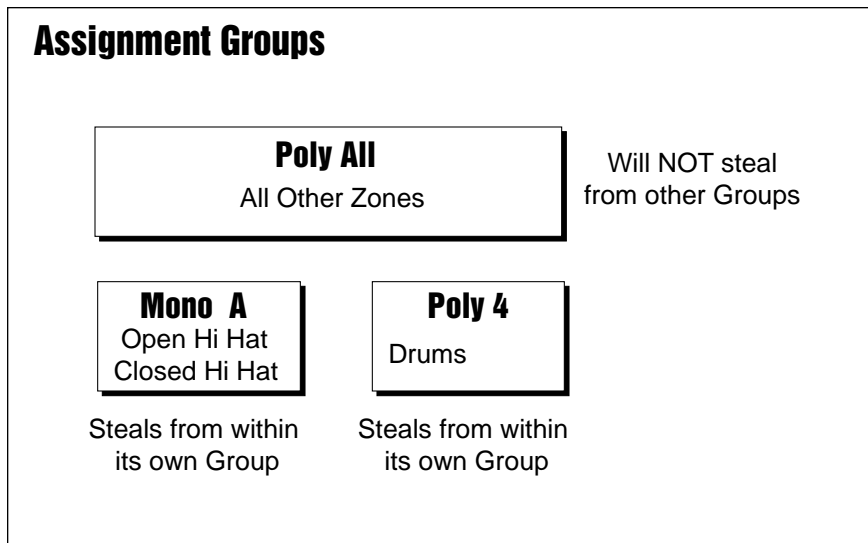

Zones assigned to groups will only steal channels from within that same group. Alternatively, multiple zones can be assigned to the Mono Groups so that selective channel stealing will occur.

- A. Select the zone for the open high hat and assign it to one of the Mono groups (Mono A). Assign the closed hi hat to the same group (Mono A).
- B. Select the zone for the rest of the drums and assign it to the Poly 4 Assignment.

► **To Assign Zones to Assignment Groups:**

1. Press the Dynamic Processing key.
2. Select Channel Assignment (9), The following screen appears.

! Caution: *If a plug is not inserted into a submix jack, any zone assigned to that jack is automatically re-routed to the main outputs.*

```
CHANNEL ASSIGNMENT  
  
AssignGroup:Poly All  
Submix:           main
```

3. Move the cursor down to the third line and **select an Assignment Group**.
4. Move the cursor down to the last line and **select a submix**.
5. **Press ENTER** to exit the submodule. The ESI returns to the Module Identifier.

Effects	215
Effects Parameters	230
Using SCSI	236
Disk Drive Compatibility.....	240
Keyboard Character Chart ...	241
ESI Menu Map	242
MIDI Key Number Chart	243
MIDI Implementation Chart	244
Specifications	245
Error Codes	246
Troubleshooting	248
Warranty	252
Index	253

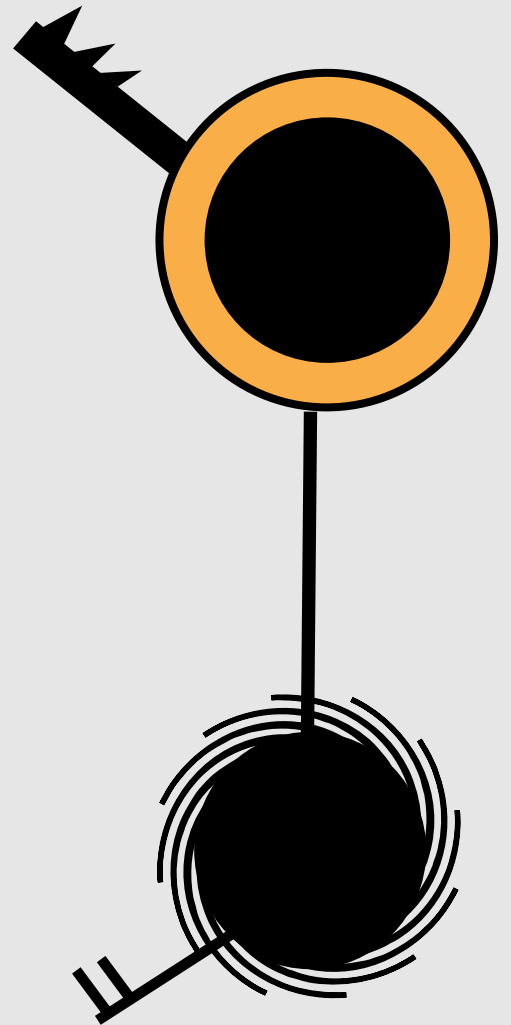

Effects

ESI TURBO

The ESI Turbo option adds exciting new capabilities to your ESI including: two 24-bit stereo digital effects processors with over 70 effect algorithms; S/PDIF digital I/O for interfacing with other digital equipment; and two additional pairs of submix outputs which allow external processing of specific sounds.

The rear panel of the Turbo option contains five jacks.

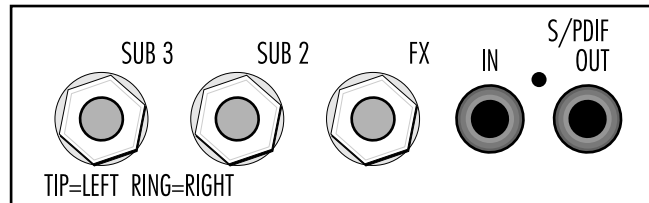

The three phone jacks are the FX and Submix outputs. These are Stereo jacks. The Left channel is on the Tip of the jack and the Right output is on the Ring conductor. Use a stereo "Y" cable to access both channels of these outputs. One stereo Y-cable is included with the Turbo option. Additional Y-cables are available from Radio Shack or from your local electronics supplier.

The FX Output is a copy of the Main Output run through the effects processors. When MIDI channels or Zones are programmed to "Main," they appear at both the FX and Main outputs. The submix outputs incorporate "plug sensing" which reroutes signals to the FX outputs if a plug is not inserted into the submix jack.

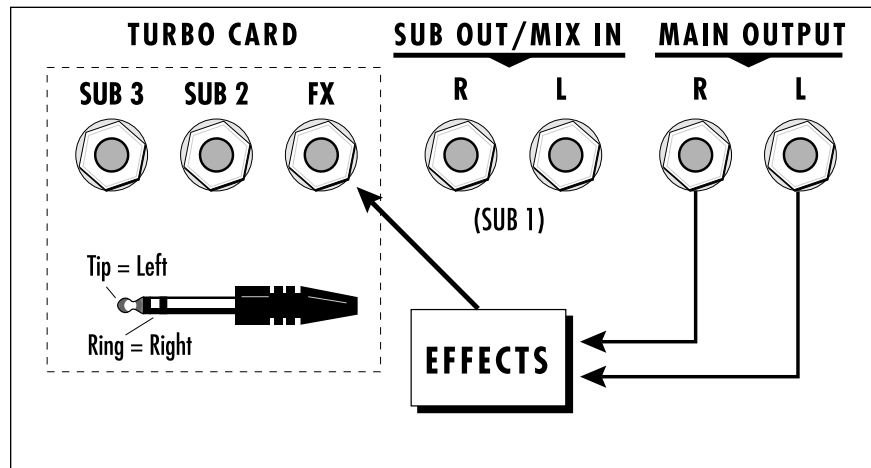

The S/PDIF Input and Output allows the ESI to transfer digital audio back and forth with other digital devices equipped with S/PDIF digital I/O. Keeping the signal in the digital domain is desirable to keep the signal to noise level as high as possible. Using the digital input, you can sample directly from a DAT recorder or external A/D converter. The digital output reflects the data at the FX output and is always active.

Dual Effects Processors

The ESI Turbo option contains two stereo effects processors which serve the entire machine. When playing presets one at a time, the two processors can be programmed as part of the preset. When in multimode, a global effects assignment is used. The diagram below shows how the effects are integrated into the signal path using a parallel effects send/return model, similar to a mixing console.

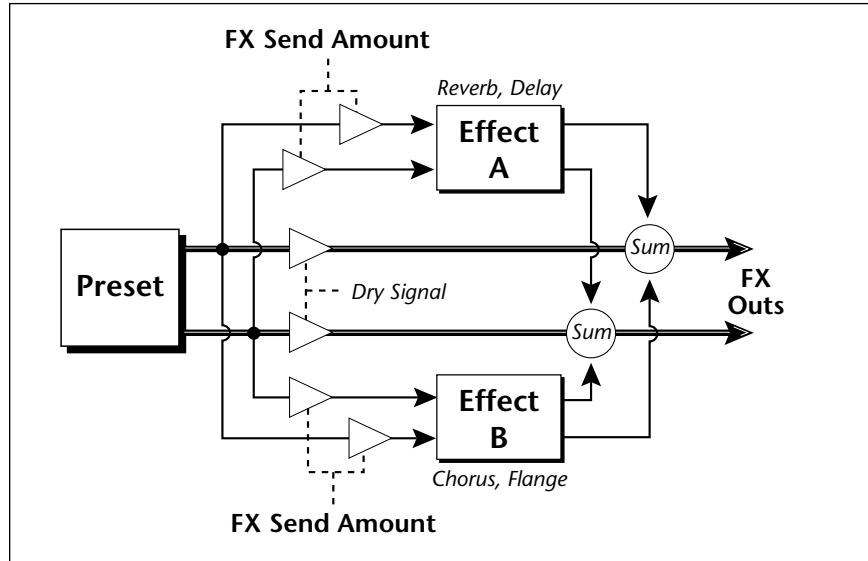

Effects processor “A” contains Reverb and Delay effects and Effects processor “B” contains Chorus, Flange and Distortion effects. There are 44 “A” effects and 32 “B” effects. In addition to the effect type there are user adjustable parameters for each effect. The “A” effects have user programmable Decay Time and High Frequency Damping. The “B” effects have user programmable Feedback, LFO Rate and Delay Time.

■ **Note:** Unlike a mixing console, the dry signal begins to be attenuated as the Send Amount is increased beyond 50%. This allows a mix of 100% effect.

The Effects Sends

On a mixing console you can control the amount of signal each channel Sends to the effects bus. This allows each channel to be placed in a slightly different “sonic space” which can create an airy, open sound.

ESI uses this basic concept, but works in a slightly different manner. There are 4 effects busses: Main, Sub 1, Sub 2, and Sub 3. Zones or MIDI channels (you determine which), can be directed to one of the four busses. Each effects processor contains four Send Amounts which allow you to set the wet/dry mix on each of the four busses going into the effect. A setting of 0% is completely dry (no effect). A setting of 50% contains an equal mix of effected and dry signal.

*Dynamic Processing,
Channel Assignment (9).*

CHANNEL ASSIGNMENT	
AssignGroup:	Poly All
Submix:	main

The submix bus selection can be programmed by Zone in the Dynamic Processing, Channel Assignment screen. These settings can be overwritten in the Master by changing the submix setting from “Z” (Zone) to “Main, Sub 1, 2 or 3” which routes the preset on that MIDI channel to the selected submix bus.

! Caution: You must be in Multimode in order to change channels in the MIDI Mix screen.

In the screen below, MIDI channel 4 is programmed to the submix 1 bus. MIDI channels 2, 3 and 5 obey the submix routing as programmed in each zone.

Master/Global,
MIDI (9), MIDI Mix (1).

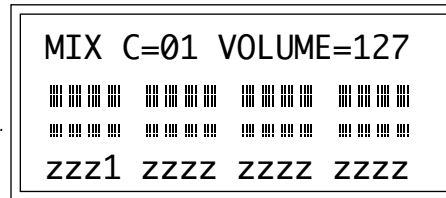

The submix bus routings are also available at the Submix jacks on the rear panel. Note that these outputs contain only Dry signal. The Effects Processors are ONLY connected to the FX Outputs.

If a plug is inserted into a Sub Output jack, the dry signal from that bus is removed from the effects processor. This feature allows you to have three dry mixes from the Sub Outputs and an “Effects Only” mix from the Main Outputs.

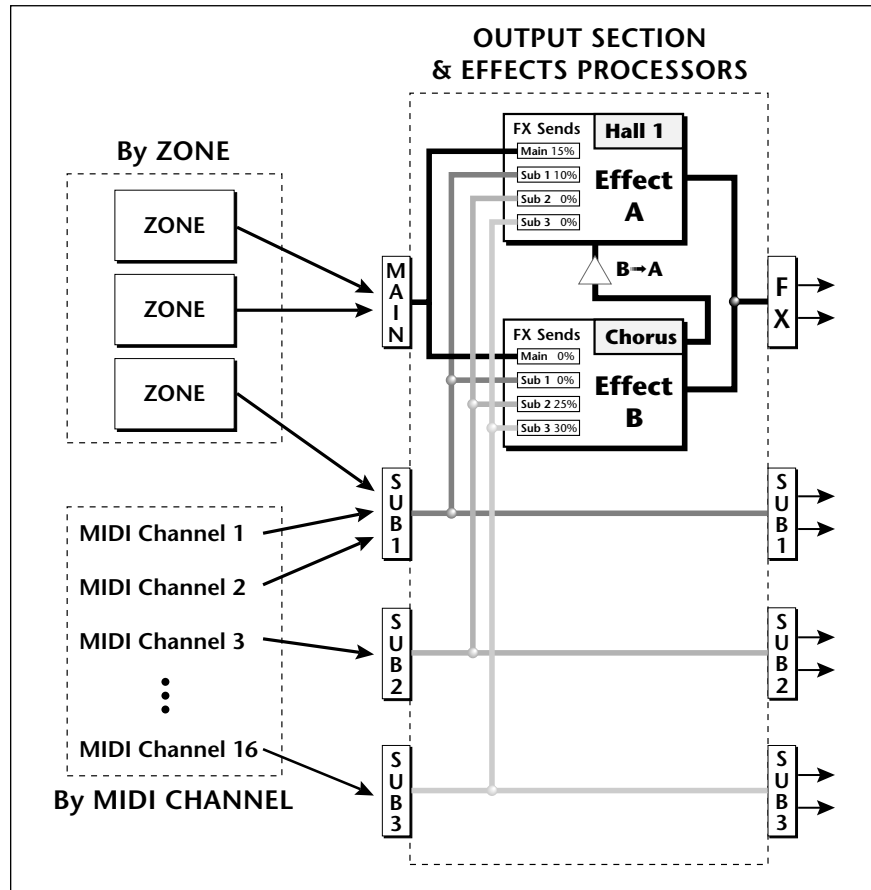

The diagram above shows how individual voices or MIDI channels can be routed to the four busses. Note that the signal lines represent stereo signals.

Three-way Effects Control

The effects processor controls are very flexible. Effects can be controlled three ways to suit your personal preference and to adapt to different situations. The diagram below illustrates the three types of effect control.

1. Programmed as part of the preset when playing single presets (Omni or Poly Modes).
2. Programmed from the Master Effects Section when playing either single presets (preset Effect Type set to “Master”) or when in Multi Mode.
3. Programmed from the designated control preset when in Multi Mode. This allows effects to be changed using MIDI program change commands.

Effects Programmed in the Preset

When playing single presets (Omni or Poly mode) the effects are normally programmed as part of the preset. This allows the effects to be programmed as part of the preset. Because there are only two effects processors for the entire machine, each preset cannot have its own effect in Multimode where up to 16 presets can be played at once.

► To Program the Effects as part of the Preset:

1. Press the **Preset Definition** key. The LED illuminates and the Preset Definition screen appears.
2. Select the **Effects** submenu (9). The Effects menu will appear.
3. Select **Effects A (0)** or **Effects B (1)**.
4. Select an **Effect** using the Data Entry Control or INC/DEC keys. Do not use the “Master Effects” setting as this will cause the Master effects settings to be used.

PRESET EFFECT A	↔
Effect:	Hall 2

5. Press the **Right Cursor** key. The Effect Parameters screen will appear. Set the Decay Time and HF Damping parameters to your preference.

↔ PRESET EFFECT A ↔	
Decay Time:	56
HF Damping:	80
FxB==>FxA:	0

■ **Note:** Effect parameters are described later in the appendix beginning on page 231

6. Press the **Right Cursor** key again to go to the Effect Sends screen.
7. Set the **effect sends amounts** to your preference.

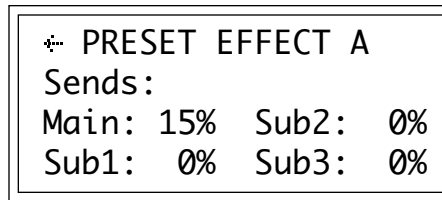

8. Press the Escape key to go back to the main Effects screen. If you want to adjust the Effect B settings, select Preset Effect B (1) and adjust just as you did for the “A” effect.

9. Save the bank. The programmed effects setting will be saved along with the preset.

Master Effects

You might want the effects to be programmed on a global basis in Omni and Poly modes. You could choose your favorite reverb, for example, and have it applied to every preset you select

► To Program the Effects Globally for all Presets:

1. Press the Preset Definition key. The LED illuminates and the Preset Definition screen appears.
2. Select the Effects submenu (9). The Effects menu will appear.
3. Select Effect A (0).
4. Set the Effect to “Master Effects” using the Data Entry Control or INC/DEC keys.
5. Press the Escape key, then select Effect B (1).
6. Set the Effect to “Master Effects” using the Data Entry Control or INC/DEC keys.
7. Press the Master/Global key. The Master/Global menu will appear.
8. Select Effects (4). The main Effect screen will appear.
9. Select Master Effect A (0). The following screen will appear.

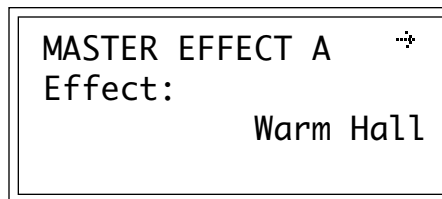

10. Press the Right Cursor key. The Effect Parameters screen appears. Set the effect parameters to your preference.

■ **Note:** Effect parameters are described later in the appendix beginning on page 231

```
✦ MASTER EFFECT A ✦
Decay Time:      40
HF Damping:      64
FxB==>FxA:      0
```

11. Press the **Right Cursor** key again to go to the Effect Sends screen. Set the effect sends amounts to your preference.

```
✦ MASTER EFFECT A
Sends:
Main: 20%  Sub2: 0%
Sub1: 0%   Sub3: 0%
```

12. Press **Enter** to save the system.

If you want to adjust the Effect B settings, press the **Escape** key to go back to the main Effects screen. Select Master Effect B (1) and adjust just as you did for the “A” effect.

Using Master Effects Settings in Multi Mode

In Multi Mode, the two effects processors can be controlled from the Master Effects settings, or they can follow the effects settings of the preset on a special MIDI channel. In this example, the Master Effects will be used. Use this setting if you don't need to change the effects during the song.

► To Use the Master Settings in Multimode

1. Press the **Master/Global** key. The Master/Global menu appears.
2. Select **Effects (4)**. The main Effect screen will appear.
3. Select **Effects Setup (2)**. The following screen will appear.

```
EFFECT SETUP
Effects:      Enabled
Multimode Control:
              master settings
```

4. Select “**master settings**” from the “Multimode Control” field. This causes the Master effects settings to be used.
5. Press **Enter** to lock in the change.
6. Select **Effects (4)** again to adjust the Master Effects. The main Effect screen will appear.
7. Select **Master Effect A (0)**. The following screen will appear.

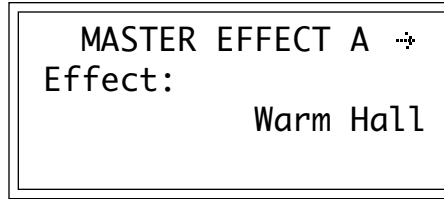

8. Press the Right Cursor key. The Effect Parameters screen will appear. Set the effects parameters to your preference.

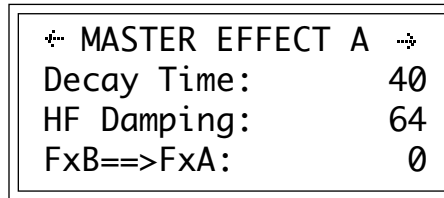

9. Press the Right Cursor key again to go to the Effect Sends screen. Set the Effect Send amounts to your preference.

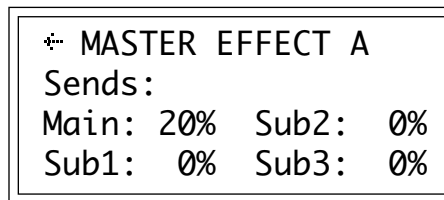

10. If you want to adjust the Effect B settings, press the Escape key to go back to the main Effects screen. Select Master Effect B (1) and adjust just as you did for the “A” effect.

11. Press Enter to save the system.

► To Assign MIDI Channels to the Main Output or to a Submix Bus

★ **Tip:** Refer to the routing diagram on page 217.

In Multimode each MIDI channel can be assigned to the main outputs or to one of the submix busses. If a plug is inserted into a Sub Output jack, the dry signal from that bus is removed from the effects processor. This feature allows you to have three dry mixes from the Sub Outputs and an “Effects Only” mix from the Main Outputs.

This lets you to program a different effect amount for several presets using the same effect. For example, you might want just a touch of reverb on the piano and more on the drums.

1. Select the MIDI submodule (9) from the Master/Global module.
2. Select MIDI Mix (1). The following screen will appear.

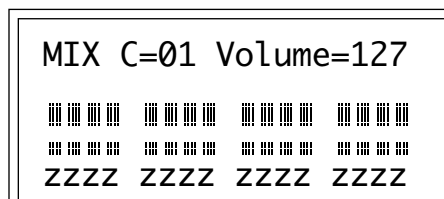

! Caution: You must be in Multimode in order to change channels in the MIDI Mix screen.

3. Use the left/right cursor keys to select a MIDI Channel. Use the Up/Down Cursor keys to select Volume, Pan or Submix output for each MIDI channel. For now move the cursor to the lower line. Each column represents a MIDI channel from 1 to 16, left to right.

4. Use the Data Entry Control or INC/DEC keys to select a submix bus (Main, 1, 2, or 3) for each channel. The amounts for each bus are adjusted in the Master, Effects menu.

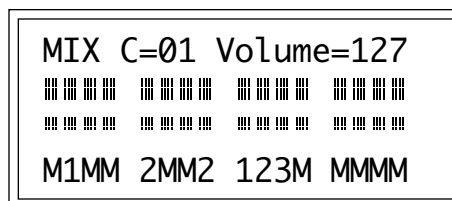

The submix busses can also be programmed by keyboard zone. Using this feature you could assign a different effect to each half of the keyboard or change the effect amount as you play up the keyboard. On a preset containing a drum set, you could have four different effect mixes to assign to each drum. A zone can be any range of keys.

► **To Program Submix Busses by Zone**

- Set the submix bus to “z” using the Data Entry Control or INC/DEC keys. Now the submix bus will be determined by the zone assignments in the preset assigned to that MIDI channel.

► **To set up Submix Assignments in the Preset's Zone:**

1. Exit the Master module.
2. Select the Preset assigned to the channel you set to “Zone” (z).
3. Press the Dynamic Processing key. The LED will illuminate and the Dynamic Processing screen will appear.
4. Select a Zone (0). Define a range of the keyboard by pressing the low key when prompted and then the high key of the range you want.
5. Select the Channel Assignment submodule (9). The following screen will appear.

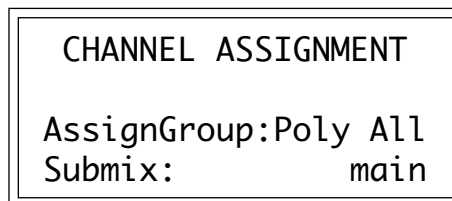

6. Move the cursor to the lower line and select one of the submix busses using the Data Entry Control or INC/DEC keys.

7. To assign another zone, press Escape and go back to the “Select Zone” screen to select a new zone. Then change the submix assignment for the new zone.

8. Save the Bank!

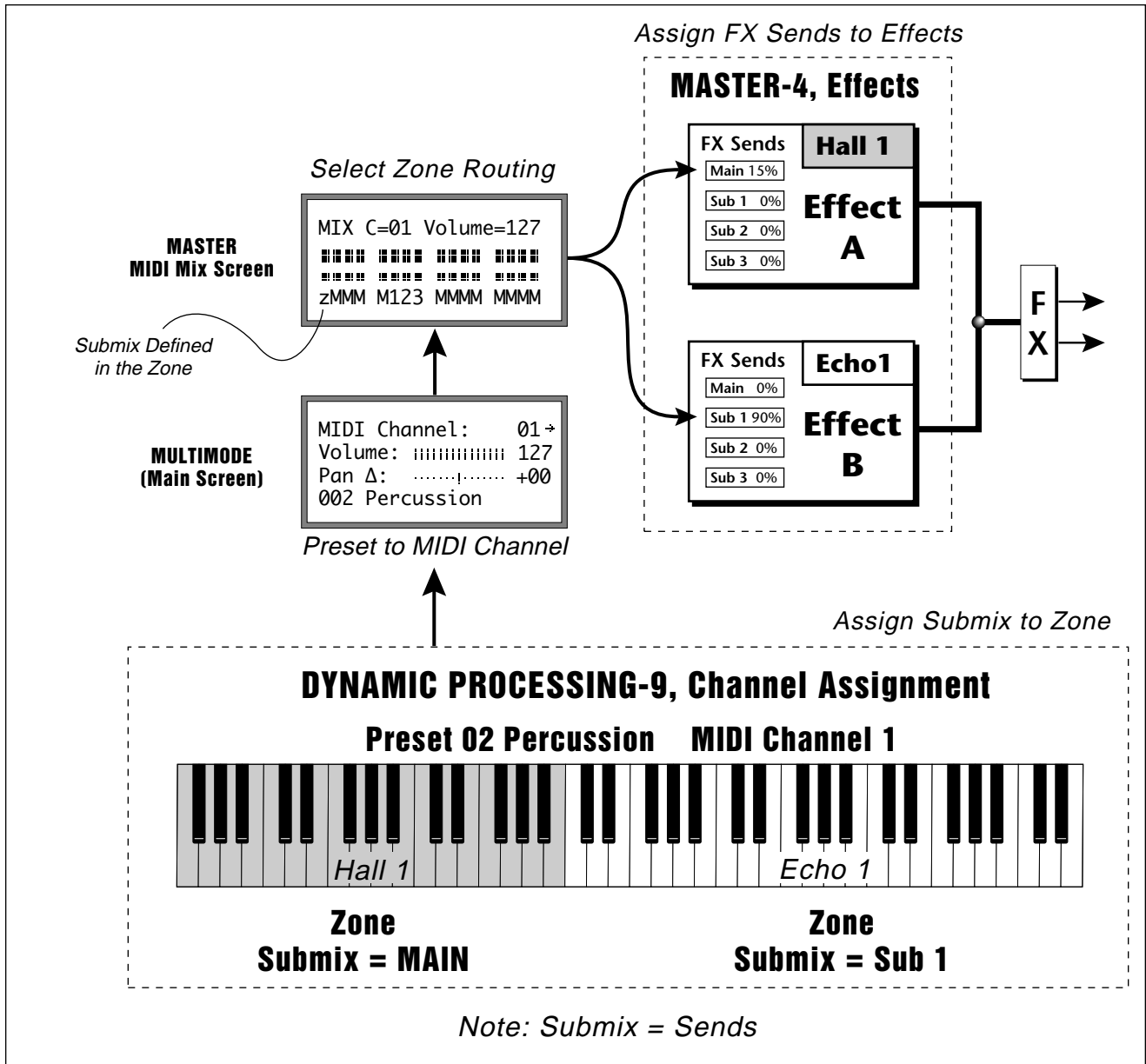

This diagram shows the controls and modules used to assign the effects by keyboard Zone. In this example, the keyboard is split with Reverb on the lower section and an Echo effect on the upper section.

Using the Effects Channel Settings in Multi Mode

In Multi Mode, the effects settings can follow the effects settings of the preset on a special MIDI channel. You designate one MIDI channel as the “Multimode Effects Control Channel.” When this is done, the effects processors follow the effects setting made in the preset assigned to this MIDI channel. This powerful feature allows you to change effects during a sequence simply by changing the preset on the control channel.

Tip: You can create special presets without samples to be used as “Effects Presets”. By assigning these effects presets to the Multimode Effects Control Channel, you can use Program Change commands to switch between effects during a sequence.

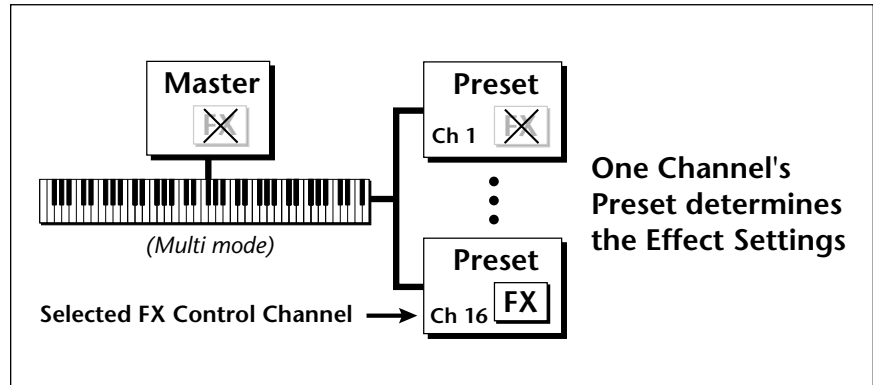

► To Set the Effects Control Channel:

1. Press the Master/Global key. The LED illuminates and the Master/Global menu appears.
2. Select Effects (4). The main Effect screen will appear.
3. Select Effects Setup (2). The following screen will appear.

```
EFFECT SETUP
Effects:      Enabled
Multimode Control:
preset on channel 16
```

4. Move the Cursor down to the “Multimode Control” field. Select “preset on channel X.”
5. Set the channel to the MIDI channel you want to be the effects control channel. The Effects settings programmed in the Preset on this selected channel will be used for ALL the other MIDI channels.
6. Press Enter to save the Master Settings.

Effects Bypass

This control bypasses the effects, turning them off. This feature is useful if you are using external effects at the mixing console and want to turn the effects Off for all presets.

► To Bypass the Effects:

1. **Press the Master key.** The LED illuminates and the Memory Statistics screen appears.
2. **Select Effects (4).** The main Effect screen will appear.
3. **Select Effects Setup (2).** The following screen will appear.

```

EFFECT SETUP
Effects:      Enabled
Multimode Control:
preset on channel 16

```

4. **Set Effects to “Disabled”** using the Data Entry Control or INC/DEC keys.
5. **Press Enter** to save the Master settings.

Effect Descriptions

A EFFECT TYPES

Room 1-3
Hall 1 & 2
Plate
Delay
Panning Delay
Multitap 1
Multitap Pan
3 Tap
3 Tap Pan
Soft Room
Warm Room
Perfect Room
Tiled Room
Hard Plate
Warm Hall
Spacious Hall
Bright Hall
Bright Hall Pan
Bright Plate
BBall Court
Gymnasium
Cavern
Concert 9
Concert 10 Pan
Reverse Gate
Gate 2
Gate Pan
Concert 11
Medium Concert
Large Concert
Large Concert Pan
Canyon
DelayVerb 1-3
DelayVerb 4-5 Pan
DelayVerb 6-9

B EFFECT TYPES

Chorus 1-5
Doubling
Slapback
Flange 1-7
Big Chorus
Symphonic
Ensemble
Delay
Delay Stereo 1 & 2
Panning Delay
Delay Chorus
Pan Delay Chorus 1 & 2
Dual Tap 1/3
Dual Tap 1/4
Vibrato
Distortion 1 & 2
Distorted Flange
Distorted Chorus
Distorted Double

Reverb

Reverberation is a simulation of a natural space such as a room or hall. The reverb effects simulate various halls, rooms and reverberation plates. In addition, there are several other reverb effects such as Gated Reverbs, Multi Tap (early reflections), Delay and Panning effects. There are two adjustable parameters on the reverb effects, Decay Time and High Frequency Damping.

Decay Time is the time it takes for the reflected sound from the room to decay or die away. The diagram below shows a generalized reverberation envelope.

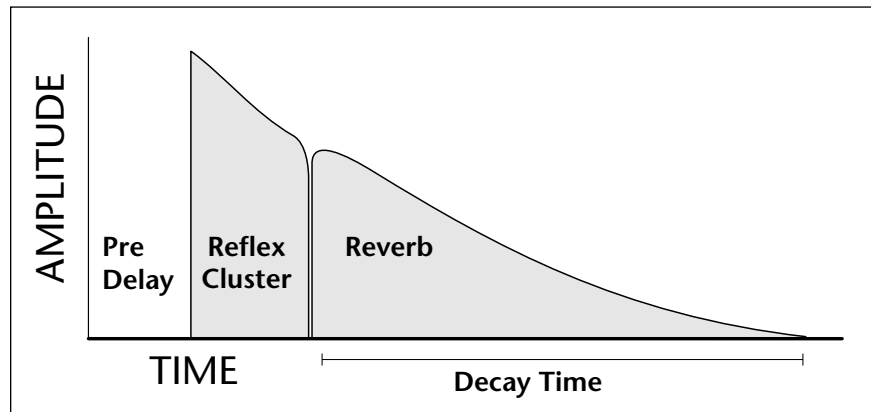

After an initial pre-delay period, the echoes from the closest walls or ceiling are heard. These first echoes, or the early reflection cluster, vary greatly depending on the type of room. Roughly 20 milliseconds after the early reflection cluster the actual reverberation begins and decays according to the time set by the Decay Time parameter.

High frequency energy tends to fade away first as a sound is dissipated in a room. The High Frequency Damping parameter allows you adjust the amount of High Frequency Damping and thus change the characteristics of the room. Rooms with smooth, hard surfaces are more reflective and have less high frequency damping. Rooms filled with sound absorbing materials such as curtains or people have more high frequency damping.

General Descriptions

Room programs simulate small rooms with high frequency absorption caused by drapes and furniture.

Plates simulate plate type reverbs with their tight, dense early reflections and sharp reverb buildup.

Hall programs recreate the open, spacious ambience of large concert halls.

Gated Reverbs add ambience only while the original signal is still sounding. As soon as the signal falls below a threshold, the reverb is automatically cut off.

Delay programs can be used to create echo and doubling effects.

Multi Tap programs consist of the reflection cluster only without the reverb decay.

Chorus

The function of a chorus device is to thicken the sound or to make one voice sound like many. This effect is achieved by mixing one or more delayed versions of the signal in with the original. The delay times used are too short to be perceived as an echo, but long enough so that comb filtering does not occur. In addition, the delay time is varied via a low frequency oscillator to simulate the random differences that occur when multiple instruments are playing together. A slight amount of feedback improves the effect by creating multiple images of the sound as it recirculates again and again.

All the choruses are true stereo using two separate delay lines controlled by a single set of controls. The delay times are slightly different for each channel and the LFO phase is inverted on one channel to help contribute to the overall chorus effect. The LFO Rate and Depth settings are critical to achieving a realistic effect with faster LFO rates generally requiring less LFO amount and vice-versa.

Doubling

When a copy of a sound, delayed by about 26 milliseconds, is added back with the original, two audio images can be perceived by the brain. When the delayed image is slightly varied or modulated, the illusion of two voices is created.

Slapback

Slapback is a single short echo in the range of 50-60 milliseconds. A sound delayed by this length of time is perceived as a discrete and separate image which is useful for a thickening effect or as a pre-delay for reverb simulating a hard, reflective surface such as a gymnasium wall.

Stereo Flanger

A flanger consists of a short audio delay line whose output is mixed together with the original signal. Mixing the delayed and original signals results in multiple frequency cancellations called a comb filter. Since the flanger is a type of filter, it works best with harmonically rich sounds.

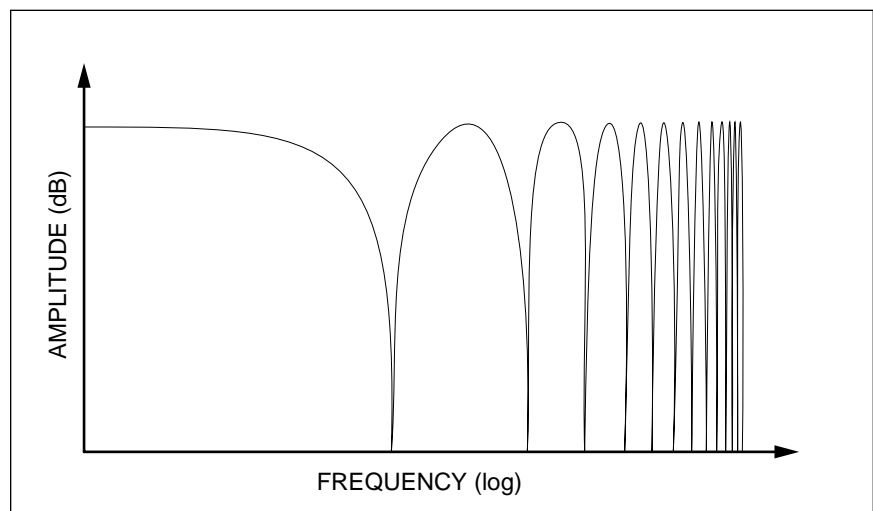

Flanging was originally created using two tape recorders playing identical recordings. By exactly synchronizing the two decks and then slowing the speed of one by grasping the tape reel flanges, the flanging effect was born.

The flanger is a stereo device consisting of two separate delay lines controlled by a single set of controls. A Low Frequency Oscillator (LFO) varies this initial delay setting, changing the frequency of the notches and adding animation to the sound. LFO Rate controls the rate of change and LFO Depth controls how much the LFO changes the delay.

The Feedback control sends some of the delayed signal through the delay line again. When feedback is used the comb filter notches are deepened.

Delay

Delay is an effect which can be used for doubling, reverb pre-delay, or echoes.

Delay Time is variable from 0-635 milliseconds (mS) and controls the time between echoes and Feedback controls how long the echoes continue sounding. “Infinite” delay effects are possible without the risk of runaway because of an automatic gain control in the feedback path.

Stereo Delay

Similar to delay except that the delay line outputs a stereo signal from the mono input. The two output signals are a few milliseconds apart to create a stereo image. The delay times is variable from 0-635 mS.

Panning Delay

A panning delay is similar to the normal delay lines except that the echoes bounce back and forth between the two stereo speakers.

Dual Tap

These are delay lines where the signal is “tapped off” at two unevenly spaced locations. When feedback is used, multiple complex echoes are produced. The fraction in the name (i.e. 1/3, 1/4) refers to the distance between the taps.

Vibrato

Basically, this a delay line modulated by an LFO, but with none of the original signal added in. The LFO modulation creates a Doppler shift and a resultant cyclical pitch shift. The vibrato created in this manner sounds very different than vibrato created by frequency modulating the sample.

Distortion

Distortion uses a technique called “soft-clipping” to create additional harmonics in the signal. As the level increases, the top of the waveform becomes somewhat squared. As the level increases further, it transforms into a true square wave.

Effect Parameters

The Effect parameters allow you to control the most important aspects of the effect. The parameters for the “A” effects are: Decay Time, High Frequency Damping and Effect B through Effect A. The parameters for the “B” effects are: Feedback, LFO Rate and Decay Time.

The effects parameters are located in both the Master and Preset Definition menus. The settings used depend on whether you are using Preset Effects or Master Effects. In the following descriptions we will assume you are using the Preset Effects.

Decay Time

This parameter sets the length of time it will take an effect to fade away. In the case of reverb, decay time controls the room size and the reflectivity of the room. On a delay effect, decay time controls how many echoes are produced or how long the echoes will last.

■ **Note:** *If the Preset Effects settings are currently selected, a pop up warning screen will inform you of this fact and ask if you wish to switch to Master effects.*

1. **Press the Preset Definition key.** The LED illuminates and the Preset Definition menu appears.
2. **Select Effects (9).** The main Effect screen appears.
3. **Select Preset Effect A (0).** The following screen appears.

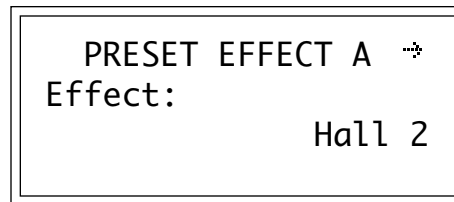

4. **Select one of the effects** using the Data Entry Control or INC/DEC keys.
5. **Press the Right Cursor key.** The Effect Parameters screen appears.

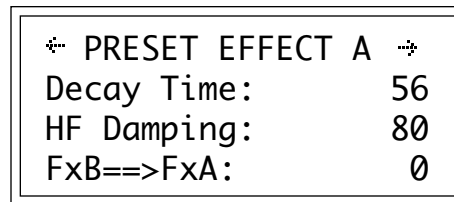

6. **Adjust the Decay Time** as desired.
7. **Press the Preset Definition key** to return to the main menu.

FX A Parameters

HF Damping

High frequency energy tends to fade away first as a sound is dissipated in a room. This parameter allows you adjust the amount of high frequency damping and thus change the characteristics of the room. Rooms with smooth, hard surfaces are more reflective and have less high frequency damping. Rooms filled with sound absorbing materials such as curtains or people have more high frequency damping.

1. Press the **Preset Definition key**. The LED illuminates and the Preset Definition menu appears.
2. Select **Effects (9)**. The main Effect screen will appear.
3. Select **Preset Effect A (0)**. The following screen appears.

```
PRESET EFFECT A  ↵
Effect:
                Tiled Room
```

4. Select one of the effects using the Data Entry Control or INC/DEC keys.
5. Press the **Right Cursor key**. The Effect Parameters screen appears.

```
↵ PRESET EFFECT A  ↵
Decay Time:        48
HF Damping:        64
FxB==>FxA:        0
```

6. Move the Cursor down to the second line and **adjust the High Frequency Damping** as desired.
7. Press the **Preset Definition key** to return to the main menu.

Effect B Into Effect A

The output of effects processor B can be routed into effects processor A. This connects the effects in series instead of their normal parallel configuration. Two effects connected in a series sound very different than the same two effects in parallel. For example, a chorus patched through reverb can turn a bland string section into a lush wall of sound. The B→A amount can also be controlled for even more flexibility.

► To Send the Output of Effect B through Effect A:

In this example, 100% of Effect B will be sent into Effect A.

1. Press the **Preset Definition key**. The LED illuminates and the Master screen appears.
2. Select the **Effects submenu (4)**. The Effects menu will appear.
3. Select **Master Effects A (0)**.

4. **Select an Effect** using the Data Entry Control or INC/DEC keys. Do not use the “Master Effects” setting as this will cause the Master effects settings to be used.

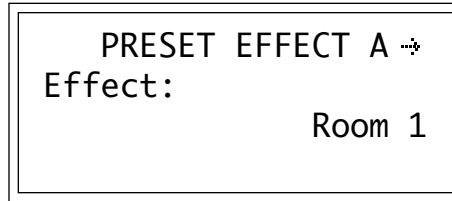

5. Press the Right Cursor key to go to the second screen.

6. Cursor down to the third line of the display and **set the FxB->FxA amount to 127.**

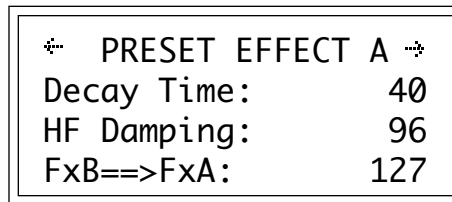

7. Press the Right Cursor key **again** to select the Send Amount screen.

8. **Turn the Send Amounts down to zero** since we only want to hear the two effects in series.

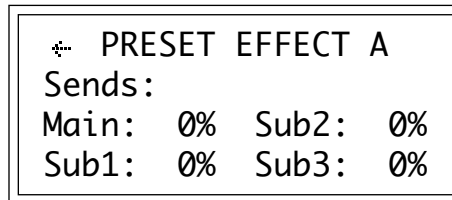

9. Press the ESCAPE key to return to the Effects submenu.

10. Press the Right Cursor key to select Master Effect B.

11. Select an effect as before, then adjust the Main FX A Send percentage as desired.

■ **Note:** Because the amounts are Sends, we want to open the Main Send to Effect B, turn B→A up full and turn the Main Send to Effect A down to zero. This sends ALL of Effect B through Effect A.

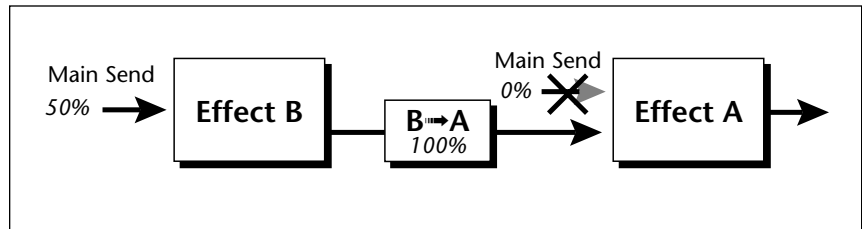

12. **Play the keyboard** and you should hear the B Effect running through Effect A. This patch is shown in the illustration above.

FX B Parameters

Feedback Amount

The Chorus and Flange effects have a controllable feedback loop after the delay element. Feeding back a small amount of the signal intensifies the effect by creating multiple cancellations or images.

1. Press the **Preset Definition** key. The LED illuminates and the Preset Definition menu appears.
2. Select **Effects** (9). The main Effect screen appears.
3. Select **Preset Effect B** (1). The following screen appears.

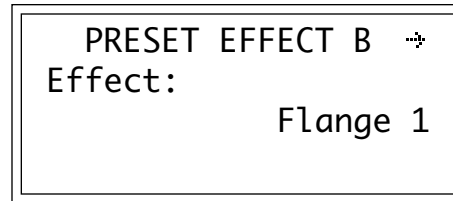

4. Select one of the effects using the Data Entry Control or INC/DEC keys.
5. Press the **Right Cursor** key. The Effect Parameters screen appears.

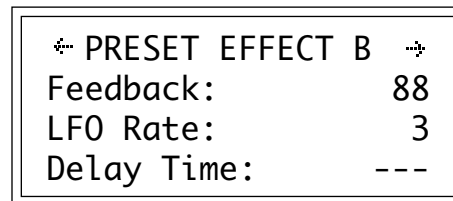

6. Move the Cursor down to the second line and **adjust the Feedback** as desired.
7. Press the **Preset Definition** key to return to the main menu.

LFO Rate

Chorus and Flange effects use a Low Frequency Oscillator (LFO) to animate the effect. An LFO applied to a chorus effect creates the slight changes necessary for a realistic choral effect. Applied to a flanger, the LFO moves the comb filter notches and adds animation to the sound.

1. Press the **Preset Definition** key. The LED illuminates and the Preset Definition menu appears.
2. Select **Effects** (9). The main Effect screen appears.
3. Select **Preset Effect B** (1). The following screen appears.

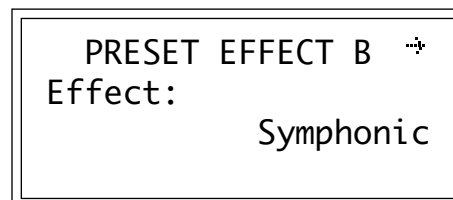

4. Select one of the effects using the data entry control or INC/DEC keys.
5. Press the Right Cursor key. The Effect Parameters screen appears.

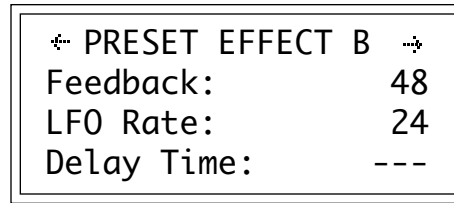

6. Move the Cursor down to the third line and adjust the LFO Rate as desired.
7. Press the Preset Definition key to return to the main menu.

Delay Time

Flanging, chorus and echoes are all based on a delay line where the signal is delayed by some time period and mixed back together with its un-delayed signal. This parameter varies the length of the delay or “how much time” passes before you hear the delayed signal. On some effects, this parameter is not adjustable, indicated by a dash in the field.

1. Press the Preset Definition key. The LED illuminates and the Preset Definition menu appears.
2. Select Effects (9). The main Effect screen appears.
3. Select Preset Effect B (1). The following screen appears.

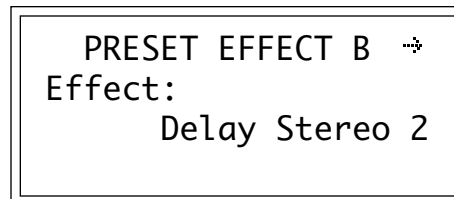

4. Select one of the effects using the Data Entry Control or INC/DEC keys.
5. Press the Right Cursor key. The Effect Parameters screen appears.

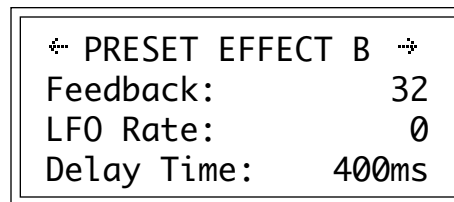

6. Move the Cursor down to the third line and adjust the Delay Time as desired.
7. Press the Preset Definition key to return to the main menu.

FX Amounts

The Effects Amount controls the percentage of effected (wet) signal to un-effected (dry) signal. This function would be analogous to the effects return on a mixing console. The effects amount for each of the four stereo submix outputs can be individually controlled.

1. **Press the Preset Definition key.** The LED will illuminate and the Preset Definition menu will appear.
2. **Select Effects (9).** The main Effect screen will appear.
3. **Select Preset Effect A or B** as desired (0 or 1).
4. **Press the Right Cursor key twice** to access the Sends screen. The Effect Send screen will appear..

* PRESET EFFECT B			
Sends:			
Main:	10%	Sub1:	30%
Sub2:	20%	Sub3:	40%

5. **Adjust the Effect Sends** as desired.
6. **Press the Preset Definition key** to return to the main menu.

Using SCSI

SCSI (pronounced skuzzy) stands for Small Computer System Interface. SCSI is an industry standard hardware and software specification that allows high-speed data transfers between different pieces of equipment. SCSI devices can include hard disks, tape drives, optical disks and other types of digital equipment.

Why Use SCSI?

- **SCSI is fast!** SCSI is a parallel interface which transmits eight bits of information at a time at high speed over the SCSI cable. MIDI, in comparison, is a serial interface which can only send one bit of information at a time over its line.
- **Compatibility:** Since SCSI is an industry standard, equipment from many different manufacturers can be linked to work together.
- **Expandability:** Up to eight SCSI devices can be linked together (the ESI counts as one SCSI device on the chain).

★ **Tip:** Use the "Mount Drives" utility (Master/Global, Disk Utilities, 1) whenever an external SCSI device does not appear in the list of available devices.

The SCSI Bus

You may have noticed that the rear panel of most external storage devices have two SCSI connectors. This is because SCSI devices are connected together in a chain arrangement. The wires that connect the different pieces of equipment are called the SCSI bus.

ID Numbers

Each device on the SCSI bus has its own ID number so that it can distinguish its data from data meant for another device. If data is being saved to a device with ID-2 for instance, all the other devices on the SCSI bus will ignore that data. If two devices have the same ID number, the system will not work. Each device must have its own unique ID number.

! **Caution:** Make sure that no two devices have the same ID number since this can corrupt the startup directories of the Macintosh or the ESI.

The SCSI ID number of the Macintosh is fixed at ID-7 and cannot be changed. The SCSI ID numbers of most other devices can be changed.

Many SCSI devices have hardware defined ID numbers, which means that they have a switch on the front or the back of the unit which allows the ID number to be easily identified and changed.

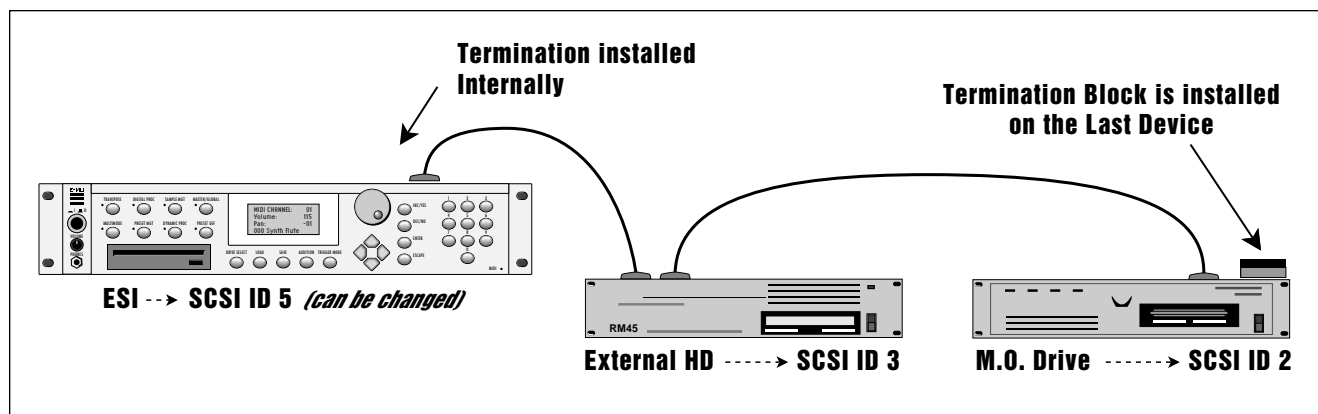

The following is a list of the default SCSI ID numbers:

ID - 7 (fixed)	Macintosh
ID - 6	Unassigned
ID - 5	ESI (this number can be changed)
ID - 4	Unassigned
ID - 3	Unassigned
ID - 2	Internal Iomega 100MB Zip Drive (if installed)
ID - 1	Unassigned
ID - 0	Internal Macintosh HD (if installed)

Types of SCSI Cables

There are two basic types of SCSI cables in use: DB25 and 50-pin Centronics. The two types of cable can be identified by their connectors, which are quite different. When buying SCSI extension cables, it is important to choose ones with the right type of connectors, since the two types will not interconnect without a special adapter. The type of SCSI connectors on the Macintosh are DB25 connectors. These are the type commonly found on the back of personal computers. The SCSI connector on the optional SCSI port is the 50-pin Centronics type. Use only high quality shielded cables that have all the pins connected. Many cables only have some of the pins wired.

★ **Tip:** Always use 50-pin Centronics-type cables with the ESI. These cables have much better electrical characteristics and have fewer problems. Additionally, make sure that all 50 pins of the cables are actually wired. Some SCSI cables have only half of the pins wired.

Terminating SCSI Cables

The total length of the SCSI chain should not exceed 15 feet. A general rule for SCSI cables is: **The Shorter the Better!**

Terminating resistors or terminators are special resistor packs that are installed on the **first and last device in the SCSI chain**. Terminators are used to reduce line echoes or standing waves on the SCSI bus. An analogy in an audio system would be impedance matching.

Terminators can either be hidden inside a SCSI device or they can take the form of termination blocks which can simply be plugged into the SCSI port.

Terminators apply power to an array of resistors which ensure a full 5 volt swing between high and low levels on the SCSI line. The host system is required to provide **Termination Power**. Termination power has its own wire in the SCSI cable and supplies power to the termination block. On external hard disk drives, SCSI terminator power is almost always turned Off and the drives are left un-terminated.

The ESI is shipped with termination power On with the termination resistors left in place. This assumes that the ESI will be placed at one end of the SCSI chain. **The ESI has an automatic system which ONLY supplies terminator power when it is NOT being supplied by another device.** Therefore, you don't need to worry about terminator power when connecting the ESI.

The more devices you have connected to SCSI and the longer your cables are, the more it becomes important to have the cables properly terminated.

! Caution: Turn all devices OFF whenever you change the SCSI cable. Serious damage to the ESI may result from connecting and disconnecting SCSI cables with the power on.

In addition, devices left on when the cable is unplugged may not respond properly until powered off and on.

Using ESI and a Computer on the SCSI Bus

The ESI can now be connected to the SCSI along with another ESI an EIIIIX, or a personal computer. Multiple "Master" devices on the SCSI bus is not normally allowed by the standard SCSI protocol. This is only possible because of ESI's advanced SCSI and **SMDI** (or **SCSI Musical Data Interchange**) implementation. The ESI's SMDI implementation allows sample data to be exchanged over the SCSI bus in a way similar to the MIDI Sample Dump Standard, except **MUCH** faster.

The computer should normally be positioned at one end of the chain and the ESI at the other. The SCSI chain is properly terminated at each end by the computer and the ESI. Devices in the middle of the chain should not have termination resistors installed.

PC Compatibles - The ESI has been tested with IBM PC compatible computers using the Adaptec model 1542C SCSI option card. Sound files can be transferred between a PC computer and the ESI using Sonic Foundry's Sound Forge™ or other sample editing software.

Macintosh - Sound files can be transferred between a Macintosh computer and the ESI using Passport's Alchemy™ or other digital sample editing software. The ESI is able to access approved Macintosh internal CD-ROM drives with CD-ROMs containing ESI compatible files. Similarly, a Macintosh can access an internal ESI Zip drive with a cartridge that has been formatted for the Macintosh.

- The ESI is strictly a "Slave Device" when using SMDI, meaning that it CANNOT initiate SMDI transfers. This should not normally present a problem however, since a computer based editor will always have a facility for initiating SMDI transfers.

★ **Caution:** A sample transferred into the ESI is automatically placed across the entire keyboard, overwriting the current preset's sample placement. Create a new empty preset before downloading via SMDI to avoid trashing the current preset.

- Besides the raw sample data, additional information about the sample is included in a SMDI file.
 - Sample name and number (samples 1-999)
 - Multichannel/Stereo/Mono status
 - Sample length plus one set of loop begin/end points
 - Sample rate, pitch and bit resolution
 - Sample key placement (an E-mu extension to SMDI)

★ **Tip:** You can check the "Memory Available" screen when downloading samples via SMDI to keep track of how much RAM you have left.

! **Caution:** When using Alchemy, you must add **one** to the sample number you want transferred.

! **Caution:** You cannot transfer to or from sample 000 (the clipboard).

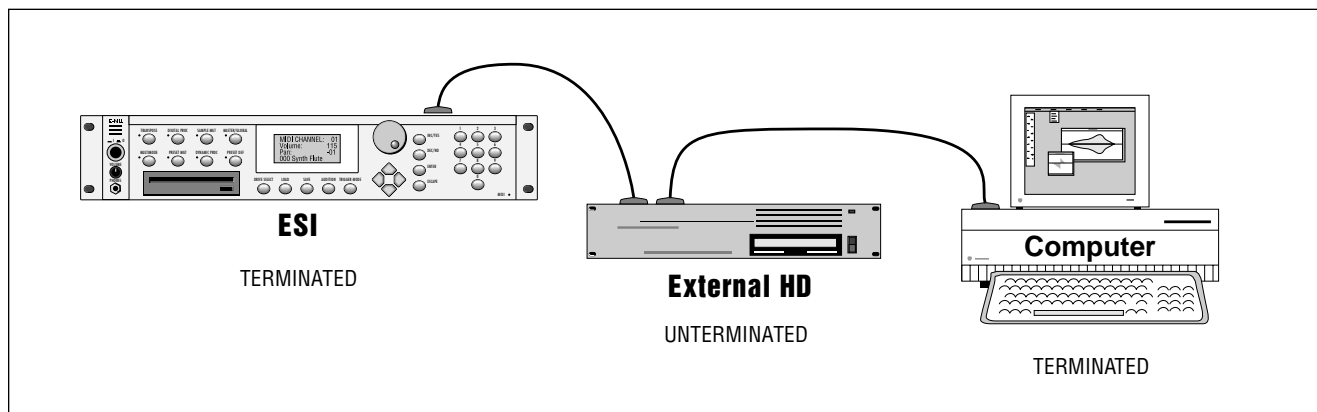

Using Multiple Samplers on the SCSI Bus

ESI version 2.0 software adds arbitration to the SCSI protocol so that multiple “Master” devices can share the bus without a system crash. Two ESI's (an EIIIIX, an e-64, or an E-IV) can share the same sound library, without having to duplicate the storage media.

When connecting your system for use with multiple ESI's, be sure to observe the following rules:

- **NEVER try to write to two devices at the same time or write to one device while loading from another.** Designate one unit as the Master which is the *ONLY* unit allowed to write. Turn Undo Off on all units except the Master. Simultaneous reads are OK.
- Keep SCSI cable lengths as short as possible (Under 12 feet total).
- Make sure that each SCSI device has its own unique ID number. (Remember that the ESI and EIIIIX each use up an ID number in addition to their internal hard disks.)
- Make sure the system is correctly terminated - The ESI's should normally be on the ends of the SCSI chain.

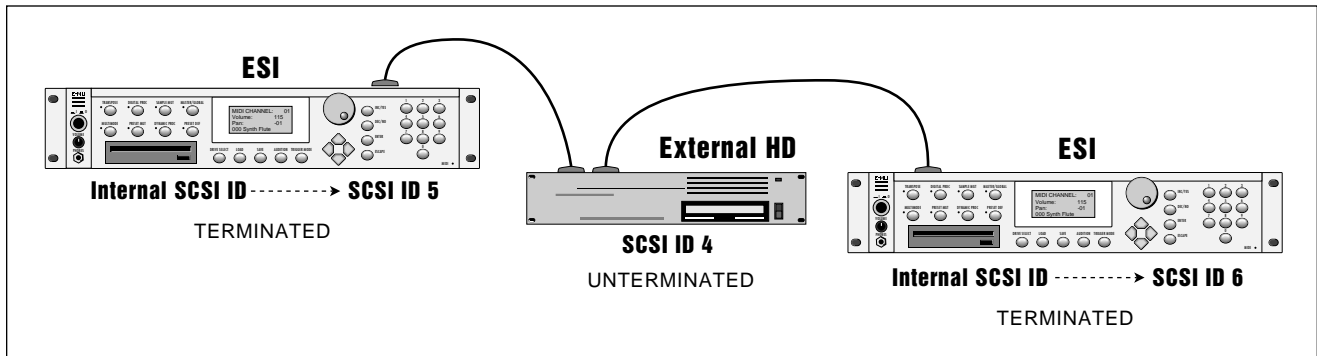

SCSI Problems

In diagnosing SCSI problems the first rule is: Don't panic, *Experiment!* If you have several SCSI devices hooked up, try disconnecting one of the devices and maybe change the order of the units on the line. The following checklist may help you find the solution to your unique SCSI setup.

! Caution: Use the *Install File System* option #8 (see *Master, Format*) when formatting *Imega Zip* drive cartridges. The normal format procedure will not work and corrupts the disk.

1. **Make sure the drive is mounted.** Mount the drives using the Mount Drive utility (Master/Global, Disk Utilities, 1).
2. **Check the SCSI ID numbers.** No two numbers can be the same.
3. **Read the documentation again.** Learn all you can about your peripheral devices. The answer may be right in front of you.
4. **Play with the order in which devices are powered up.** Normally the “Big Bang” method works best (turn everything on at once), but another order may work better in your unique system.
5. **Always suspect the cable when something doesn't work on the SCSI bus.** Remember: The shorter the cables are, the better.
6. **Simplify the situation.** Disconnect one or more drives until you get the system to work.
7. **Are the ends of the SCSI bus terminated?**
8. **If all else fails, call us** at 408-438-1921. Telephone support hours are 9:00 to 5:00 PST, Monday through Friday.

Disk Drive Compatibility Chart

This chart lists the hard disk drives, CD-ROM Drives and Magneto-Optical drives that are compatible for use with the ESI (as of 5-1-95). A current list of compatible disk drives is available on E-mu's web site: (<http://www.emu.com>). If a drive you wish to use is not listed, adhere to the rule, "Try before you buy!". Be sure to check the revision number on the drive in question to make sure it will work with the ESI. A listed drive with a lower revision number than the one shown may not work.

Type	Brand	Model No.	Rev.	Capacity	Type	Brand	Model No.	Rev.	Capacity
HD	Conner	CFA270S	909	270 MB	CDROM	Chinon	CDS-525	V11	650 MB
HD	Conner	CFP1060S	2035	1 GB	CDROM	Matshita	CR 8004		650 MB
HD	Conner	CFP1080S	3939	1 GB	CDROM	Matshita	CR 8005	2.0d	650 MB
HD	Conner	CFP2105S	2847	2.1 GB	CDROM	Plextor	6Plex PX6XCS	1	650 MB
HD	Conner	CFP4207S	2847	4.1 GB	CDROM	Sony	CDU-541		650 MB
HD	DEC	DSP3107LS	X441	1 GB	CDROM	Sony	CDU-8003A	1.9a	650 MB
HD	Fujitsu	M1606S-5	6218	1 GB	CDROM	Toshiba	XM-3101BME		650 MB
HD	Fujitsu	M26848-512		500 MB	CDROM	Toshiba	XM-3501TA	3054	650 MB
HD	Fujitsu	M2915S-512	127	2 GB	CDROM	Toshiba	XM-5201TA	3254	650 MB
HD	IBM	94G3187		1 GB	CDROM	Toshiba	XM-5401TA	3115	650 MB
HD	IBM	DPES 31080 lt	S31K	1 GB	CDROM	Toshiba	XM3601		650 MB
HD	Micropolis	1936-21MZ1007503	MV10.	3.6 GB	CDROM	Toshiba	XM3701TA		650 MB
HD	Micropolis	1991-27SC21020AV	SN05	9 GB	MO	Fujitsu	M2512A		230 MB
HD	Micropolis	2217-15MQ1005101	vx0d	1.7 GB	MO	IBM	0632CHX !F		1.3 GB
HD	Micropolis	4110-09N		1.05 GB	MO	Maxoptix	T3-1304	1.1C	2.1 GB
HD	Quantum	Capela VP32210		2.1 GB	MO	Most	RMD-5200-S	136	250 MB
HD	Quantum	ELS127S	4302	127 MB	MO	Pinnacle	OHD-1300		1.3 GB
HD	Quantum	Empire 1080S	1220	1 GB	MO	Pinnacle	Tahoe 230		230 MB
HD	Quantum	Fireball(SCAM OFF)	1Q09	1 GB	MO	Ricoh	RO-5031E	AO	600 MB
HD	Quantum	Lightning 365		365 MB	MO	Sony	SMO-C501-00	2.07	600 MB
HD	Quantum	Lightning 730S	241E	730 MB	MO	Sony	SMO-C501-00E		600 MB
HD	Quantum	LP240S		240 MB	MO	Sony	SMO-F521-00		1/3 GB
HD	Quantum	LPS270S	5909	270 MB					
HD	Quantum	LPS525S		525 MB					
HD	Quantum	Maverick 540S	905	540 MB					
HD	Quantum	PD1225S		1.2 GB					
HD	Quantum	TRB850S	403	850 MB					
HD	Quantum	XP34301 Grand Prix		4.1 GB					
HD	Seagate	ST-11200N		1 GB					
HD	Seagate	ST15150N	11	4.1 GB					
HD	Seagate	ST31230N	12	1 GB					
HD	Seagate	ST32430N	300	2 GB					
HD	Seagate	ST32550N	16	2 GB					
HD	Seagate	ST410800N	18	9 GB					
HD	Seagate	ST5660N	483	520 MB					
HD RM	lomega	Zip 100	L.27	100 MB					
HD RM	lomega	Jaz 1 GB	G.54	1 GB					
HD RM	Syquest	SQ3105		105 MB					
HD RM	Syquest	SQ3270S	1_14	270 MB					
HD RM	Syquest	SQ5110	N5A	88 MB					
HD RM	Syquest	SQ5200C	AOL	200 MB					
HD RM	Syquest	SQ555		44 MB					

If a drive you wish to use is not listed on this chart, be sure to adhere to the rule, "Try Before You Buy". The chart only represents those drives which have been tested by E-mu Systems, Inc. Many others will also work.

Keyboard Character Map

★ **Tip:** The shaded area represents a standard five octave keyboard range.

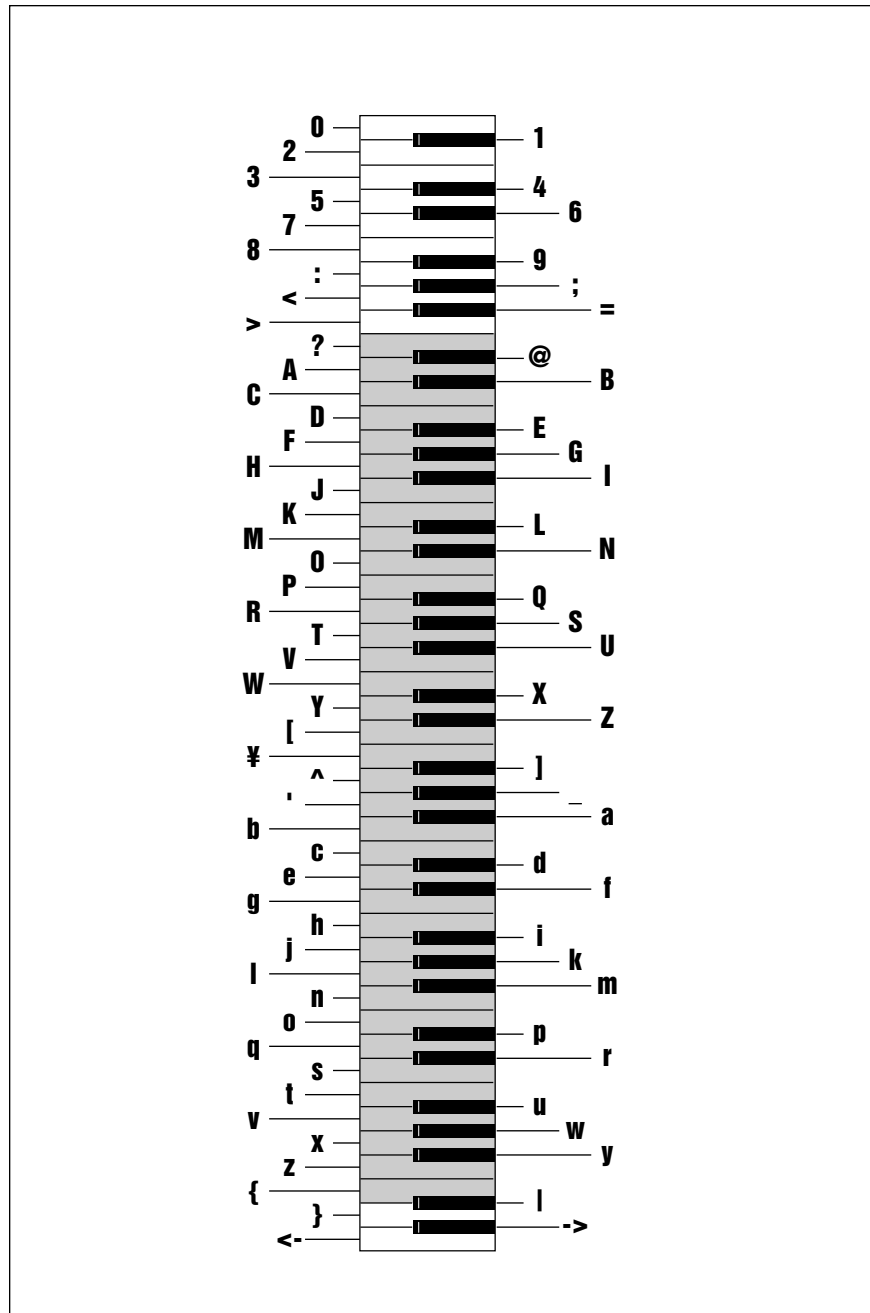

AVAILABLE CHARACTERS. Banks, drives, samples and presets can be named or renamed using these characters. Select the characters using the ten key pad, data entry knob, and keyboard. You can also use the up cursor to insert spaces and the down cursor to delete spaces. There are also additional characters (not shown above) which are only available through use of the data entry knob or increment/decrement buttons.

ESI Menu Map

DYNAMIC PROCESSING
0. Select Zone
1. Analog Setup
2. VCA
3. VCF
4. LFO
5. Auxiliary Envelope
6. Velocity To
7. Keyboard Mode
8. Realtime Control En
9. Output Channels

PRESET DEFINITION
0. Realtime Controls
1. Load Zone
2. Edit Assignment
3. Erase Zone
4. Copy Zone
5. Crossfade/Switch
6. Vel Switch/Link
7. Pitch Bend Range
8. Portamento/Attack

DIGITAL PROCESSING
0. Select Sample
1. Setup
2. Loop
3. Truncation
4. Copy Section
5. Cut Section
6. Paste Section
7. Digital Tools I
8. Digital Tools II
9. Undo

PRESET MANAGEMENT
1. Load Preset
2. Rename Preset
3. Erase Preset
4. Copy Preset
5. Create Preset
6. Preset Size
7. Merge Presets

SAMPLE MANAGEMENT
0. Select Sample
1. Load Sample
2. Rename Sample
3. Erase Sample
4. Copy Sample
5. Sample Setup
6. Place Sample
7. Arm Sampling
8. Force Sampling
9. MIDI Sample Dump

MASTER/ GLOBAL
1. Master Tune
2. Rename Bank
3. Erase Bank
4. Dynamic Allocation
5. Save as EIII Bank
6. Memory Available
7. Disk Utilities
8. Special
9. MIDI
0. Import Options

Digital Tools II
0. Sample Rate Cvt
1. Digital Tuning
2. Digital Compressor
3. Parametric EQ
4. Time Compression
5. Pitch Change
6. Transform Mult.
7. Doppler/Pan

Digital Tools I
0. Sample Calculator
1. Taper
2. Gain Change
3. Reverse Section
4. Stereo <-> Mono
5. Left <-> Right
6. DC Filter
7. Sample Integrity

Special
1. Recalibrate
2. Contrast
3. Headroom
4. Output Format
5. Software Version
6. View Channels
7. Trigger Buttons
8. RAM Test

MIDI
1. MIDI Mix
2. MIDI Globals
3. MIDI Load Bank
4. MIDI Volume Pedal
5. MIDI Volume & Pan
6. Multimode Enable

Basic Channel
MIDI Mode
Cont. Controllers

Disk Utilities
0. SCSI Setup
1. Mount Drives
2. Rename Disk Bank
3. Erase Disk Bank
4. Lock Bank & Drive
5. Disk Status
6. Format Disk
7. Backup & Restore

MIDI Key Numbers

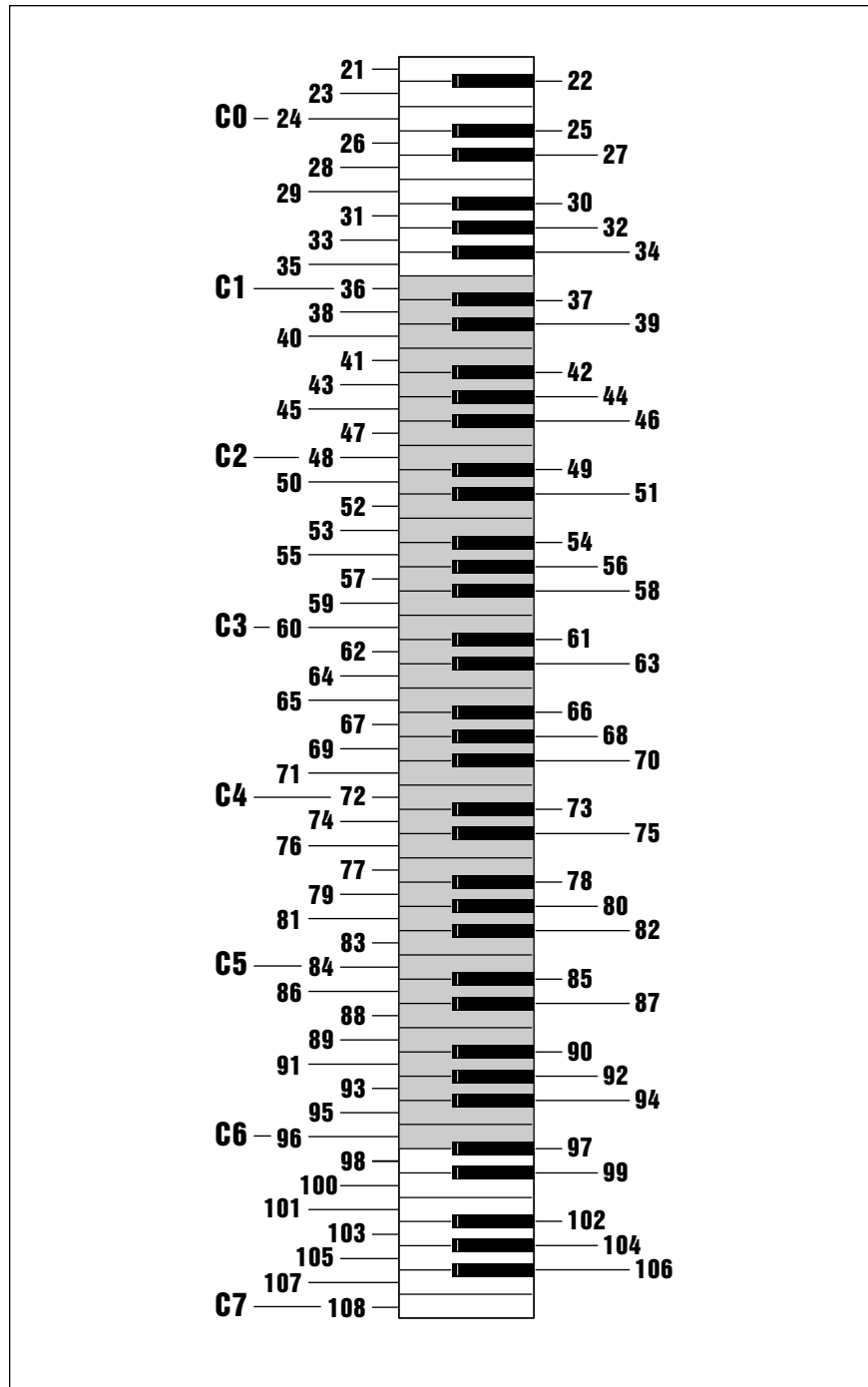

MIDI KEY NUMBERS. The shaded area represents a standard five octave keyboard range.

MIDI Implementation Chart

Function...	Transmitted	Recognized	Remarks
Basic Channel Default Changed	No No	1 1-16	Memorized
Mode Default Messages	No	No	
Note Number True Voice	No No	21-108 (A-1 thru C7) 21-108 (A-1 thru C7)	
Velocity Note ON Note OFF	No No	Yes v=1-127 No	
After Touch Keys Channels	No No	No Yes	
Pitch Bender	No	Yes	
Control Change	No	Yes	0-31 64-79
Bank Select	No	Yes	<i>See note below</i>
Program Change True Number	No No	Yes 0-127 Yes 0-127	
All Sound Off	No	Yes	
All Notes Off	No	Yes	
Reset All Controllers	No	Yes	
System Exclusive	No	No	
MIDI Sample Dump	Yes	Yes	Also xmit/recv SMDI
System Common :Song Pos :Song Sel :Tune	No No No	No No No	
System Real Time :Clock :Commands	No No	No No	
Aux Messages :Local On/Off :Active Sense :Reset	No No No	No No No	
Notes: Pan 0=hard left 127=hard right			
Bank Select: Bn 00 00 20 bb Cn pp (n= MIDI channel, bb = bank#, pp = program in bank)			

Specifications

■ **Note:** Use only 72-pin, low profile SIMMs in the ESI (4 MB, 16 MB or 64 MB). If different size SIMMs are used, the larger SIMM MUST be installed towards the rear of the unit (socket B). The smaller SIMM will be divided in half (you get only half the memory of the smaller SIMM).

Because there are lethal voltages present inside the ESI enclosure, additional sample memory should be installed only by your E-mu dealer or a qualified technician.

Number of Voices	64 mono, 32 stereo
Memory	4 MB standard, 128 MB maximum
Outputs	4 individual 1/4" unbalanced, polyphonic 6 additional with Turbo Option
Output Level	-10 dbm nominal, max 6 volts p-p
Output Impedance	1K Ω
Data Encoding	Input: 16 bit Output: 18 bit
Digital I/O (Turbo Opt.) .	S/PDIF format, RCA connectors
SCSI	50 pin connector, advanced links
Sample Rates	44.1 kHz, 22.05 kHz
Frequency Response	20 Hz to 20 kHz at 44.1 kHz sample rate
THD + N	Less than 0.05%
THD	Less than 0.03%
Signal/Quiescent Noise ...	Better than 100 dB
Stereo Phase	Phase Coherent $\pm 1^\circ$ at 1 kHz
Weight	10 lbs (4.5 kg)
Dimensions	W - 17.125" (43.5cm), H - 3.5" (8.9cm), L - 9.75" (23.7cm)
Power	100-240 VAC, 50/60 Hz, auto-switching supply, less than 30 watts consumption

Error Codes

This section explains some of the error codes you might possibly encounter while working with the ESI. This listing covers only the error codes whose meaning might be confusing or unclear. Most of the error codes explanations in the ESI are readily apparent.

Drive Not Formatted!

Trying to access a hard drive that has not been formatted for the ESI.

FD Data Lost Error!

Bad disk or floppy drive.

FD Data CRC Error!

Bad disk or floppy drive.

FD Data Save Error!

Bad disk or floppy drive.

Floppy Disk Error!

Bad disk or floppy drive.

Floppy Seek Error!

Bad disk or floppy drive.

Insert Unlocked FD!

Floppy disk is locked.

Loop Start (End) Zero!

Sample header is corrupted and needs to be repaired using the "Fix Samples" function.

★ **Tip:** *If the Error Code has the word "Zero" anywhere in it, use the "Fix Samples" utility to repair it.*

Mono Start (End) Zero!

Sample header is corrupted and needs to be repaired using the "Fix Samples" function.

No Samples in Preset!

No samples mapped to any zones.

No Samples Exist!

No samples in bank.

No Presets Exist!

No presets in bank.

No Valid Drives!

1) Conflicting SCSI devices. 2) No SCSI termination at each SCSI cable end. 3) SCSI cable too long. 4) Reboot entire system after changing SCSI cables or ID numbers.

Not Enough Memory

Trying to load in a bank that is too large.

Preset Memory Full!

Not enough preset memory for the operation.

Sample Memory Full!

Not enough sample memory for the operation.

Sample Overload!

A/D converter headroom has been exceeded.

SCSI Bank Locked!

Trying to write to a locked bank.

SCSI Hardware Error!

No HD, Cable, No power, Wrong SCSI ID number.

SCSI Media Error!

Media defect on the hard disk.

Wrong Floppy Number!

Wrong disk in loading sequence.

Wrong Floppy Type!

Sound disk <-> Software Disk.

Troubleshooting

This section explains some of the problems you might possibly encounter while working with the ESI. Before assuming that your ESI is faulty, check the following list which details the corrective action you can take yourself without having to call a service center. If you have any doubts or questions, get in touch with your nearest E-mu dealer or call the E-mu customer service department at (408) 438-1921, between the hours of 8:30 am and 5:30 pm Monday through Friday.

The ESI seems dead

If the ESI seems dead, first disconnect any external SCSI devices and try again.

Problem: The unit is completely dead. No lights no sound.

Cause: The power supply may be damaged.

Solution: Consult your dealer or authorized E-mu service center.

Audio Problems

Problem: The ESI powers up normally, but does not make any sound.

Cause: Proper audio connections may not have been made.

Solution: Try listening directly to the stereo output using headphones to verify that the ESI is at fault. Check that proper audio connections have been made.

Problem: The ESI powers up normally, but does not make any sound.

Cause: The front panel volume control may need recalibration.

Solution: Recalibrate the volume control using the Recalibrate function located under Special in the Master/Global module.

Problem: The ESI powers up normally, but does not make any sound.

Cause: Proper MIDI connections may not have been made.

Solution: Try using the trigger buttons to play the ESI. Check MIDI activity LED. Verify that proper MIDI connections have been made.

Problem: The digital audio output level is too low when a single channel is played.

Cause: Because of the nature of sampling instruments, each additional channel played adds +3 dB to the headroom requirement. A single channel on the ESI comes out about -6 dB down.

Solution: Make sure the Master Volume control is at maximum. Set the headroom adjustment (Master/Global, Special, 3) to 0 dB. All volume adjustments in the ESI affect the digital output level.

Problem: Certain sounds do not play polyphonically.
Cause: The zone may be in solo mode, or only assigned to one output channel.

Solution: Disable solo mode and check output channel assignment.

Problem: Certain sounds cut off prematurely.

Cause: More than 64 mono, or 32 stereo channels are playing. Or, if specific output channels are assigned, two sounds may be “ripping each other off”.

Solution: Check output channel assignment (Dynamic Processing, 9). Try turning Dynamic Allocation (Master/Global, 4) on. Set release times on VCA to a shorter setting.

Problem: Stereo samples are only heard out of one side.

Cause: Disable side function is turned on.

Solution: Turn disable side function (Dynamic Processing, 1) off in the zone.

Problem: Audible hum in system when ESI is connected.

Cause: There is a ground loop present in the audio system.

Solution: Find and eliminate the ground loop.

Functional Problems

Problem: Added RAM SIMMs don't fit with the Turbo Option Kit..

Cause: Using high-profile SIMMs.

Solution: Use only low-profile SIMMs when adding additional memory to your system.

Problem: Front panel buttons double trigger.

Cause: Buttons need cleaning.

Solution: Consult your dealer or authorized E-mu service center.

Problem: Looping only works while in the Digital Processing module.

Cause: Disable Loop function is turned on.

Solution: Turn disable loop function (Dynamic Processing, 1. Setup) off in the zone.

Problem: Controllers (wheels, pedal, pressure) do not work at all.

Cause: Controllers are not assigned in the preset.

Solution: Assign the controllers to the desired destinations (Preset Definition, 0. Realtime Controls).

Problem: Controllers (wheels, pedal, pressure) do not work at all and are assigned correctly.

Cause: Controllers are disabled in Realtime Control Enable section.

Solution: Enable realtime controllers for the selected zone (Dynamic Processing, 8. Realtime Control Enable).

Problem: The footpedal or LFO has little or no effect when assigned to VCA.

Cause: The initial VCA level is set at 100%.

Solution: Lower the initial VCA setting as desired.

MIDI Problems

Since MIDI setups can be quite complex, make sure that you have all the MIDI parameters (on the ESI and external MIDI devices) set correctly before you become daunted. On the ESI, MIDI parameters are located in the Master/Global module, (9. MIDI, 2. MIDI Globals).

Problem: The ESI does not respond to the MIDI parameters as programmed.

Cause: MIDI Globals are turned off.

Solution: Turn on MIDI Globals (Master/Global, 9. MIDI, 2. MIDI Globals).

Problem: The ESI does not respond to the modulation wheels or pressure from an external MIDI controller.

Cause: MIDI controllers are not assigned in the MIDI Globals or Realtime Control submodules.

Solution: Assign proper controller channel numbers to Left Wheel, Right Wheel, Pedal, Pressure, MIDI A and B, then assign MIDI A and B to desired destinations (Master/Global, 9. MIDI, 2. MIDI Globals). Check Realtime Control routings (Preset Definition, 0. Realtime Controls).

Hard Disk Problems

Problem: The ESI does not recognize an external hard disk or other SCSI device.

Cause: The external hard disk or SCSI device was powered-up after the ESI.

Solution: Mount the drives using the Mount Drive function located under Disk Utilities, 1 in the Master/Global module.

- Problem:** The ESI display reads “Disk Not Formatted” and an external SCSI device is connected.
- Cause:** The hard disk may have crashed, the SCSI cable may be too long or two devices may have the same SCSI ID number.
- Solution:** Try using a shorter SCSI cable (maximum cable length is about 12 feet) and check that no two devices have the same ID number.
-
- Problem:** The ESI display reads “SCSI Error!”. There is an external device connected to SCSI.
- Cause:** Two SCSI devices may have the same ID number or an external SCSI device does not have power.
- Solution:** Make sure all external SCSI devices have power. Change one of the SCSI ID numbers. If this fails, try another SCSI cable or another SCSI device if possible.
-
- Problem:** Data from an external SCSI device is being scrambled or lost.
- Cause:** The SCSI cable may be too long, or the device may not be terminated correctly.
- Solution:** Try using a shorter SCSI cable (maximum cable length is about 12 feet) or check that the last device in the SCSI chain has termination resistors installed. See “Using SCSI” in this manual.
-
- Problem:** Iomega Zip cartridges are not being correctly formatted.
- Cause:** Zip drives have a unique type of formatting.
- Solution:** Use the Install File System option #8 (*see Master, Format*) when formatting Iomega Zip drive cartridges. The normal ESI format procedure will not work and corrupts the disk's low level formatting.

Warranty

Please read this warranty, as it gives you specific legal rights.

Length of Warranty

Your ESI warranty covers all defects in materials and workmanship for a period of one year (90 days for disk drives) from the date of purchase by the original owner, provided that the Warranty Registration Card is filled out and returned to E-mu Systems within 14 days from the date of purchase. Cases may arise where E-mu's Service Department or one of E-mu's authorized service centers will ask for a copy of your sales receipt to facilitate warranty service. Please keep your purchase receipt in a safe place.

E-mu Systems does not cover:

Damages due to improper or inadequate maintenance, accident, abuse, misuse, alteration, unauthorized repairs, tampering, or failure to follow normal operating procedures as outlined in the owner's manual. Deterioration or damage of the cabinet. • Damages occurring during any shipment of the ESI for any reason. • An ESI that has in any way been modified by anyone other than E-mu Systems, Inc.

Limitation of Implied Warranties

No warranty is expressed or implied. E-mu Systems specifically disclaims the implied warranties of merchantability and fitness for a particular purpose.

Exclusion of Certain Damages

E-mu Systems' liability for an ESI found defective is limited to repair or replacement of the unit at E-mu's option. In no event shall E-mu Systems Inc. be liable for damages based on inconvenience, whether incidental or consequential, loss of use of the unit, loss of time, interrupted operation or commercial loss, or any other consequential damages.

Some states do not allow limitation of the duration of implied warranties or the exclusion or limitation of incidental or consequential damages, so the above limitations and exclusions may not apply to you.

How To Obtain Warranty Service

All E-mu products are manufactured with the highest standards of quality. If you find that your instrument does require service, it may be done by any authorized E-mu service center. If you are unable to locate a service center in your area, please contact E-mu Systems Service Department at (408) 438-1921. They will either refer you to an authorized service center or ask that you return your ESI to the factory. When returning an ESI to the factory, you will be issued a Return Merchandise Authorization number (RMA). Please label all cartons, shipping documents and correspondence with this number. E-mu suggests you carefully and securely pack your ESI for return to the factory. *(Do not send the power cord or operation manual.)* Mark the outside of the shipping carton clearly with your RMA number. Send to E-mu Systems, Inc. 1600 Green Hills Road, Scotts Valley, California, 95066. You must pre-pay shipping charges to E-mu Systems. E-mu will pay return shipping fees. You will be responsible for any damage or loss sustained during shipment in any direction

8/92

Index

Symbol

110V / 220V Operation 8
2-pole filters 192, 194
2nd order filters 194
4-pole filters 192, 194
4th order filters 194
6-pole filters 192, 194

A

ADC gain 99
A effect types 226
adjust loops 84
adjust the sample range 170
aftertouch control 79
AHDSR envelope 199, 200, 204
Akai™
 import 83
 load 86
 SCSI setup 83
alternate tuning template 197
amplifier, voltage controlled 35, 38
amplitude threshold 150
arm sampling 102
assign group 209
assignable controllers 162
assigning samples to the keyboard 33
assignment
 channel, groups 209
 edit key 169
attack
 time, compressor 142
 VCA 199
 VCF 202
audition button 24
auto
 correlation 118
 normalize 100
 placement 100
 repeat 150
 truncate 100, 122
 velocity to 205
auxiliary envelope 40, 204, 207
available memory 60

B

B effect types 226
backup 60, 67
 bandpass filter 194
backwards talking game 50
bandwidth, EQ 146
bank 13
 confirm new 85
 definition 13

 erasing 58, 60, 63
 exporting 59
 loading 23, 29
 loading from a hard disk 31
 loading MIDI 76, 81
 locking 60, 63
 management 54
 renaming 57, 60, 62
 saving 23
bat-phaser filter 195
beep tone 122
boost
 headroom 70, 72
 output 73
boost/cut 193
boot in multimode 82
bottom feeder filter 195
bus, effects 216, 217
busses by zone, submix 222
bypass, effects 225

C

calculator, sample 131
CD-ROM 14
change
 filter cutoff envelope 37
 filter cutoff frequency 36
 filter Q
 gain 51, 133
 receiving MIDI program 23, 78
 original key 198
 pitch 53, 138, 147
channel assignment 211
channel view 70, 74
channel settings in multi mode 224
channels, MIDI 78, 221, 222
chorus effect 228, 233
 by doubling 197
clear path, doppler 153
clipboard 117
collect memory 60
combine L/R 85
compression 142
 loop 115
 musical, digital compressor 144
 ratio, digital compressor 142
 time 138, 146
compressor
 compression ratio 142
 dynamic range 138
 mode, peak 142
 musical compression 144
confirm new bank 85
connect external hard disk 30

- connection 8
 - SCSI 236
- connector, SCSI 9, 245, 236
- continuous controller 79, 161
- contrary bandpass filter 194
- contrast 70, 71
- control
 - destination 163
 - mod 79
 - pedal 79
 - pitch 79
 - pressure 79
 - realtime 42
 - source, selecting 43
- controllers
 - assignable 162
 - continuous 161
 - enable 208
- convert
 - sample rate 138, 139
 - stereo to mono 131, 135
- convolution *See transform multiply*
- copy
 - path 151
 - preset 109
 - region 126
 - zone 173
- correlation, auto- 118
- create preset 110
- crossfade
 - looping 116, 124
 - positional 176, 177
 - realtime 164, 177
 - pasting 130
 - velocity 176, 177
- cross-switch 165, 176, 179
- current preset 15, 22
- current sample 15, 33
- cursor 16, 22
- cursor/page buttons 22
- curve
 - gain change 134
 - taper 133
- cut and paste 50
- cut frequency, boost/ 146, 193
- cut region 50, 127
- cutoff frequency 35, 191, 200
 - changing 36

D

- damping, high frequency 227, 231
- data entry control 16, 21
- data
 - backing up 67
 - restoring from backup 69
 - saving to a floppy disk 29
 - saving to a hard disk 30
- DC filter 131, 136
- decay
 - time, reverb 227, 230
 - VCA 199
 - VCF 202
- decrement button 16
- default setting 16
- delay effect 229
- delay
 - LFO 202
 - zone 197
- delay, effects processor
 - panning 229
 - programs 227
 - stereo 229
 - time 234
 - vibrato 229
- destination
 - footswitch 43, 165
 - modulation 43
 - modulation wheel 42
 - selecting 43
- digital input 99
- digital
 - processing 11, 114
 - tools I 131
 - tools II 138, 140
 - tuning 138, 140
- dimensions 245
- disable loop 198
- disable side 198
- disk
 - backing up 60
 - drive 13
 - external drives 14
 - floppy 13
 - formatting 60, 65
 - formatting a floppy 29
 - formatting read/write optical 66
 - hard 9, 14
 - status 60, 64
 - utilities 60
- distortion effect 229
- distortion specification 245
- doppler/pan 149
- doubling 228

- drive
 - CD-ROM 14
 - external 14
 - floppy disk 13
 - hard disk 14
 - locking 60, 63
 - magneto-optical 14
 - mounting 60, 62
 - select button 24
- dual effects processors 216
- dual tap delay 229
- dynamic processing 11, 35, 189
- dynamic range
 - adjusting 72
 - compression 142
 - expansion 142
- dynamic setup 197

E

- edit
 - assignment 169
 - doppler path 153
- effects
 - amount, preset 235
 - bus 216
 - bypass 225
 - chorus 233
 - control 218
 - control channel 224
 - flange 233
 - master 219
 - master in multi-mode 220
 - master/global 219, 220
 - only mix 217, 221
 - processors, dual 216
 - programmed in the preset 218
 - sends 216
 - types, A/B 226
- Emax II
 - import 83, 89
 - load 89
 - SCSI setup 89
- enabling
 - multimode 82
 - the loop 121
 - realtime controls 208
- enhancer, sonic 155
- enter 21
- envelope
 - generator 37-40, 199, 201, 204
 - inverted 37
 - mode 208
 - trigger (gate) 207
- equal power

- crossfade looping 124
- crossfading 130
- mix in paste 129
- equalizer, parametric 138, 145
- erase
 - bank 58
 - disk bank 60, 63
 - preset 54, 109
 - sample 97
 - zone 172
- error codes 246
- escape button 21
- ESI turbo option 215
- ESI/E3X lowpass filter 195
- expansion, dynamic range 142
- export functions (bank) 59
- external drives 14
 - hard disk, connecting 30

F

- fade in/out
 - gain change 134
 - sonic enhancer 155
 - taper 132
- Fc 35, 191
- feedback, delay 229
 - amount 233
- filters 190
 - background 190
 - changing the cutoff frequency 36
 - DC 131, 136
 - ESI/E3X lowpass 195
 - guided tour 35
 - parametric 193
 - Q 36, 192
 - reconstruction 139, 140
 - realtime control of 163
 - swept EQ 193
 - types 194-195
 - VCF tracking 200
 - voltage controlled (VCF) 200
 - Z-plane 193
- fix samples 137
- flange effects 233
- flanger 228
 - lite filter 195
- flip path, doppler 152
- floppy disk 13
 - saving data to a 29
- footswitch
 - assignments 80
 - destinations 43, 165
- force sampling 102

- format
 - disk 60, 65
 - external hard disk 30
 - floppy disk 29
 - hard disk 9, 66
 - read/write optical disks 66
 - selecting output 73
- fragment, memory 60
- frequency
 - changing the filter cutoff 36
 - cutoff 35, 191
 - interpolation filter 139
 - LFO 202
 - sampling 10, 99
- full placement, Akai import 85
- FX B through FX A 231
- FX output 215

G

- gain
 - change <->, 133
 - sample input 99
- gated reverbs 227
- generator, envelope 37-40, 199, 201, 204
- global effects 219, 220, 224
- global MIDI functions 76, 78

H

- hall programs, reverb 227
- hard disk 9, 14
 - backing up 67
 - connecting an external 30
 - formatting 9, 30, 66
 - interleave 66
 - loading a bank from 31
 - problems 250
 - saving data to a 30
- headphone output 6
- headroom/boost 70, 72, 73
- high frequency damping 227, 231
- highpass filter 194
- hold, VCA peak duration 199
- hold, VCF 202

I

- import
 - Akai 83
 - Emax II 83, 89
 - functions 83
- increment/decrement buttons 16
- increment/decrement presets 165

- insert mode, paste 129
- insufficient drive memory 117
- integrity, sample 137
- interface, MIDI 78
- interleave, hard disk 66
- inverted envelopes 37

K

- key, changing the original 198
- keyboard
 - keys, linking to samples 33
 - mode 207
 - notes, triggering 70
 - transposing the 32

L

- latch mode 74, 75
- layer, primary/secondary 15
- LCD, changing viewing angle 71
- left <-> right 131, 136
- length, changing sample 149
- length, sampling 100
- LFO 39, 229
 - routing 202-203
- limiter 144
- linear
 - crossfade looping 124
 - crossfading 130
 - mix, pasting 129
- link presets 183
- load
 - bank 23
 - preset 107
 - sample 95
 - zone 166
- loading
 - a bank 29
 - a bank from a hard disk 31
 - a preset 54
- lock bank and drive 60, 63
- loop
 - adjusting 84
 - compression 115
 - crossfade 116, 124
 - enable 121
 - in release 121
 - setup 122
 - single cycle 131
- looping
 - a sample 48, 114, 123
 - crossfade 116, 124
- low freq. oscillator 39, 202, 233
- lowpass filters 36, 191, 194

M

- magneto-optical drive 14
- main effects bus 216
- main output format 70, 73
- master
 - effects 219
 - effects settings in multimode 220
 - /global module 55
 - tune 57
 - volume 21
- memory 60
 - insufficient system drive 117
 - testing 70, 75
 - type 245
- menu map chart 242
- merge presets 111
- MIDI
 - A/B control 79
 - basic channel 78
 - bank select 244
 - channel 78, 221, 222
 - connection 8
 - continuous controller number 79
 - global 76, 78
 - implementation chart 244
 - in 8
 - key number chart 243
 - load bank 76, 81
 - mix 76, 77
 - mode 78
 - multi mode 25, 82, 216
 - out 8
 - poly mode 209
 - problems 250
 - program change 23, 78
 - sample dump 103
 - thru 8
 - volume pedal 81
 - volume pedal global override 76
 - volume/pan 76, 82
 - mix in paste, linear 129
- mod control 79
- mode
 - envelope 208
 - insert (paste) 129
 - keyboard 207
 - MIDI 78
 - mono A-1 210
 - multi 25, 78
 - transpose 25
 - trigger 24
- modulation destinations 42, 43
- module 15
- monitor through while sampling 100
- mono A-I mode 210

- morphing filter 193
- mount drives 60, 62
- multi tap effect programs 227
- multimode 25, 78
 - button 25
 - channel settings 224
 - enable 82
- multiply, transform 138
- musical compression 144

N

- noise reduction 144
- nontranspose function 207, 208
- normalize
 - automatically 100
 - gain change 134

O

- offset path, doppler 152
- options
 - ESI turbo 215
 - hard disk interleave 66
 - turbo 8
- original key, changing 198
- oscillator, low frequency 39, 233
- output
 - boost 73
 - connection 6
 - format, selecting 73
 - headphone 6
 - impedance 245
 - level 245
 - main 70
 - FX 215
 - submix 6
 - turbo option 6, 215

P

- pan
 - doppler/ 138, 149
 - MIDI volume/ 76
 - realtime 163
 - VCA 198
- panning delay, effect 229
- parametric
 - EQ bandwidth 146
 - equalizer 138, 145
 - filters 193
 - swept EQ* 194-195
- paste
 - cut and 50
 - mode, insert 129
 - region 51, 128

- path, doppler
 - clear 153
 - copy 151
 - duration 150
 - edit 153
 - flip 152
 - manager 151
 - offset 152
 - reverse 152
- peak
 - compressor mode 142
 - hold, envelope 199
- pedal
 - control 79, 161
 - MIDI volume 76, 81
- phaser filters 195
- pitch
 - bend range 184
 - bending 42
 - change 53, 138, 147
 - control 79
- place sample 101
- placement, auto 100
- placement, sample 49
 - rule 100
- plate reverb programs 227
- poly all mode, channel assignment 209
- port, MIDI 8
- portamento 184
- positional crossfade 176, 177
- power requirement 245
- power, RMS 142
- practice sampling session 48
- presampling time 99
- preserve order, Akai import 85
- preset 12
 - copy 109
 - create 110
 - current 15, 22
 - definition 12
 - erase 54, 109
 - increment/decrement 165
 - link 183
 - load 107
 - merge 111
 - rename 108
 - selecting 22, 31
 - size 111
 - templates, creating 101
- pressure (aftertouch) 79
- primary and secondary layers 15
- processors, dual effects 216
- program *See also:* Preset
 - change, MIDI 23, 78
 - effects 227

Q

- Q 35, 36, 192, 200
 - VCF note on 164
- quick zone 190

R

- RAM capacity 245
- RAM test 70, 75
- range
 - pitch bend 184
 - velocity 178, 182
- rate
 - LFO
 - preset LFO* 202
 - effect LFO* 233
 - portamento 184
 - sample 99
 - sample rate convert 139
- ratio
 - dynamic compression 142
 - time compression 146
- realtime
 - control 42, 161
 - crossfade 177
 - switch 178
- recalibrate 70, 71
- reconstruction filter 139
- redo 117
- reduction , noise 144
- region
 - copy 126
 - cut 127
 - cutting a 50
 - paste 128
 - pasting a 51
- release
 - time, compressor 142
 - VCA 199
 - VCF 202
- remaining memory 60
- rename
 - bank 57
 - disk bank 60, 62
 - preset 108
 - sample 96
- resonance 192 *See also:* Q
- restore disk 69
- reverberation 227
- reverse doppler path 152
- reverse section 135
- right channel, sample setup 99
- RMS, compressor mode 142
- room reverb programs 227
- routings, submix bus 217

S

- S/PDIF 8, 215
- sample
 - adjusting keyboard range 170
 - assigning to keyboard keys 33
 - calculator 131
 - current 15, 33
 - data word size 103
 - definition 11
 - dump, MIDI 103
 - erase 97
 - input 8
 - integrity 103, 131, 137
 - length 100
 - time compression* 146
 - loading 95
 - looping a 48, 114-116, 123
 - monitor 100
 - placement 49
 - rule* 100
 - rate 99
 - rate convert 138
 - renaming 96
 - reverse 131
 - select 121
 - selecting 95
 - setup 99
 - source 99
 - start 206
 - truncating 47
 - fix 137
 - truncating 125
- sampling 10, 45
 - arm 102
 - basics 10
 - force 102
 - level 99
 - monitor through while 100
 - practice session 48
 - presample times 99
 - rate 99
 - terminate 102
 - threshold 99
 - time (recording) 100
- saving
 - as E3 bank 59
 - as v1.04 floppy 59
 - as v2.10 bank 59
 - bank 23
 - data to a floppy disk 29
 - data to a hard disk 30
- sawtooth, LFO waveform 202
- scrub wheel 120
- SCSI
 - Akai™ sampler connection 83
 - avoid host on ID 61
 - background 236
 - connecting a drive 9, 236
 - Emax II connection 89
 - ESI SCSI ID 61
 - ID number 9, 236
 - problems 239
 - setup 61
 - using 236
 - secondary layer 15
 - section, reverse 135
 - select zone 196
 - selecting
 - control source & destination 43
 - drive 24
 - presets 22, 31
 - samples 95, 121
 - zero crossing points 22
 - zones 12, 196
 - send amounts, effects 216
 - settings, default 16
 - setup, sample 99
 - setup, SCSI 61
 - shape, LFO 202
 - shift, doppler pitch 149
 - sine, LFO waveform 202
 - single cycle loops 131
 - size
 - bank 60
 - preset 111
 - slapback, effect 228
 - SMDI 238
 - software version 70, 74
 - solo mode 207, 208
 - sonic enhancer 155
 - source, sample 99
 - sources, control 43
 - special functions 70
 - specifying the zone 34
 - square, LFO waveform 202
 - status, disk 60, 64
 - stereo
 - to mono conversion 131, 135
 - delay 229
 - effects processors 215
 - jacks 215
 - outputs 6, 7, 215-217
 - sampling 99, 126
 - sub effects bus 216
 - submix 211
 - bus routings 217
 - busses by zone 222
 - outputs 6

- submodule 15
- sustain, envelope 199
- sustain, footswitch 165
- swap left and right 131, 136
- swept EQ 193-195
- switch
 - crossfade/ 179
 - realtime 178
 - velocity 176, 177

T

- taper 51, 132
- templates, creating
 - alternate tuning 197
 - preset 101
- ten key pad 21
- terminate sampling 102
- termination, SCSI 237
- testing memory 70
- threshold 99, 142
 - doppler 150
 - compressor 144
 - sampling 99
 - zero crossing 122
- time compression 146
- tracking, filter 200
- transform multiplication 148
- transpose 25, 57
 - keyboard 32
 - zone 171
- transposition 11
 - range 100
- triangle, LFO waveform 202
- trigger
 - buttons 70
 - envelope 207
 - keyboard notes 70
 - mode 24
- trimming samples 125
- truncate sample 125
- truncate, auto 100
- truncating a sample 47
- tune
 - master 57
 - sonic enhancer 155
- tuning
 - alternate template 197
 - digital 138, 140
 - dynamic setup 197
 - ESI to other instruments 32
- turbo option 8

U

- undo 117, 156
- utilities, disk 60

V

- VCA 38, 198
 - envelope 199
 - level 198
 - pan 198
 - realtime control of attack 164
- VCF 35, 200
 - cutoff 200, 206
 - envelope 35, 37, 201
 - note on Q 264
 - Q 206
- variation, LFO 203
- velocity 205
 - cross-switch function 183
 - crossfade 176, 177
 - range 178, 182
 - crossfade 180
 - switch 176, 177
 - switch/ preset link 180
 - to 205
 - understanding 41
- version, software 70, 74
- vibrato delay effect 229
- view channels 70, 74
- viewing angle, LCD 71
- vocal Ah-Ay-Ee filter 195
- vocal Oo-Ah filter 195
- voltage
 - AC settings 8, 245
 - controlled amplifier 35, 38, 198
 - controlled filter 200
- volume
 - master 21
 - MIDI pedal 81
 - pan MIDI 82
 - pedal, MIDI 76
 - recalibrate 71

W

- warranty 252
- waveform, LFO 202
- weight 245
- wet/dry mix effects sends 216

Z

- Z-plane filter 193
- zero crossing 22, 118
- zero X threshold 118, 122
- Zip drives, formatting 66
- zone 12, 34, 189
 - copying 173
 - definition 12
 - erasing 172
 - level 198
 - loading a 166
 - quick 190
 - selecting 12, 196
 - specifying 34
 - submix busses by 222
 - transposing 171

E-MU SYSTEMS INC. WARRANTY REGISTRATION

Please take the time to fill out this warranty card so that we can keep you informed of upgrades and updates for your new E-mu System's product. In addition, if you should require technical support or warranty service in the future we will require that your product be registered in our system. You can also register on-line at www.emu.com, by phone at (408) 438-1921 or by fax at (408) 439-0389. We look forward to hearing from you today!!

Product Name: _____

Model Number: **Serial Number:**

DATE PURCHASED: _____ **DEALER'S NAME:** _____

YOUR NAME: _____ **TELEPHONE:** _____

ADDRESS: _____ **CITY:** _____

STATE/PROV: _____ **COUNTRY:** _____ **ZIP/POST CODE:** _____

YOU COULD ALSO HELP US IMPROVE OUR PRODUCTS AND SERVICE BY TAKING THE TIME TO ANSWER A FEW QUESTIONS!!!

Use this Warranty Registration card if you live in North, Central or South America.

If you live in Europe, you will find a European Warranty card in your ESI box.

1. Is this your first piece of E-mu gear? If no, what other E-mu gear do you own?
2. What influenced your decision to buy this particular E-mu product (i.e. recommendation, price, features, sounds, etc.)?
3. How did you first hear about this product? If through advertising, what magazine?
4. What are the most important features to you on this product? The least important?
5. Briefly describe your studio or setup. Do you own a computer that you will be using with this piece of gear, if so, what brand?
6. We value your input very highly. Do you have any suggestions on how we can make this product better? Is there anything else that you require from E-mu Systems?

* Office Use Only *

Please fold this card along the dotted line and return within 10 days of your purchase. Thank-you!

Fold Here

AFFIX
PROPER
POSTAGE
HERE

E-mu Systems, Ltd.
1600 Green Hills Road
P.O. Box 660015
Scotts Valley, CA 95067